

Central Liquidity Management

User Detailed Functional Specifications

Author 4CB

Version R2023.NOV

Date 22 September 2023

Table of contents

List of Figures	14
List of Tables	18
Reader's guide	29
Introduction	31
Part I - General features of CLM	32
1 Overview of CLM	32
2 Access to CLM	35
2.1 Connectivity	35
2.2 Authentication and authorisation process in CLM	36
2.3 Security	37
2.3.1 Confidentiality	37
2.3.2 Integrity	37
2.3.3 Availability	38
2.4 Graphical User Interface	38
2.5 Communication between CLM and CLM Actors	38
3 Parties and accounts	44
3.1 Parties	44
3.1.1 Set-up of parties	44
3.1.2 Concept of party in CLM	45
3.1.3 CLM - specific party service link	46
3.1.4 Reference data for parties used by CLM	47
3.1.5 Blocking/unblocking party	47
3.2 Accounts structure and functionalities	48
3.2.1 Account types	49
3.2.2 Reference data for accounts used by CLM	54
3.2.3 Functionalities	54
3.2.4 Messaging	59
3.2.5 Blocking/unblocking account	60
3.2.6 Closing of accounts still containing a balance	61
3.3 Static data configuration for minimum reserve management and interest calculation	61
3.4 Types of groups	65
3.5 Shared reference data	68
3.6 Local reference data	71
3.7 Interaction between CLM and CRDM	71
4 Business day	73

4.1 T2 calendar.....	73
4.2 CLM schedule.....	75
4.3 Overview description of the business day.....	76
4.4 Detailed description of the business day.....	80
4.4.1 Start-of-day period (18:45 - 19:00 CET).....	80
4.4.2 CLM RTS period (19:00 - 18:00 CET).....	82
4.4.2.1 Settlement window for CBOs	83
4.4.2.2 Settlement window for liquidity transfer orders	84
4.4.2.3 "Cut-off for CLM RTS"	85
4.4.3 Maintenance window	86
4.4.4 End-of-day period (18:00 - 18:45 CET).....	87
4.4.5 Currency specific closing.....	90
4.5 List of events	91
5 Business and features description.....	93
5.1 File and message processing.....	93
5.1.1 Overview.....	93
5.1.2 Technical validation	93
5.1.3 Business validation.....	94
5.2 Cash transfer orders and cash transfers in CLM	94
5.3 Cash transfer order processing	95
5.3.1 Processing of CBOs	95
5.3.2 Definition of execution time	98
5.3.3 Warehoused payment orders	100
5.3.4 Flow of payment orders.....	100
5.3.4.1 Payment orders initiated by CBs - credit transfer order	100
5.3.4.2 Payment orders initiated by CB - direct debit order	102
5.3.5 Rejection of cash transfer orders	104
5.3.6 Modification of payment orders	105
5.3.7 Revocation of payment orders	106
5.3.8 Processing of cash transfer orders	107
5.3.8.1 Effective settlement/execution order	107
5.3.8.2 Entry disposition	107
5.3.8.3 Comprehensive queue management.....	114
5.3.8.4 Dissolution of the payment queue.....	116
5.3.9 Cash transfer order processing times	116
5.4 Liquidity management	118
5.4.1 Available liquidity.....	118
5.4.2 Liquidity transfer	119
5.4.2.1 Overview	119
5.4.2.2 Execution of liquidity transfers	122
5.4.2.3 Liquidity transfer process	124

5.4.2.3.1 Immediate inter-service liquidity transfer from a CLM (CB) Account to a dedicated account in a different settlement service.....	124
5.4.2.3.2 Immediate intra-service liquidity transfer between two CLM Accounts	126
5.4.2.3.3 Immediate inter-service liquidity transfer between two dedicated accounts in different settlement services.....	128
5.4.3 Liquidity management features	129
5.4.3.1 Automated liquidity transfer due to queued/pending CBO.....	129
5.4.3.2 Liquidity reservation	130
5.4.3.2.1 Overview	130
5.4.3.2.2 Effect and tapping of liquidity reservation	132
5.4.3.3 Floor/ceiling	134
5.4.3.3.1 Definition of floor/ceiling threshold	134
5.4.3.3.2 Breach of floor/ceiling threshold - notification	136
5.4.3.3.3 Breach of floor/ceiling threshold – rule-based liquidity transfer	136
5.5 Minimum reserve management and interest calculation.....	139
5.5.1 Overview.....	139
5.5.2 Collection of EoD balances	142
5.5.3 Daily calculations.....	142
5.5.4 Periodic calculations.....	143
5.5.5 Generate payment orders	144
5.6 Standing facilities management	144
5.6.1 Overnight deposit	145
5.6.2 Marginal lending on request.....	146
5.6.2.1 Overview	146
5.6.2.2 Before launch of ECMS.....	147
5.6.2.3 After launch of ECMS.....	148
5.6.3 Automatic marginal lending	149
5.6.3.1 Overview	149
5.6.3.2 Before launch of ECMS.....	149
5.6.3.3 After launch of ECMS.....	150
5.7 Information management for CLM.....	151
5.7.1 CLM status management	151
5.7.1.1 Concept	151
5.7.1.2 Overview	151
5.7.1.3 Status management process	152
5.7.1.3.1 Status communication and types	152
5.7.1.3.2 CLM file status	152
5.7.1.3.3 CLM message status	153
5.7.1.3.4 Cash transfer status	155
5.7.1.3.5 Task queue order status	157
5.7.2 CLM report generation	161
5.7.2.1 Concept	161

5.7.2.2 Overview	162
5.7.2.3 Report generation process	162
5.7.3 Query management for CLM	164
5.7.3.1 Concept for CLM	164
5.7.3.2 Overview for CLM	165
5.7.3.3 Query management process for CLM	165
5.7.3.4 Specificities for delta set queries	167
5.7.4 Broadcasts	168
5.7.4.1 Settlement-related broadcasts	168
5.7.4.2 Operations-related broadcasts	169
5.8 Provisioning of data for Billing	169
5.9 The life cycle of a business case	169
5.9.1 Concept	169
5.9.2 Business Case ID specificities	170
5.9.3 Business case codes and their usage	170
5.10 Impact of blocking on the processing of cash transfer orders	171
5.11 Cash Transfer Category and Business Case Codes for various features	172
6 Overview of used common components in CLM	176
6.1 CRDM	176
6.2 Data Warehouse	177
6.2.1 Functional overview	178
6.2.2 Interaction with CLM	179
6.3 Billing	180
6.4 Legal Archiving	181
6.4.1 Legal Archiving management	181
6.4.2 General features of Legal Archiving	181
6.5 ESMIG	182
6.6 Business Day Management	183
6.7 Contingency Services	183
7 Operations and support	185
7.1 Business application configuration	185
7.2 Business and operations monitoring	185
7.3 Trouble management	185
8 Additional information for CBs	187
8.1 Role of CBs in CLM	187
8.2 Processing of cash transfer orders - specific functions for CBs	188
8.2.1 Functions in relation to their community	188
8.2.2 Central bank operations	188
8.2.3 Seizure of funds	189
8.3 Credit line management	190

8.3.1 Credit line modifications	190
8.3.2 Connected payment	191
8.4 TARGET Services general ledgers	192
8.4.1 Collection of general ledger data and sending to CBs by CLM	192
8.4.2 Content of TARGET Services general ledgers	194
8.4.3 General ledger provisioning and format	196
8.5 Cross-CB turnover	197
8.5.1 Overview	197
8.5.2 Calculation of multilateral turnover	197
8.5.3 Numeric examples	198
8.6 Query management - CB specific queries	200
8.7 Business/liquidity monitoring for CBs	201
8.8 Minimum reserve management and interest calculation - specific functions for CBs	202
8.8.1 Maintain minimum reserve requirement	202
8.8.2 Insert or adjust balance for minimum reserve fulfilment	202
8.8.3 Administrate minimum reserve penalty	203
8.9 Standing facilities - specific functions for CBs	203
8.10 Specific requirements for out-CBs	204
8.11 Contingency settlement - ECONS II	204
8.12 Contingency upload of A2A files and messages in U2A	205
Part II - Dialogues with the CLM Actor	207
9 Processes with CLM	207
9.1 Send CLM file	209
9.1.1 Description	209
9.1.2 Messages	211
9.2 Send CLM message	211
9.2.1 Description	211
9.2.2 Messages	213
9.3 Process CLM payment order and liquidity transfer order	213
9.3.1 Description	213
9.3.2 Messages	216
9.4 Perform CLM payment order revocation	216
9.4.1 Description	216
9.4.2 Messages	218
9.5 Execute CLM standing order	219
9.6 Settle standing order in CLM	220
9.6.1 Description	220
9.6.2 Messages	223
9.7 Perform standard CLM settlement	223
9.7.1 Description	223
9.7.2 Messages	235

9.8 Process automated liquidity transfer order with intermediate status.....	235
9.9 Process CLM floor and ceiling.....	237
9.9.1 Description.....	237
9.9.2 Messages	239
9.10 Process CLM reject time	239
9.11 Initiate CLM reject time broadcast.....	240
9.12 Process CLM reject time broadcast	241
9.12.1 Description	241
9.12.2 Messages	242
9.13 Settle connected payments.....	243
9.13.1 Description	243
9.13.2 Messages	247
9.14 Modify credit line	247
9.14.1 Description	247
9.14.2 Messages	251
9.15 Reject pending credit line modification.....	252
9.15.1 Description	252
9.15.2 Messages	253
9.16 Manage current reservation in CLM.....	253
9.16.1 Description	253
9.16.2 Messages	257
9.17 Reject pending reservation modification in CLM.....	257
9.17.1 Description	257
9.17.2 Messages	259
9.18 Reject payment order	259
9.18.1 Description	259
9.18.2 Messages	260
9.19 Process interest for accounts subject to interest calculation	260
9.20 Coordinate general ledger creation with other settlement services	263
9.20.1 Description	263
9.20.2 Messages	265
9.21 Process cross-CB turnover	266
9.22 Business day event processes.....	267
9.22.1 Process business day event “Change of business day”	267
9.22.2 Process business day event “Start of CLM RTS”.....	269
9.22.3 Process business day event “Cut-off for CLM RTS”	270
9.22.4 Process business day event “Start of EoD processing”.....	272
9.22.5 Process business day event “CB cut-off for standing facilities”	272
9.23 Processing of standing facilities	275
9.23.1 Process overnight deposit - setting up order.....	275
9.23.2 Process overnight deposit - reverse order	275
9.23.3 Process overnight deposit - refund and interest.....	276

9.23.4 Process marginal lending on request - setting up order	278
9.23.4.1 Before launch of ECMS.....	278
9.23.4.2 After launch of ECMS.....	279
9.23.5 Process marginal lending on request - reverse order	279
9.23.5.1 Before launch of ECMS.....	279
9.23.5.2 After launch of ECMS.....	280
9.23.6 Process automatic marginal lending - setting up - before and after launch of ECMS	280
9.23.6.1 Description	280
9.23.6.2 Messages	282
9.23.7 Process marginal lending - reimbursement and interest.....	282
9.23.7.1 Before launch of ECMS.....	282
9.23.7.2 After launch of ECMS.....	285
9.24 Processing of minimum reserve and interest	285
9.24.1 Maintain minimum reserve requirement order	285
9.24.1.1 Description	285
9.24.1.2 Messages	287
9.24.2 Insert or adjust balance for minimum reserve fulfilment	287
9.24.2.1 Description	287
9.24.2.2 Messages	289
9.24.3 Process minimum reserve.....	290
9.24.4 Administrate minimum reserve penalty order.....	293
9.24.4.1 Description	293
9.24.4.2 Messages	296
9.24.5 Process minimum reserve fulfilment notification	296
9.24.5.1 Description	296
9.24.5.2 Messages	297
9.25 Information services	297
9.25.1 Send CLM query	297
9.25.1.1 Description	297
9.25.1.2 Messages	300
9.25.2 Receive CLM report	302
9.25.2.1 Description	302
9.25.2.2 Messages	303
9.25.3 Receive CLM system notification	303
9.25.3.1 Description	303
9.25.3.2 Messages	304
9.25.4 Initiate CLM operations-related broadcast	305
9.25.5 Process CLM operations-related broadcast.....	305
9.25.5.1 Description	305
9.25.5.2 Messages	306
Part III - Catalogue of messages	307

10 Messages - introduction	307
11 Messages - general information	310
11.1 Message validation.....	310
11.1.1 Structure of ISO 20022 messages	310
11.1.2 CLM-specific schema customisation	312
11.1.3 XML character set	314
11.1.3.1 Technical validation.....	315
11.1.3.2 Business validation.....	317
11.2 Communication infrastructure	318
11.2.1 Envelope messages	318
11.2.1.1 Business Application Header	318
11.2.1.2 Business File Header	319
11.2.2 Processing time information	320
11.2.3 Inbound and Outbound message size limitations	322
11.3 Usage of Messages.....	324
11.4 Message references	331
11.5 Business scenarios	334
11.6 Delta Set Retrieval Functionality	357
11.6.1 Overview.....	357
11.6.2 Initialisation of the delta set query and subsequent delta reports.....	357
11.6.3 Full scenario example for delta set query	359
12 List of messages	364
12.1 Administration (admi)	365
12.1.1 SystemEventNotification (admi.004)	365
12.1.1.1 Overview and scope of the message.....	365
12.1.1.2 Schema	365
12.1.1.3 The message in business context.....	366
12.1.2 ReportQueryRequest (admi.005)	368
12.1.2.1 Overview and scope of the message.....	368
12.1.2.2 Schema	368
12.1.2.3 The message in business context.....	369
12.1.3 ReceiptAcknowledgement (admi.007)	370
12.1.3.1 Overview and scope of the message.....	370
12.1.3.2 Schema	371
12.1.3.3 The message in business context.....	372
12.2 Cash management (camt).....	374
12.2.1 GetAccount (camt.003)	374
12.2.1.1 Overview and scope of the message.....	374
12.2.1.2 Schema	376
12.2.1.3 The message in business context.....	376
12.2.2 ReturnAccount (camt.004)	380

12.2.2.1 Overview and scope of the message	380
12.2.2.2 Schema	383
12.2.2.3 The message in business context.....	384
12.2.3 GetTransaction (camt.005)	411
12.2.3.1 Overview and scope of the message.....	411
12.2.3.2 Schema	412
12.2.3.3 The message in business context.....	414
12.2.4 ReturnTransaction (camt.006)	434
12.2.4.1 Overview and scope of the message.....	434
12.2.4.2 Schema	434
12.2.4.3 The message in business context.....	435
12.2.5 GetBusinessDayInformation (camt.018)	466
12.2.5.1 Overview and scope of the message.....	466
12.2.5.2 Schema	467
12.2.5.3 The message in business context.....	467
12.2.6 ReturnBusinessDayInformation (camt.019)	469
12.2.6.1 Overview and scope of the message.....	469
12.2.6.2 Schema	469
12.2.6.3 The message in business context.....	470
12.2.7 Receipt (camt.025)	479
12.2.7.1 Overview and scope of the message.....	479
12.2.7.2 Schema	480
12.2.7.3 The message in business context.....	481
12.2.8 GetReservation (camt.046)	492
12.2.8.1 Overview and scope of the message.....	492
12.2.8.2 Schema	493
12.2.8.3 The message in business context.....	493
12.2.9 ReturnReservation (camt.047)	495
12.2.9.1 Overview and scope of the message.....	495
12.2.9.2 Schema	495
12.2.9.3 The message in business context.....	496
12.2.10 ModifyReservation (camt.048)	499
12.2.10.1 Overview and scope of the message.....	499
12.2.10.2 Schema	500
12.2.10.3 The message in business context.....	500
12.2.11 DeleteReservation (camt.049)	502
12.2.11.1 Overview and scope of the message.....	502
12.2.11.2 Schema	503
12.2.11.3 The message in business context.....	503
12.2.12 LiquidityCreditTransfer (camt.050)	505
12.2.12.1 Overview and scope of the message.....	505
12.2.12.2 Schema	505

12.2.12.3 The message in business context.....	506
12.2.13 BankToCustomerStatement (camt.053).....	511
12.2.13.1 Overview and scope of the message.....	511
12.2.13.2 Schema	512
12.2.13.3 The message in business context.....	512
12.2.14 BankToCustomerDebitCreditNotification (camt.054)	520
12.2.14.1 Overview and scope of the message.....	520
12.2.14.2 Schema	521
12.2.14.3 The message in business context.....	521
12.3 Headers (head).....	549
12.3.1 BusinessApplicationHeader (head.001).....	549
12.3.1.1 Overview and scope of the message.....	549
12.3.1.2 Schema	550
12.3.1.3 The message in business context.....	551
12.3.2 BusinessFileHeader (head.002).....	555
12.3.2.1 Overview and scope of the message.....	555
12.3.2.2 Schema	556
12.3.2.3 The message in business context.....	557
13 List of messages specific for CBs.....	560
13.1 Cash management (camt).....	561
13.1.1 ResolutionOfInvestigation (camt.029)	561
13.1.1.1 Overview and scope of the message.....	561
13.1.1.2 Schema	561
13.1.1.3 The message in business context.....	562
13.1.2 General ledger (camt.053)	567
13.1.2.1 Overview and scope of the message.....	567
13.1.2.2 Schema	568
13.1.2.3 The message in business context.....	569
13.1.3 FIToFIPaymentCancellationRequest (camt.056).....	573
13.1.3.1 Overview and scope of the message.....	573
13.1.3.2 Schema	573
13.1.3.3 The message in business context.....	574
13.2 Credit line management (camt).....	580
13.2.1 ModifyCreditLine (camt.998) - specific for CBs.....	580
13.2.1.1 Overview and scope of the message.....	580
13.2.1.2 Schema	581
13.2.1.3 The message in business context.....	581
13.3 Minimum reserve management (camt)	584
13.3.1 AuthorizePenaltyMinimumReserve (camt.998) - specific for CBs	584
13.3.1.1 Overview and scope of the message.....	584
13.3.1.2 Schema	584

13.3.1.3 The message in business context.....	585
13.3.2 GetPenaltyMinimumReserve (camt.998) - specific for CBs.....	588
13.3.2.1 Overview and scope of the message.....	588
13.3.2.2 Schema	588
13.3.2.3 The message in business context.....	589
13.3.3 ReturnPenaltyMinimumReserve (camt.998) - specific for CBs.....	591
13.3.3.1 Overview and scope of the message.....	591
13.3.3.2 Schema	592
13.3.3.3 The message in business context.....	592
13.3.4 InsertValueOfReserveMinimumReserve (camt.998) - specific for CBs.....	600
13.3.4.1 Overview and scope of the message.....	600
13.3.4.2 Schema	600
13.3.4.3 The message in business context.....	601
13.3.5 InsertBalanceMinimumReserve (camt.998) - specific for CBs.....	604
13.3.5.1 Overview and scope of the message.....	604
13.3.5.2 Schema	604
13.3.5.3 The message in business context.....	605
13.3.6 ReturnPeriodicInformationMinimumReserve (camt.998) - specific for CBs.....	608
13.3.6.1 Overview and scope of the message.....	608
13.3.6.2 Schema	609
13.3.6.3 The message in business context.....	609
13.4 Payments clearing and settlement (pacs).....	615
13.4.1 PaymentStatusReport (pacs.002).....	615
13.4.1.1 Overview and scope of the message.....	615
13.4.1.2 Schema	615
13.4.1.3 The message in business context.....	616
13.4.2 FinancialInstitutionCreditTransfer (pacs.009).....	624
13.4.2.1 Overview and scope of the message.....	624
13.4.2.2 Schema	624
13.4.2.3 The message in business context.....	625
13.4.3 FinancialInstitutionDirectDebit (pacs.010).....	633
13.4.3.1 Overview and scope of the message.....	633
13.4.3.2 Schema	634
13.4.3.3 The message in business context.....	634
Part IV - Appendixes.....	642
14 Index and digital signature.....	643
14.1 Index of validation rules and error codes	643
14.2 Digital signature on business layer	803
14.2.1 Mechanism and introduction for signature constructions.....	803
14.2.2 Use of XML and canonicalisation algorithm	803
14.2.3 Message type 1: file with multiple ISO 20022 messages.....	803

14.2.4 Message type 2: single ISO 20022 message.....	806
------------------------------------------------------	-----

List of Figures

Figure 1 - Structure of the CLM UDFS	29
Figure 2 - A2A and U2A Connectivity	35
Figure 3 - Technical header	42
Figure 4 - BAH - inbound only	43
Figure 5 - BAH - outbound only	43
Figure 6 - Combination of service party types for CLM and RTGS	47
Figure 7 - Banking Group	66
Figure 8 - Account Monitoring Group	67
Figure 9 - Liquidity Transfer Group	68
Figure 10 - CLM business day	73
Figure 11 - T2 closing day during the week	74
Figure 12 - Currency-specific closing day during the week	74
Figure 13 - Saturday and Sunday as T2 closing days	74
Figure 14 - CLM high-level schedule with non-optional maintenance window	77
Figure 15 - CLM high-level schedule with optional maintenance window	78
Figure 16 - CLM high-level schedule on the last business day of minimum reserve maintenance period	80
Figure 17 - Settlement windows during CLM RTS with non-optional maintenance window	82
Figure 18 - Settlement windows during CLM RTS with optional maintenance window	83
Figure 19 - Standing facilities processing during EoD	87
Figure 20 - CLM cash transfer order classification	94
Figure 21 - pacs.009 sent by a CB	101
Figure 22 - pacs.010 sent by a CB	103
Figure 23 - Processing of cash transfer orders during CLM business day	117
Figure 24 - Available liquidity – on MCAs without seized amount	119
Figure 25 - Immediate liquidity transfer combinations from CLM service perspective	120
Figure 26 - Example camt.050 inter-service liquidity transfer from MCA to RTGS DCA	125
Figure 27 - Intra-service liquidity transfer order between two MCAs	127
Figure 28 - Inter-service liquidity transfer between RTGS and T2S	128
Figure 29 - Breach of floor/ceiling threshold – notification	136
Figure 30 - Breach of floor/ceiling threshold – rule-based liquidity transfer	138
Figure 31 - Excess reserve remuneration	140
Figure 32 - CLM inbound file status diagram	153

Figure 33 - CLM inbound message status diagram	154
Figure 34 - Cash transfer status diagram	155
Figure 35 - Task queue order status diagram	158
Figure 36 - Interaction between CLM and DWH	180
Figure 37 - Transactions settled in TIPS and related EoD balances	198
Figure 38 - Cross-CB turnover settlement on CB ECB accounts.....	199
Figure 39 - Settlement on ECB mirror accounts.....	200
Figure 40 - Interaction between ECONS II and CLM during a disturbance in CLM/RTGS.....	205
Figure 41 - UML conventions – example I	208
Figure 42 - UML conventions - example II.....	209
Figure 43 - Send CLM file.....	210
Figure 44 - Send CLM message.....	212
Figure 45 - Process CLM payment order and liquidity transfer order	214
Figure 46 - Perform payment order revocation	217
Figure 47 - Execute CLM standing order.....	219
Figure 48 - Settle standing order in CLM.....	221
Figure 49 - Standard CLM settlement I	225
Figure 50 - Standard CLM settlement II	230
Figure 51 - Standard CLM settlement III	233
Figure 52 - Process automated liquidity transfer order with intermediate status	236
Figure 53 - Floor and ceiling processing	238
Figure 54 - Process CLM reject time	240
Figure 55 - Initiate CLM reject time broadcast	241
Figure 56 - Process CLM reject time broadcast	242
Figure 57 - Settle connected payments.....	244
Figure 58 - Modify credit line I	248
Figure 59 - Modify credit line II	250
Figure 60 - Reject pending credit line modification	252
Figure 61 - Manage current reservation	254
Figure 62 - Reject pending reservation modification	258
Figure 63 - Reject payment order	259
Figure 64 - Process interest for accounts subject to interest calculation	261
Figure 65 - Coordinate general ledger creation with other settlement services	264

Figure 66 - Process cross-CB turnover	266
Figure 67 - Process business day event “Change of business day”	268
Figure 68 - Process business day event “Start of CLM RTS”	270
Figure 69 - Process business day event “Cut-off for CLM RTS”	271
Figure 70 - Process business day event “Start of EoD processing”	272
Figure 71 - Process “CB cut-off for standing facilities”	273
Figure 72 - Overnight deposit - refund.....	276
Figure 73 - Process automatic marginal lending – setting up	281
Figure 74 - Reimburse marginal lending	283
Figure 75 - Maintain minimum reserve requirement order	286
Figure 76 - Insert or adjust balance for minimum reserve fulfilment	288
Figure 77 - Process minimum reserve.....	290
Figure 78 - Administrate minimum reserve penalty order	294
Figure 79 - Process minimum reserve fulfilment notification	296
Figure 80 - Send CLM query	298
Figure 81 - Receive CLM report	302
Figure 82 - Receive CLM system notification.....	304
Figure 83 - Initiate CLM operations-related broadcast.....	305
Figure 84 - Process CLM operations-related broadcast.....	306
Figure 85 - XML structure, basic information.....	310
Figure 86 - XML structure, simple datatype.....	311
Figure 87 - XML structure, complex datatype.....	312
Figure 88 - Technical validation, ISO schema example	316
Figure 89 - Business validation, response example	317
Figure 90 - BAH	318
Figure 91 - BFH	320
Figure 92 - Message References	333
Figure 93 - Linking camt.056 and payment orders.....	334
Figure 94 - Message type 1, signature	804
Figure 95 - Message type 1, header.....	805
Figure 96 - Message type 1, complete example	806
Figure 97 - Message type 2, signature	808
Figure 98 - Message type 2, reference to the BAH	808

Figure 99 - Message type 2, Reference to the Message	809
Figure 100 - Message type 2, complete example	810

List of Tables

Table 1 - Combination of settlement services for non-Euro currencies	34
Table 2 - Business data and communication channels	39
Table 3 - Deduction of PTA	41
Table 4 - Set-up of parties for CLM	44
Table 5 - Service party types for CLM	46
Table 6 - Categories of accounts in CLM	53
Table 7 - Minimum reserve management at party service link level	62
Table 8 - Minimum reserve and interest calculation management at account level.....	64
Table 9 - Set-up of groups for CLM	65
Table 10 - Attributes of the CLM currency.....	69
Table 11 - Attributes of the CLM rates.....	69
Table 12 - Attributes of the reserve maintenance periods.....	70
Table 13 - Attributes of the duplicate check	70
Table 14 - Attributes of the warehoused payment period.....	71
Table 15 - Events and processes during SoD	81
Table 16 - Events and processes at the start of settlement window for CBOs	84
Table 17 - Events and processes at the start of settlement window for liquidity transfer orders	85
Table 18 - Events and processes at the “Cut-off for CLM RTS”	85
Table 19 - Events and processes after the “Cut-off for CLM RTS”	86
Table 20 - Events and processes during EoD	90
Table 21 - List of events	92
Table 22 - Cash transfer order types in CLM	95
Table 23 - CBOs in CLM.....	97
Table 24 - Payment orders with set execution time indicators.....	99
Table 25 - CB credit transfer order (technical and business validations passed)	102
Table 26 - CB direct debit order (technical and business validations passed).....	103
Table 27 - Possible modification types in CLM	105
Table 28 - Effective settlement/execution order for debits and liquidity-related tasks decreasing the available liquidity on the MCA.....	107
Table 29 - Execution of liquidity transfers.....	112
Table 30 - Entry disposition - example	113
Table 31 - Effect of changing the execution time	115

Table 32 - Effect of changing the order of queued payment orders	115
Table 33 - Origin of possible events	116
Table 34 - Liquidity transfer order types	121
Table 35 - Liquidity transfer order directions	122
Table 36 - Execution of liquidity transfers.....	123
Table 37 - Inter-service liquidity transfer from MCA to RTGS DCA	126
Table 38 - Intra-service liquidity transfer order between two MCAs.....	127
Table 39 - Inter-service liquidity transfer between RTGS and T2S	129
Table 40 - Liquidity tapping in CLM	133
Table 41 - Usage of reserve for CBOs – numeric example.....	134
Table 42 - CLM inbound file status	153
Table 43 - CLM message status.....	154
Table 44 - Cash transfer status	157
Table 45 - Task queue order status.....	161
Table 46 - Statement of accounts - report	162
Table 47 - Parameters for the set-up of a report	163
Table 48 - Initiating queries for CLM	166
Table 49 - Settlement-related broadcasts in CLM	168
Table 50 - Operations-related broadcasts in CLM	169
Table 51 - Business case description.....	175
Table 52 - Tasks of the CBs	187
Table 53 - List of account types in the respective settlement service-specific general ledger.....	196
Table 54 - List of CB specific queries	201
Table 55 - Inbound messages for Send CLM file	211
Table 56 - Outbound messages for Send CLM file	211
Table 57 - Inbound messages for Send CLM message.....	213
Table 58 - Outbound messages for Send CLM message	213
Table 59 - Inbound messages for process CLM payment order and liquidity transfer order	216
Table 60 - Outbound messages for process CLM payment order and liquidity transfer order	216
Table 61 - Inbound message for perform CLM payment order revocation	218
Table 62 - Outbound messages for perform CLM payment order revocation.....	218
Table 63 - Outbound messages for settle standing order in CLM.....	223
Table 64 - Possible results of “Attempt cash transfer order settlement”	227

Table 65 - Possible results of "Resolve queue".....	228
Table 66 - Outbound CLM settlement notifications for the CLM Account Holder or CLM CB Account Holder	232
Table 67 - Outbound CLM settlement notifications for the submitting actor	234
Table 68 - Outbound messages for process standard CLM settlement.....	235
Table 69 - Outbound message for process CLM floor or ceiling notification.....	239
Table 70 - Outbound messages for process CLM reject time broadcast.....	242
Table 71 - Outbound messages for settle connected payments.....	247
Table 72 - Inbound messages for modify credit	251
Table 73 - Outbound messages for modify credit line.....	251
Table 74 - Outbound messages for reject pending credit line modification	253
Table 75 - Inbound messages for manage current reservation	257
Table 76 - Outbound messages for manage current reservation.....	257
Table 77 - Outbound messages for reject pending reservation modification in CLM	259
Table 78 - Outbound message for reject payment order.....	260
Table 79 - Used messages to coordinate general ledger creation with other settlement services	265
Table 80 - Outbound messages for process automatic marginal lending.....	282
Table 81 - Inbound messages for maintain minimum reserve requirement.....	287
Table 82 - Outbound messages for maintain minimum reserve requirement	287
Table 83 - Inbound messages for insert or adjust balance for minimum reserve fulfilment.....	289
Table 84 - Outbound messages for insert or adjust balance for minimum reserve fulfilment.....	289
Table 85 - Inbound messages for administrate minimum reserve penalty order	296
Table 86 - Outbound messages for administrate minimum reserve penalty order	296
Table 87 - Outbound message for process minimum reserve fulfilment notification.....	297
Table 88 - A2A messages for query processing	301
Table 89 - Outbound report messages.....	303
Table 90 - Outbound message for receive CLM system notification.....	304
Table 91 - Outbound messages for process CLM operations-related broadcast.....	306
Table 92 - Supported character sets	315
Table 93 - Time information depending on the location of the business sender for winter time	321
Table 94 - Message size.....	322
Table 95 - Usage of Messages.....	331
Table 96 - Table of BICs and account identifiers	336

Table 97 - Table of business scenarios.....	356
Table 98 - Delta query cash transfer scenarios.....	359
Table 99 - Delta query business scenario query schedule.....	360
Table 100 - Delta query business scenario cash transfers	360
Table 101 - Delta query business scenario timeline.....	363
Table 102 - List of messages	365
Table 103 - SystemEventNotification (admi.004)	366
Table 104 - SystemEventNotification (admi.004) – usage case Payment reject time broadcast (Scenario 079)	367
Table 105 - SystemEventNotification (admi.004) – usage case CLM Operations Related broadcast (Scenario 080)	367
Table 106 - ReportQueryRequest (admi.005)	369
Table 107 - ReportQueryRequest (admi.005) – usage case Query Request Message - General Ledger Query (CB Only) (Scenario 066)	369
Table 108 - ReportQueryRequest (admi.005) – usage case Query Request Message - Account Statement Query (Scenario 999)	370
Table 109 - ReceiptAcknowledgement (admi.007)	372
Table 110 - ReceiptAcknowledgement (admi.007) – Message Rejection Notification (Scenario 008).....	373
Table 111 - ReceiptAcknowledgement (admi.007) – File Rejection Notification (Scenario 011).....	373
Table 112 - GetAccount (camt.003)	378
Table 113 - GetAccount (camt.003) – usage case Request for account	378
Table 114 - GetAccount (camt.003) – usage case Request for account with error response	379
Table 115 - GetAccount (camt.003) – usage case Request for minimum reserve fulfilment information by a CB, with data response.....	379
Table 116 - GetAccount (camt.003) – usage case Request for minimum reserve fulfilment information by a non-lead participant, with data response.....	380
Table 117 - ReturnAccount (camt.004)	390
Table 118 - ReturnAccount (camt.004) – usage case CLM spillover notification.....	392
Table 119 - ReturnAccount (camt.004) – usage case CLM threshold breaches - FLOR	393
Table 120 - ReturnAccount (camt.004) – usage case CLM threshold breaches - CEIL	395
Table 121 - ReturnAccount (camt.004) – usage case Request for account	405
Table 122 - ReturnAccount (camt.004) – usage case Request for account with error response	406
Table 123 - ReturnAccount (camt.004) – usage case Request for minimum reserve fulfilment information by a CB, with data response.....	409

Table 124 - ReturnAccount (camt.004) – usage case Request for minimum reserve fulfilment information by a non-lead participant, with data response.....	411
Table 125 - GetTransaction (camt.005).....	426
Table 126 - GetTransaction (camt.005) – usage case delta set query - initialisation (Scenario 077).....	427
Table 127 - GetTransaction (camt.005) – usage case delta set query – first delta query (Scenario 077)....	427
Table 128 - GetTransaction (camt.005) – usage case delta set query – second delta query (Scenario 077)	428
Table 129 - GetTransaction (camt.005) – usage case delta set query – third delta query (Scenario 077) ..	428
Table 130 - GetTransaction (camt.005) – usage case Account holder requesting all transactions (Scenario 102).....	429
Table 131 - GetTransaction (camt.005) – usage case Request for transactions with error response (Scenario 103).....	430
Table 132 - GetTransaction (camt.005) – usage case Account holder requesting a single transaction (Scenario 106)	431
Table 133 - GetTransaction (camt.005) – usage case CB requesting all transactions (Scenario 107)	432
Table 134 - GetTransaction (camt.005) – usage case CB requesting a single transaction with all fields (Scenario 108)	432
Table 135 - GetTransaction (camt.005) – usage case CB requesting marginal lending accounts (Scenario 109).....	433
Table 136 - ReturnTransaction (camt.006).....	441
Table 137 - ReturnTransaction (camt.006) – usage case delta set query - initialisation (Scenario 077)	443
Table 138 - ReturnTransaction (camt.006) – usage case delta set query – first delta query (Scenario 077).....	445
Table 139 - ReturnTransaction (camt.006) – usage case delta set query – second delta query (Scenario 077)	447
Table 140 - ReturnTransaction (camt.006) – usage case delta set query – third delta query (Scenario 077)	449
Table 141 - ReturnTransaction (camt.006) – usage case Account holder requesting all transactions (Scenario 102)	451
Table 142 - ReturnTransaction (camt.006) – usage case request for transactions with error response (Scenario 103)	452
Table 143 - ReturnTransaction (camt.006) – usage case Account holder requesting a single transaction (Scenario 106)	453
Table 144 - ReturnTransaction (camt.006) – usage case CB requesting all transactions (Scenario 107) ...	460
Table 145 - ReturnTransaction (camt.006) – usage case CB requesting a single transaction with all fields (Scenario 108)	464

Table 146 - ReturnTransaction (camt.006) – usage case CB requesting marginal lending accounts (Scenario 109).....	466
Table 147 - GetBusinessDayInformation (camt.018)	468
Table 148 - GetBusinessDayInformation (camt.018) – usage case Query Request Message - System Time Query (Scenario 057)	468
Table 149 - GetBusinessDayInformation (camt.018) – usage case Query Request Message - Event Query (Optional Maintenance Window) (Scenario 058).....	468
Table 150 - GetBusinessDayInformation (camt.018) – CLM camt.018 request for event status information (non-optional Maintenance Window) (Scenario 071)	469
Table 151 - ReturnBusinessDayInformation (camt.019)	471
Table 152 - ReturnBusinessDayInformation (camt.019) – Query Response For Business Data - System Time Query (Scenario 057)	472
Table 153 - ReturnBusinessDayInformation (camt.019) – camt.018 Request for event status information (Optional Maintenance Window) (Scenario 058).....	475
Table 154 - ReturnBusinessDayInformation (camt.019) – usage case System Notification (Scenario 059)	476
Table 155 - ReturnBusinessDayInformation (camt.019) – camt.018 request for event status information (non-optional Maintenance Window) (Scenario 071).....	479
Table 156 - Receipt (camt.025)	481
Table 157 - Receipt (camt.025) – usage case Usage Of RequestType And Status.....	482
Table 158 - Receipt (camt.025) - CLM RequestType and Status combinations	484
Table 159 - Receipt (camt.025) – usage case Current Reservation Modification Queuing Notification (Scenario 047)	485
Table 160 - Receipt (camt.025) – usage case Current Reservation Modification/Deletion Rejection Notification (Scenario 048)	485
Table 161 - Receipt (camt.025) – usage case Current Reservation Modification/Deletion Execution Notification (Scenario 049)	486
Table 162 - Receipt (camt.025) – usage case Liquidity Transfer Order Settlement Notification (Scenario 050)	486
Table 163 - Receipt (camt.025) – usage case Liquidity Transfer Order Rejection Notification (Scenario 051)	487
Table 164 - Receipt (camt.025) – usage case Credit Line Modification Execution Notification (Scenario 064)	487
Table 165 - Receipt (camt.025) – usage case Credit Line Modification Execution Notification (Scenario 065)	488
Table 166 - Receipt (camt.025) – usage case Liquidity Transfer Order Settlement Notification (Scenario 070)	488

Table 167 - Receipt (camt.025) – usage case CLM camt.998 (AutorisePenalty) is successful (Scenario 143)	489
Table 168 - Receipt (camt.025) – usage case CLM camt.998 (AutorisePenalty) fails (Scenario 144)	489
Table 169 - Receipt (camt.025) – usage case CLM camt.998 (InsertValue) is successful (Scenario 147)	490
Table 170 - Receipt (camt.025) – usage case CLM camt.998 (InsertValue) fails (Scenario 148)	491
Table 171 - Receipt (camt.025) – usage case CLM camt.998 (InsertBalance) is successful (Scenario 149)	491
Table 172 - Receipt (camt.025) – usage case CLM camt.998 (InsertBalance) fails (Scenario 150)	492
Table 173 - GetReservation (camt.046)	494
Table 174 - GetReservation (camt.046) – usage case Query Request Message - Current Reservations Query (Scenario 045)	494
Table 175 - GetReservation (camt.046) – usage case Query Request Message - Current Reservations Query (Scenario 046)	495
Table 176 - ReturnReservation (camt.047)	497
Table 177 - ReturnReservation (camt.047) – usage case Query Response For Business Data - Current Reservations Query (Scenario 045)	498
Table 178 - ReturnReservation (camt.047) – usage case Query Rejection For Failed Business Validation - Current Reservations Query (Scenario 046)	499
Table 179 - ModifyReservation (camt.048)	501
Table 180 - ModifyReservation (camt.048) – usage case Current Reservation Modification (Scenario 047)	502
Table 181 - DeleteReservation (camt.049)	504
Table 182 - DeleteReservation (camt.049) – usage case Current Reservation Deletion (Scenario 048)	504
Table 183 - DeleteReservation (camt.049) – usage case Current Reservation Deletion (Scenario 049)	505
Table 184 - LiquidityCreditTransfer (camt.050)	507
Table 185 - LiquidityCreditTransfer (camt.050) – usage case Liquidity Credit Transfer Order – MCA To MCA (Scenario 050)	508
Table 186 - LiquidityCreditTransfer (camt.050) – usage case Liquidity Credit Transfer Order – MCA To DCA (Scenario 051)	508
Table 187 - LiquidityCreditTransfer (camt.050) – usage case Liquidity credit transfer order – MCA to T2S (Scenario 052)	509
Table 188 - LiquidityCreditTransfer (camt.050) – usage case Overnight Deposit - Setting Up Order (Scenario 053)	510
Table 189 - LiquidityCreditTransfer (camt.050) – usage case Liquidity Credit Transfer Order - MCA To DCA settles (Scenario 070)	510
Table 190 - BankToCustomerStatement (camt.053)	516

Table 191 - BankToCustomerStatement (camt.053) - usage case Statement Of Account (Scenario 999)..	520
Table 192 - BankToCustomerDebitCreditNotification (camt.054)	525
Table 193 - BankToCustomerDebitCreditNotification (camt.054) – Credit Notification (Connected Payment) (Scenario 002)	527
Table 194 - BankToCustomerDebitCreditNotification (camt.054) – usage case Credit Notification (Standard CLM Settlement) (Scenario 004)	529
Table 195 - BankToCustomerDebitCreditNotification (camt.054) – usage case Credit Notification (Standard CLM Settlement) (Scenario 050)	531
Table 196 - BankToCustomerDebitCreditNotification (camt.054) – usage case Credit Line Modification Notification (Scenario 064)	533
Table 197 - BankToCustomerDebitCreditNotification (camt.054) – usage case Credit Line Modification Notification (Scenario 065)	535
Table 198 - BankToCustomerDebitCreditNotification (camt.054) – usage case Debit Notification (Standard CLM Settlement) (Scenario 068)	537
Table 199 - BankToCustomerDebitCreditNotification (camt.054) – usage case automatic marginal lending (AMLS to account holder) (Scenario 073)	539
Table 200 - BankToCustomerDebitCreditNotification (camt.054) – usage case automatic marginal lending (AMLS to CB) (Scenario 073)	541
Table 201 - BankToCustomerDebitCreditNotification (camt.054) – usage case automatic marginal lending (AMLR to account holder) (Scenario 073)	543
Table 202 - BankToCustomerDebitCreditNotification (camt.054) – usage case automatic marginal lending (AMLR to CB) (Scenario 073)	545
Table 203 - BankToCustomerDebitCreditNotification (camt.054) – usage case automatic marginal lending (MLIN to account holder) (Scenario 073)	547
Table 204 - BankToCustomerDebitCreditNotification (camt.054) – usage case automatic marginal lending (MLIN to CB) (Scenario 073)	549
Table 205 - BusinessApplicationHeader (head.001)	553
Table 206 - BusinessApplicationHeader (head.001) – usage case CLM Message – Inbound (Scenario 008)	554
Table 207 - BusinessApplicationHeader (head.001) – usage case CLM Message – Outbound (Scenario 009)	554
Table 208 - BusinessApplicationHeader (head.001) – usage case CLM Message – Inbound (Scenario 010)	555
Table 209 - BusinessFileHeader (head.002)	558
Table 210 - BusinessFileHeader (head.002) – usage case CLM File (Scenario 011)	559
Table 211 - BusinessFileHeader (head.002) – usage case CLM File (Scenario 012)	559

Table 212 - List of messages specific for CBs	561
Table 213 - ResolutionOfInvestigation (camt.029)	563
Table 214 - ResolutionOfInvestigation (camt.029) – usage case Payment Order Revocation Execution Notification (Scenario 003)	564
Table 215 - ResolutionOfInvestigation (camt.029) – usage case Revocation Rejection Notification (Scenario 004).....	566
Table 216 - ResolutionOfInvestigation (camt.029) – usage case Revocation Rejection Notification (Scenario 007).....	567
Table 217 - BankToCustomerStatement (camt.053) – general ledger	571
Table 218 - FIToFIPaymentCancellationRequest (camt.056)	576
Table 219 - FIToFIPaymentCancellationRequest (camt.056) – usage case Payment Order Revocation Request (Scenario 003).....	577
Table 220 - FIToFIPaymentCancellationRequest (camt.056) – usage case Payment Order Revocation Request (Scenario 004).....	578
Table 221 - FIToFIPaymentCancellationRequest (camt.056) – usage case Payment Order Revocation Request (Scenario 007).....	580
Table 222 - ModifyCreditLine (camt.998)	582
Table 223 - ModifyCreditLine (camt.998) – usage case Credit Line Modification (Scenario 064).....	583
Table 224 - ModifyCreditLine (camt.998) – usage case Credit line modification (Scenario 065)	583
Table 225 - AuthorizePenaltyMinimumReserve (camt.998).....	586
Table 226 - AuthorisePenaltyMinimumReserve (camt.998) – usage case camt.998 (AuthorisePenalty) is successful (scenario 143).....	587
Table 227 - AuthorisePenaltyMinimumReserve (camt.998) – usage case camt.998 (AuthorisePenalty) fails (scenario 144).....	588
Table 228 - GetPenaltyMinimumReserve (camt.998)	590
Table 229 - GetPenaltyMinimumReserve (camt.998) – usage case camt.998 (GetPenalty) query with data response (scenario 141).....	590
Table 230 - GetPenaltyMinimumReserve (camt.998) – usage case camt.998 (GetPenalty) query with error response (scenario 142).....	591
Table 231 - ReturnPenaltyMinimumReserve (camt.998)	594
Table 232 - ReturnPenaltyMinimumReserve (camt.998) – usage case camt.998 (GetPenalty) query with data response (scenario 141).....	599
Table 233 - ReturnPenaltyMinimumReserve (camt.998) – usage case camt.998 (GetPenalty) query with error response (scenario 142)	600
Table 234 - InsertValueOfReserveMinimumReserve (camt.998).....	602

Table 235 - InsertValueOfMinimumReserve (camt.998) – usage case CLM camt.998 (InsertValue) is successful (Scenario 147)	603
Table 236 - InsertValueOfMinimumReserve (camt.998) – usage case CLM camt.998 (InsertValue) fails (Scenario 148)	604
Table 237 - InsertBalanceMinimumReserve (camt.998)	606
Table 238 - InsertBalanceMinimumReserve (camt.998) – usage case CLM camt.998 (InsertValue) is successful (Scenario 149)	607
Table 239 - InsertBalanceMinimumReserve (camt.998) – usage case CLM camt.998 (InsertValue) fails (Scenario 150)	608
Table 240 - ReturnPeriodicInformationMinimumReserve (camt.998)	611
Table 241 - ReturnPeriodicInformationMinimumReserve (camt.998) – usage case CLM camt.998 (ReturnPeriodicInformation) is sent to a central bank (Scenario 151)	615
Table 242 - PaymentStatusReport (pacs.002)	617
Table 243 - PaymentStatusReport (pacs.002) – usage case Payment Order Rejection Notification (Scenario 001)	619
Table 244 - PaymentStatusReport (pacs.002) – usage case Payment Order Rejection Notification (Scenario 005)	620
Table 245 - PaymentStatusReport (pacs.002) – usage case Payment Order Settlement Notification (Connected Payment) (Scenario 002)	621
Table 246 - PaymentStatusReport (pacs.002) – usage case Payment Order Revocation Notification (Scenario 003)	622
Table 247 - PaymentStatusReport (pacs.002) – usage case Payment Order Settlement Notification (Standard CLM Settlement) (Scenario 004)	623
Table 248 - FinancialInstitutionCreditTransfer (pacs.009)	627
Table 249 - FICreditTransfer (pacs.009) – usage case Financial Institution Credit Transfer Order (Scenario 001)	628
Table 250 - FICreditTransferOrder (pacs.009) – usage case Financial Institution Credit Transfer Order (Scenario 002)	630
Table 251 - FICreditTransferOrder (pacs.009) – usage case Financial Institution Credit Transfer Order (Scenario 003)	631
Table 252 - FICreditTransferOrder (pacs.009) – usage case Financial Institution Credit Transfer Order (Scenario 004)	633
Table 253 - FinancialInstitutionDirectDebit (pacs.010)	636
Table 254 - FinancialInstitutionDirectDebit (pacs.010) – usage case Financial Institution Direct Debit Order (Scenario 005)	638
Table 255 - FinancialInstitutionDirectDebit (pacs.010) – usage case Financial Institution Direct Debit Order (Scenario 006)	639

Table 256 - FinancialInstitutionDirectDebit (pacs.010) – usage case Financial Institution Direct Debit Order (Scenario 007)	641
Table 257 - Validation rule categories	643
Table 258 - CLM business rules	802

Reader's guide

The document is structured as to guide the readers through the steps of the whole (A2A) interaction and processing details focusing on different user needs, i.e. business experts, IT experts and message experts:

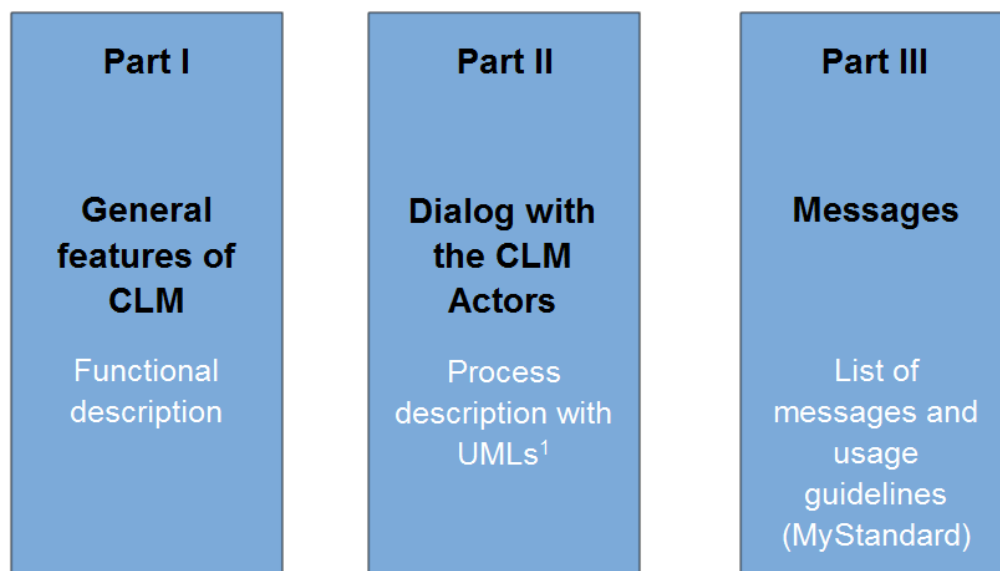

¹ UML = Unified Modelling Language

Figure 1 - Structure of the CLM UDFS

Different readers may have different needs and priorities and may not need to read the whole book.

For instance, business readers, interested mainly in organisational issues, may not wish to enter into the full details of each message description, but they might prefer going through a description of the business processes and the information flows between their own business application(s) and CLM. On the other hand, technical readers involved in the specification and development of technical interfaces to CLM may not be interested in the complete description of the features CLM offers. They would probably search the necessary information to design and build the interface of the CLM Actor's business application with CLM. The following paragraphs show - with a couple of examples - how business and technical readers may follow different reading patterns in order to fulfil their needs.

All readers, whether business or technical, are invited to read the following UDFS chapters, which are providing a minimum functional and technical background to the understanding of any other UDFS chapter:

- I [Overview of CLM](#) [▶ 32], which summarises the CLM features and functionalities;
- I [Access to CLM](#) [▶ 35], which focuses on how to connect to CLM including authentication and authorisation processes and explains the envisaged usage of access rights depending on the respective roles;
- I [Parties and accounts](#) [▶ 44], which provides a general description of the main reference data needed for CLM and the accounts maintained in CLM, specifying how they are used for the settlement of a liquidity

transfer (e.g. which CLM Actors and related accounts are involved and how to set up groups for monitoring the liquidity transfer activities).

Business oriented perspective

In addition, a business reader may be interested in the way information is structured in CLM. This user may want to follow the reading plan described below to find further details about the operations possible in CLM:

- I [Business day](#) [▶ 73], where the business reader finds an overview of respective processes and schedules;
- I [Business and features description](#) [▶ 93], which informs about the settlement process of payment orders as well as the liquidity-, reserve- and information-management;
- I [Overview of used common components in CLM](#) [▶ 176] describes the common components used by CLM and the interaction between CLM and the used common components;
- I [Process CLM payment order and liquidity transfer order](#) [▶ 213] to find a description of the processing of a payment order and useful information in order to understand the management of liquidity;
- I [Index of validation rules and error codes](#) [▶ 643] includes the relevant error codes provided in case of unsuccessful validation.

Technical oriented perspective

- I [Processes with CLM](#) [▶ 207], where an overview of the possible A2A dialogue with CLM is defined. Each sub-chapter of this chapter describes the flows within and to and from CLM. The reader can focus on the functionality of CLM, analysing the procedures and main scenarios.
- I [Part III - Catalogue of messages](#) [▶ 307], where a detailed description of the content of a given XML message is provided.

Introduction

This document describes the Central Liquidity Management (CLM) as a business component of T2 and the interactions of CLM Actors with other components and services. CLM provides information on central bank (CB) liquidity and managing credit lines and central bank operations (CBOs). In addition, CLM is the central component for funding the Real-Time Gross Settlement (RTGS), TARGET2-Securities (T2S) and TARGET Instant Payment Settlement (TIPS). The document is intended to guide CLM Actors to a proper understanding of CLM.

The User Detailed Functional Specifications (UDFS) focuses on the provision of information to CLM Actors to design and build the interface of their business application with CLM. The CLM UDFS is publicly available.

The document is divided into three parts.

- I The first part provides a full description of all the CLM features and processes, functional details concerning access to CLM and connectivity, dependencies and interactions with other services/components, operations and support features. The background information provided in chapter [Overview of CLM](#) [▶ 32] supports the understanding of CLM with its applications and the interaction with the common components described in the following chapters. Afterwards, it guides the reader through the CLM features. Moreover, it provides an overview of common components used by CLM (e.g. Common Reference Data Management (CRDM), Data Warehouse (DWH)) and a brief description of the Contingency Services. CB specific information is provided in chapter [Additional information for CBs](#) [▶ 187].
- I The second part provides process descriptions, which allow CLM Actors to interact with CLM via application-to-application (A2A). This part aims at providing a comprehensive description of all user interaction related processes being available in CLM. Moreover, the related settlement processes are explained in detail. This part guides the reader through the steps of the different scenarios – highlighting the actions undertaken by CLM and all involved CLM Actors.
- I The third part provides a detailed description of all Extensible Mark-up Language (XML) messages CLM Actors may use to interact in A2A mode with CLM. The description of the messages includes all required elements according to the schema. Wherever a message or its fields are referenced throughout the document, only the reference name is used.

Part I - General features of CLM

1 Overview of CLM

The primary aim of CLM is to offer a centralised mechanism for the steering, monitoring and management of liquidity capacity. CBOs are managed in CLM, while other credit institution's transactions with its CB are managed in RTGS. The interaction with CBs is segregated from the real-time interbank/customer payments as well as the ancillary system (AS) transactions in RTGS.

CLM offers a wide range of features to adequately provide and clearly allocate liquidity for the different settlement purposes across all Trans-European Automated Real-Time Gross Settlement Express Transfer (TARGET) Services and accounts in a given currency:

- I instruments for the management of liquidity such as immediate/standing or automated liquidity transfer orders and floor/ceiling definitions;
- I information tools, queries and reporting for the status monitoring of liquidity and processing results.

In order to reach these objectives, CLM holds main cash accounts (MCAs) as the central source of liquidity; the MCA is used for all CBOs as well as the management of the credit line (if applicable). The available liquidity can be transferred to the dedicated cash accounts (DCAs) of RTGS and T2S or TIPS Accounts. For calculating the fulfilment of the minimum reserve requirements and the automatic marginal lending facility the balances on all relevant accounts (MCAs, DCAs and TIPS Accounts) are taken into account. A CLM Account Holder is responsible for its own liquidity management and for monitoring the settlement process or grant access to another party to perform these tasks on its behalf. The A2A communication between credit institutions and all TARGET Services and common components is based on International Organization for Standardization (ISO) 20022 compliant messages.

CLM makes use of the following common components:

- I Eurosystem Single Market Infrastructure Gateway ([ESMIG](#) [▶ 182]) provides the central authentication, authorisation and user management features. It is Network Service Provider (NSP) agnostic and thus offers CLM actors the access to all TARGET Services through the connection with a single certified NSP. All NSPs comply with the same communication interface specifications in A2A mode (in store-n-forward and real-time communication protocol) and user-to-application (U2A) mode via Graphical User Interface (GUI).
- I [CRDM](#) [▶ 176] offers features that allow authorised users to set up, maintain and query all reference data that TARGET Services share for their processing activities. CRDM ensures the consistency and integrity of all reference data, processing and relationships across services/components. Furthermore, it avoids duplication of reference data or redundant implementation of the same functions in multiple services/components. Service-specific reference data objects (or functions) are set up and managed (or implemented) in the respective service/component; any change made locally is not propagated to CRDM and, if applicable, has to be made in CRDM too. The access to all collected data allows using a common Billing component as well as queries and reports.

- I [DWH](#) [▶ 177] provides the data for historical, statistical and regulatory reporting. It offers predefined queries and reports, but also the possibility to design individual reports and queries. Both modes (A2A and U2A) are available for DWH Actors. Normally, data of the previous business day shall be available in the DWH as of the start of the new calendar day at the latest.
- I The Business Day Management ([BDM](#) [▶ 183]) offers the schedule and calendar for all components and currencies. This schedule defines the structure of the business day in the T2 Service as well as the events per currency for which CLM Actors may configure standing orders and regular reports. The calendar defines the days when a T2 Service or a common component is open (and follows the defined business day schedule) or closed. Each T2 Service may have a different calendar per currency.
- I The [Billing](#) [▶ 180] component ensures the preparation and processing of invoices for CLM, RTGS and common components. To do so, relevant information for each cash account has to be defined in CRDM (e.g. to whom the invoice is addressed to, which MCA is debited, etc.) and this information is then taken into account during the Billing process. Further information on Billing and the respective fees is defined in a separate pricing guide.
- I The Legal Archiving ([LEA](#) [▶ 181]) component collects all information, which is subject to LEA requirements. The information from the T2 Service and common components is stored in LEA in its original content and format after thirty calendar days and is accessible within its retention period of ten years.
- I The [Contingency Services](#) [▶ 183] are used, in events where business continuity is impossible or systemically important payments need to be processed during the failover process. Contingency processing is a temporary means that aims at processing limited business only to avoid the creation of systemic risk.
- I The [Operational Tools](#) [▶ 185] are provided to the CB's operational staff only. Those tools have interfaces to all applications. They support the monitoring and controlling of CLM.

For the Common Components (ESMIG, CRDM, DWH, BDM and Billing) dedicated UDFS exist. The Contingency Services are described in detail in a dedicated UDFS as well.

CLM is designed to be multi-currency and to provide settlement in Euro and non-Euro central bank money.

For non-Euro settlement services, CLM must be used if RTGS is used or if both T2S and TIPS are used.

The T2 Service (CLM and RTGS) offers no currency conversion.

On the contrary, the usage of either T2S or TIPS is possible for the settlement of non-Euro currencies.

The following combinations of the various settlement services are possible for non-Euro currencies:

CLM	RTGS	T2S	TIPS
✓	✓	-	-
-	-	✓	-
-	-	-	✓

CLM	RTGS	T2S	TIPS
✓	✓	✓	-
✓	-	✓	✓
✓	✓	-	✓
✓	✓	✓	✓

Table 1 - Combination of settlement services for non-Euro currencies

2 Access to CLM

2.1 Connectivity

CLM provides access to its services through an A2A and U2A connectivity mode:

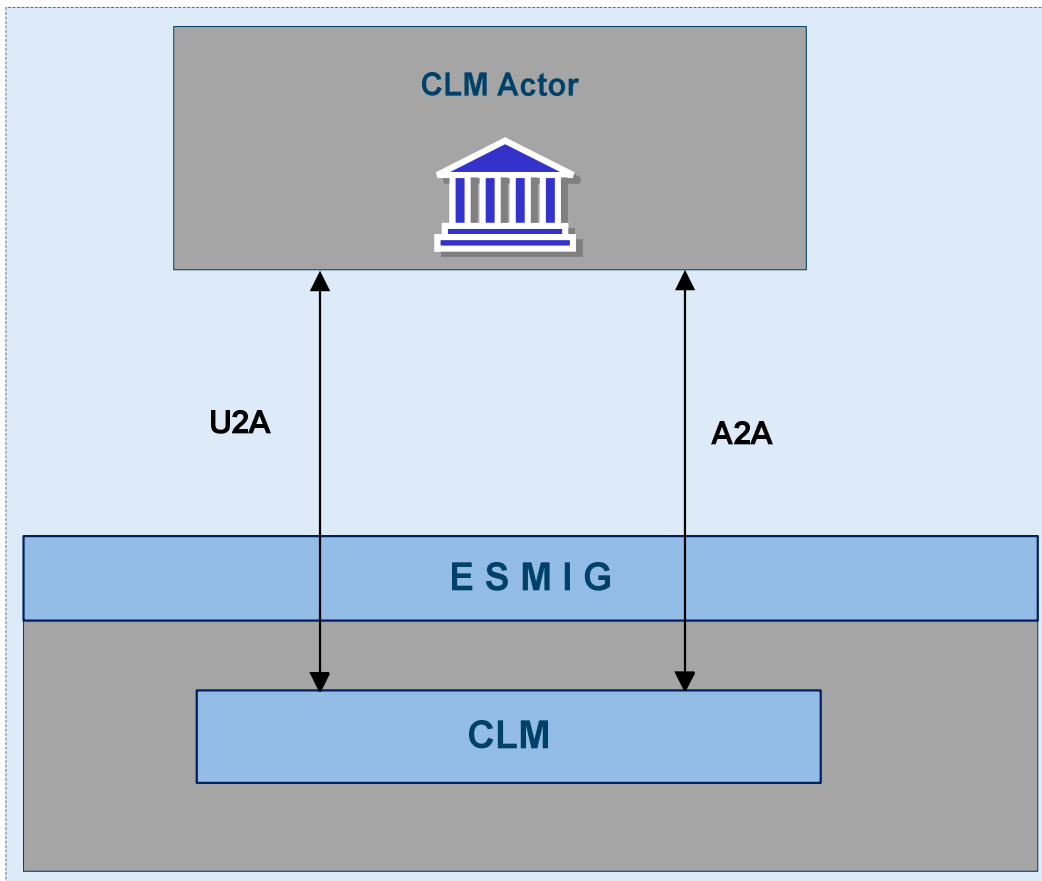

Figure 2 - A2A and U2A Connectivity

A2A connectivity

Software applications communicate with CLM by exchanging single messages and files (the latter only inbound to CLM). The A2A communication relies on XML messages, using ISO 20022 standard where applicable, for both inbound and outbound communication.

The A2A supports the following connectivity modes:

- | store-n-forward, message-based;
- | store-n-forward, file-based;
- | real-time, message-based.

The chapter [Communication between CLM and CLM Actors](#) [▶ 38] provides further details.

The store-n-forward connectivity mode provides for the sending messages even when the receiver is not reachable in the moment of the message sending. The store-n-forward connectivity mode employs a retry mechanism to resend the message until successful delivery is employed. Real-time communication requires the sender and the receiver of the communication to be available and reachable when the message is sent. No retry mechanism is available for the real-time mode when the message cannot be delivered.

The A2A connectivity mode supports a message-based and a file-based transmission channel. The use of a connectivity channel is dependent on the size of business content that is to be transmitted. The limit for a message-based communication is 32 KB, while the maximum size of a file-based communication is limited to 32 MB. Therefore, the transmission channel is not dependent on the type of communication, i.e. file or message, (introduced respectively by a BFH or BAH), but on the size of the communication. Individual messages can be sent using file-based communication (and must be if they exceed the size limit of message-based transmission) and files can be sent using message-based communication when the size limit is not exceeded.

U2A connectivity

CLM Actors can access defined functionalities in CLM through its dedicated GUI.

Contingency Upload of A2A files and messages in U2A

This is a mixture of both connectivity options since a precondition is U2A access to a dedicated GUI screen which then enables a CB to upload A2A files and messages.

More details are provided in chapter [Contingency upload of A2A files and messages in U2A](#) [▶ 205].

2.2 Authentication and authorisation process in CLM

A Distinguished Name (DN) identifies an individual or application interacting with CLM. A DN is a sequence of attribute-value assertions separated by commas, e.g. <cn=meier,ou=clm,o=bnkacct,o=nsp-nspname>.

DNs are uniquely linked to digital certificates, which CLM Actors assign to their users, i.e. individuals interacting with CLM in U2A mode or applications interacting with CLM in A2A mode.

ESMIG authenticates the CLM Actor and carries out an authorisation check at service level in order to verify whether the DN is permitted to submit requests to CLM. The ESMIG UDFS, chapter "*Technical message validation*" contains exhaustive information on all the authentication and authorisation checks ESMIG performs. If these checks are successful, then ESMIG forwards the request and the sender's DN to CLM.

CLM then carries out the authorisation of the sender at application level. The DN that is used to sign the A2A message is linked to at least one user or application since it is possible to use one DN by more than one user. The user may have one or many roles. The authorisation of the request is checked against the role's access privileges. The privileges, which are used in CLM, are listed in the CRDM UDFS, chapter "*Privilege*"

in the table "CLM functions" and in the CLM UHB (chapter "List of privileges") Privileges listed in the CRDM UDFS as "A2A only" or "U2A only" are marked accordingly.

2.3 Security

This chapter describes the main principles to ensure the security of CLM.

It means that the following security criteria are met:

- I **confidentiality**: ensuring that information is accessible only to authenticated and authorised CLM Actors;
- I **integrity**: safeguarding the accuracy, completeness and authenticity of information;
- I **availability**: ensuring that authorised users have access to information and associated assets in the correct format when required;

2.3.1 Confidentiality

The confidentiality of data is ensured by the possibility to grant specific access rights for any given set of data. The granting of specific access rights in conjunction with authentication and authorisation mechanisms ensures that each CLM Actor's data is treated confidentially and is not accessible to unauthorised actors when CLM processes A2A and U2A requests.

2.3.2 Integrity

Within CLM, various business validations ensure the integrity of information. If a business validation fails, CLM has a concept of error handling in place. The requested action is not processed and CLM provides the user with detailed information regarding the nature of the error.

In U2A mode, CLM offers users in addition the possibility to further ensure the data integrity via usage of a dual authorisation concept, the four-eyes principle. In case this option is chosen for a specified set of CLM operations, a second independent verification and confirmation is required before an operation can be executed in CLM.

Furthermore an audit trail provides the possibility to query through U2A interface for A2A entries and U2A tasks or by a user defined DWH report the modified data at the attribute level, the user performing the change and the timestamp of the change made. This audit trail shows both the changed attributes and the new values.

2.3.3 Availability

The overall availability of CLM is ensured by the infrastructure design and a centralised technical architecture. This, together with a high level of inherent infrastructure redundancy and dedicated IT resources ensure the maximum availability for CLM.

Availability is also ensured by operational, security-operational and technical monitoring. CLM operational monitoring provides tools to the operator for the real-time detection of functional and operational and security problems. Technical monitoring allows for the detection of hardware and software problems via real-time monitoring of the technical components involved in the processing, including the network connections.

2.4 Graphical User Interface

The CLM GUI allows users to perform business functions based on their respective access rights. It allows users to enter and maintain business data as well as to retrieve business information.

The CLM User Handbook (UHB) provides exhaustive information on each of the business functions that the CLM GUI provides.

2.5 Communication between CLM and CLM Actors

This chapter aims to introduce the interactions in A2A mode and how they should be used for communication between CLM actors' back-end applications and CLM.

It starts with a categorisation of the different communication channels and their related network services. In that context the usage of technical and business data is depicted.

In general, the communication on business and technical level is in general identical, i.e. if a message should be sent to CLM the message has to be addressed on both levels to CLM. The only difference is the kind of data used for addressing the message. In the technical transport header a PTA based on DN is used whereas the addressing on business level is based on BICs (Business Identifier Code). The differences will be illustrated briefly in the last section of this chapter.

Communication channels can be categorised as follows:

- | store-n-forward;
- | real-time.

With the distinction of message-based and file-based network services this allows three network service types:

- | store-n-forward message-based network service;
- | store-n-forward file-based network service;

- | real-time message-based network service¹.

The communication channel is part of the PTA that represents the core element for the routing of messages. The communication channel depends on the type of exchanged business data which can be categorised as follows.

- | **Instructions** are messages that intend to create or change data in CLM. External actors can only send instructions to CLM in store-n-forward mode.
- | **Queries** are messages that intend to retrieve data from CLM. Queries are only sent using real-time mode.
- | **Reports** are messages that intend to provide data in push mode from CLM in store-n-forward mode.

Note: The pull functionality for reports is reflected in query description via an account statement query, i.e. [Query management for CLM](#) [▶ 164].

- | **Notifications** are messages that intend to provide status information in push mode from CLM. Notifications are provided in store-n-forward mode in result of an instruction.

The following table summarises how the main types of CLM business data exchanges are mapped against the technical features of the different network services for inbound and outbound communication including files:

CLM business data exchanges	Inbound communication request	Outbound communication response
Instructions	Store-n-forward message-based, store-n-forward file-based	Store-n-forward message-based, store-n-forward file-based
Queries	Real-time message-based	Real-time message-based in case of timeout and/or oversize store-n-forward message-based or store-n-forward file-based (see chapter Inbound and Outbound message size limitations [▶ 322]) ²
Reports	N/A	Store-n-forward message-based, store-n-forward file-based
Notifications	N/A	Store-n-forward message-based, store-n-forward file-based

Table 2 - Business data and communication channels

¹ Real-time file-based network service is not supported.

² Timeout handling and the switch from store-n-forward message-based to store-n-forward file-based is handled in ESMIG. Respective details are provided in the ESMIG UDFS, chapter "*Timeout and oversized management*".

A PTA consists of three items:

1. a technical receiver name which is represented by a DN;
2. an NSP;
3. a channel.

Possible values for a channel are:

- | store-n-forward message-based;
- | store-n-forward file-based;
- | real-time message-based.

The PTA for a message sent by CLM is derived as follows:

CLM business data exchanges	Communication channel	Deduction of PTA
Notification as response to an instruction	Store-n-forward message-based, store-n-forward file-based	A notification as response to an instruction is sent to the same network service and PTA which were used for sending the related inbound communication.
Notifications being not a response to an instruction but belonging to a business case triggered by an instruction, e.g. BankToCustomerDebitCreditNotification (camt.054) [520]	Store-n-forward message-based	The store-n-forward notification being not a response to an instruction is sent to the PTA that is defined in the routing configuration.

CLM business data exchanges	Communication channel	Deduction of PTA
Revocation of payment orders and rejection of cash transfer orders	Store-n-forward message-based, store-n-forward file-based	Revocation of payment orders and rejection of cash transfer orders are sent to the PTA which is derived from the addressed business receiver (identified in the attribute <To> BIC located in the BAH of the message)
Responses to queries	Real-time message-based, timeout, store-n-forward message-based, store-n-forward file-based	Responses to real-time messages are sent to the PTA of the sender of the query. In case of timeout and/or oversize additional messages are sent using the store-n-forward message-based network channel or store-n-forward file-based network channel for the same technical receiver and the same network provider. ³
Reports	Store-n-forward file-based, store-n-forward message-based	Reports are sent in store-n-forward mode to the PTA that is defined in the routing configuration.

Table 3 - Deduction of PTA

Note: In case of other actors without a routing configuration it is not possible to send "notifications not being a response to an instruction" and reports. Such actors need to be treated as U2A only actors in CLM.

For further information see the CRDM UDFS, chapter "*Party data management*".

Connectivity requirements for CLM actors

Store-n-forward mode:

- I Each external actor sending store-n-forward traffic to CLM has to be able to receive store-n-forward traffic with the sender DN and NSP for message-based and file-based network channel.
- I According to the routing configuration the technical receiver name and the NSP are defined for receiving store-n-forward traffic from CLM. The external actor has to support message-based and file-based network channel.

Real-time mode:

³ Timeout handling and the switch from store-n-forward message-based to store-n-forward file-based is handled in ESMIG. Respective details are provided in the ESMIG UDFS, chapter "*Timeout and oversized management*".

- each external actor sending real-time traffic to CLM has to be able to receive real-time and store-n-forward traffic with the sender DN and NSP for message-based and file-based network channel (the latter for store-n-forward only).

Link routing information on technical and business level

The PTA is always set-up as “point-to-point” information, i.e. if a message is sent by a party A to CLM the PTA of party A is represented by the related DN on technical transport layer of the message and the PTA of CLM is also identified by a DN. Further details on the set-up are provided in the ESMIG UDFS, chapter "Authentication and authorisation concepts".

On the business layer, represented by the BAH, the identification of the relevant CLM actor as well as CLM itself is based on BICs.

For each inbound message it will be checked if the DN used in the technical transport header is linked to the BIC used in the From section of the BAH.

For notifications as responses to instructions and responses to queries, no routing configuration in CRDM is needed as the notifications are always returned to the technical sender of the initial inbound message.

A CRDM routing configuration applies to notifications not being a response to an instruction and to reports:

- for such notifications only the default routing configuration of the respective account holder/party in CRDM applies;
- for reports [camt.053](#) [▶ 511] each report receiving party can define exactly one PTA deviating from the default routing the message shall be send to.

CLM identifies the channel (store-n-forward message-based or store-n-forward file-based) depending on the size of the message to be sent and the system limitation.

Addressing of messages on business level when sent to CLM

Messages which can be sent by CLM Actors to CLM are instructions and queries.

In contrary to RTGS in all messages sent to CLM the CLM BIC must be used in BAH section <To>. In consequence, a directory listing all the addressees comparable to the RTGS Directory is not necessary in CLM.

Simplified illustration addressing of messages for inbound and outbound communication on technical transport header level:

Technical header inbound:

Sender: DN CLM Actor A
Receiver: DN CLM

Technical header outbound:

Sender: DN CLM
Receiver: DN CLM Actor A

Figure 3 - Technical header

Simplified illustration addressing of instructions for inbound communication on business level if sent by a CB Account Holder:

BAH inbound:
From: Party BIC CB A
To: BIC CLM

Figure 4 - BAH - inbound only

Simplified illustration addressing of notifications on instructions for outbound communication on business level sent by CLM:

BAH outbound:
From: BIC CLM
To: Party BIC CB A

Figure 5 - BAH - outbound only

3 Parties and accounts

3.1 Parties

The CLM participation model envisions different types of CLM Actors, with different roles and responsibilities, as outlined in chapter [Concept of party in CLM](#) [▶ 45].

This chapter provides a description of the objects CRDM stores and CLM uses for its CLM Actors. Moreover it focuses in particular on the reference data in the context of parties used in CLM. In [Overview of used common components in CLM](#) [▶ 176] the main focus is on CRDM features: set-up of objects, the access rights concept and CRDM specific reference data.

More in detail, chapter [Set-up of parties](#) [▶ 44] identifies the reference data related to the set-up of CLM Actors and it provides detailed information on who is responsible for the set-up of these reference data. Chapter [Concept of party in CLM](#) [▶ 45] defines the concept of party in CRDM and the way this concept relates with the different types of legal entities that can interact with CLM. In addition, this chapter mentions the so-called hierarchical party model, i.e. the organisational structure of parties in CRDM. The chapter [CLM - specific party service link](#) [▶ 46] defines, based on the party type, service party types, which ensure the correct link to business functionalities. The chapter [Reference data for parties used by CLM](#) [▶ 47] illustrates the reference data required by CLM for each party.

3.1.1 Set-up of parties

A party is defined as a legal entity or organisation interacting with CLM. The set-up of parties for CLM takes place in CRDM.

The operator is responsible for setting up and maintaining party reference data for all CBs relevant for CLM. CBs are responsible for setting up and maintaining party reference data for the parties of their community.

The following table summarises the configuration responsibilities for each reference data object related to parties in CLM and specifies the required communication mode:

Reference data object	Responsible actor	Mode
Party (CB)	Operator	A2A/U2A
Party (payment bank)	CB	A2A/U2A
Party (AS)	CB	A2A/U2A

Table 4 - Set-up of parties for CLM

3.1.2 Concept of party in CLM

The party model of CLM is based on a hierarchical three-level structure. The operator is the only party at the first level of the hierarchy and is responsible for the set-up of each party of the second level, i.e. each CB in CLM. In case a CB wants to offer settlement in multiple currencies, the existence of one system entity of this CB per currency is required.

Similarly, each CB belonging to the second level is responsible for the set-up of all parties of its community, represented by parties of the third level. In CLM, payment banks belong to the third hierarchy level. In case a CB offers settlement in multiple currencies and a payment bank wants to settle in these currencies, it is required for a payment bank to open a party⁴ per currency.

As every party is identified by a unique BIC 11, it needs to be ensured during the set-up of reference data that the party BIC used in one of the TARGET settlement services is unique. In case it is not possible in very specific circumstances to ensure that a party BIC11 is unique across all TARGET settlement services, CLM will not load the party data and all its reference data into its local data model.

This means that each CB is responsible for the reference data of its community. Further information about the hierarchical model can be found in the CRDM UDFS, chapter “*Common reference data objects and hierarchical party model*”. Information about the data scope is included in chapter “*Data scope*”.

Each party belongs to (only) one of the following party types according to the above-mentioned hierarchical party model:

- | operator;
- | CB;
- | payment bank;
- | AS.

Note: The party type defines the level within the hierarchy in the CRDM reference data.

The **operator** is the organisational entity that is responsible for operating CLM. It is responsible for the initial set-up and day-to-day operations of CLM and acts as single point of contact for CBs in case of technical issues. It is monitoring the system and carrying out corrective actions in case of incidents or in case of service/component unavailability. The operator is also responsible for setting up and maintaining the reference data of the CBs in CRDM. Upon request of the respective CB, the operator may use CLM functions on behalf of any CLM Actor. It has full access to all live reference data and transactional data in CLM.

CBs are responsible for setting up and maintaining reference data in CRDM for all CLM Actors belonging to their community. CBs can also act as CLM Account Holders themselves. In addition, they can act on behalf of any of their parties on the third level in case of need. CBs may instruct a payment debiting any CLM Account in its books, or for which it has a direct debit mandate, and crediting any account in CLM.

⁴ Each party has to be identified with a valid and unique BIC11.

Payment banks represent CLM Actors that own MCAs. Payment banks are responsible for their own liquidity management and have to make sure that sufficient liquidity is available in the different settlement services that they use. They are responsible for instructing liquidity transfers and monitoring the liquidity usage. However, the set-up and maintenance of the MCAs is done by CBs upon request of the respective payment bank.

Ancillary system represent CLM Actors that own MCAs. Ancillary systems may use their accounts for liquidity purposes (potentially incl. credit line) and the payment of interest; there is no AS business taking place in CLM.

3.1.3 CLM - specific party service link

The party service link is used to link a party to a service or component.⁵ This means it defines the participation of a party type in a specific service or component.

In addition to the party type, a party is also identified by a service party type (an attribute of the party service link), which defines the business function a party may use. In CLM, each party requires at least one service party type.

The following service party types exist for CLM:

Party type	Possible service party types for CLM
CB	CLM CB Account Holder CLM Transit Account Holder CLM CB Technical Account Holder
Payment bank	CLM Account Holder Institution managing minimum reserve without account in CLM
Ancillary system	CLM Account Holder

Table 5 - Service party types for CLM

During the creation of a CLM Account Holder, a flag allows CBs to identify that the account holder uses the component U2A-only. These U2A-only CLM Account Holders are not allowed to set-up report configuration in push mode, message subscription and routing configuration.

The service party types “CLM Account Holder” and “Institution managing minimum reserve without account in CLM” are mutually exclusive.

⁵ i.e. a party is set-up only once in CRDM and can be linked to several services or components.

The service party type “CLM Transit Account Holder” is required for the set-up of the CLM dedicated transit accounts whereas the service party type “CLM CB Technical Account Holder” is required for the set-up of the CB European Central Bank (ECB) accounts and the ECB mirror accounts.

Note: This table describes only the service party types for CLM. It is possible for a party to combine service party types for CLM with service party types for other services/components: e.g. a Payment bank can simultaneously act as CLM Account Holder (through the party service link CLM) and RTGS Account Holder (through the party service link RTGS), as illustrated in the following graph:

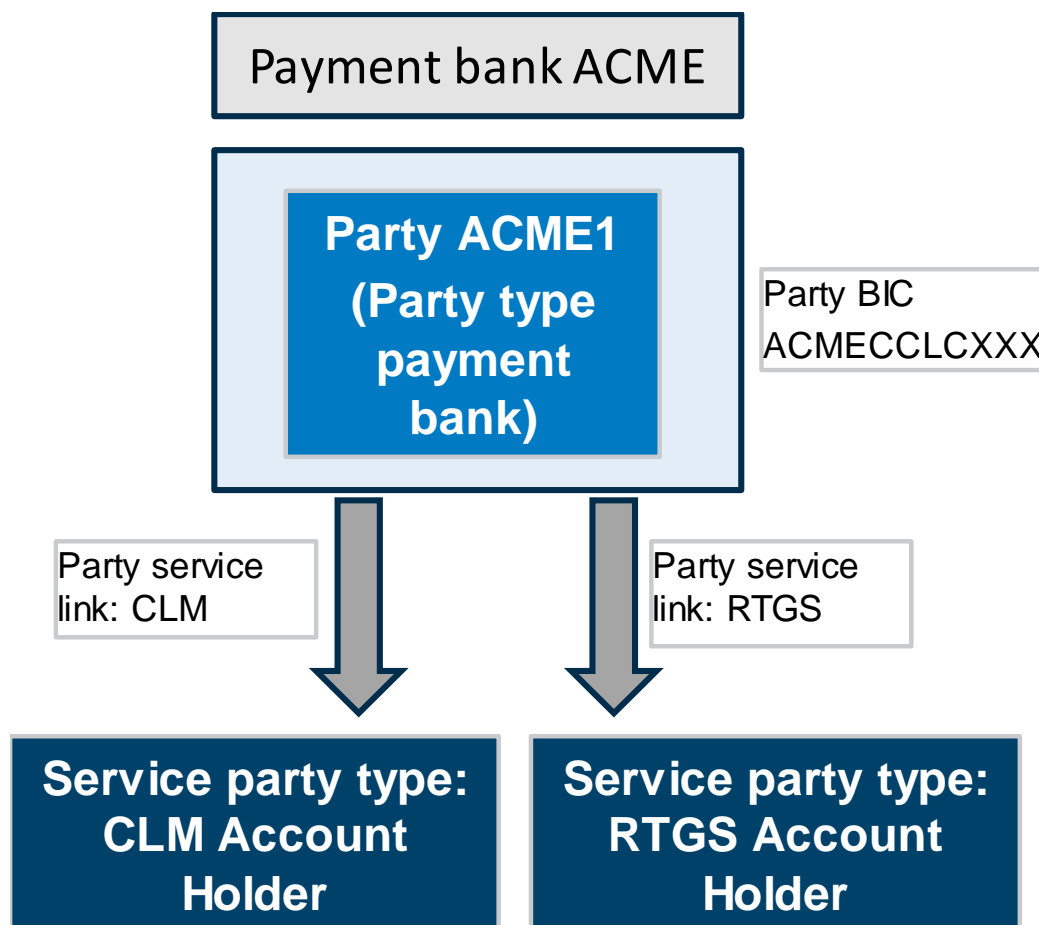

Figure 6 - Combination of service party types for CLM and RTGS

3.1.4 Reference data for parties used by CLM

This chapter is related to the corresponding chapter in the CRDM UDFS. For further details see CRDM UDFS chapter “Description of the entities > Cash account”.

3.1.5 Blocking/unblocking party

The blocking/unblocking of a party is possible. Blocking is done by the responsible CB.

Consequently, the affected party (with party type payment bank or ancillary system) is blocked in CLM and in RTGS, depending on the settlement services the party is linked to. The blocking is under the full responsibility of the respective CB. The CB initiates the blocking at party level (as a restriction type) via the CRDM GUI.

When blocking a party in CRDM the blocking request includes a valid from date. If the valid from date is specified as the current business date, the blocking becomes effective immediately in all T2 settlement services the party is linked to. The same behaviour is applicable for the unblocking of parties regarding the valid to date. When unblocking a party for a future business date, the valid to date is considered as excluded, i.e. the party is unblocked on the specified valid to date.

As soon as a party is blocked at party level, all cash accounts belonging to that party in CLM are blocked too. However, the blocking of a payment bank on party level does not automatically block the standing facilities accounts dedicated to this party. This has to be done separately. Further information on account blocking is provided in chapter [Blocking/unblocking account](#) [▶ 60].

3.2 Accounts structure and functionalities

Accounts are opened in CLM for the provision of liquidity and the settlement of CBOs.

This chapter provides a detailed description of the reference data CRDM stores and CLM uses for all its accounts.

The following categories of accounts can be set up and maintained in CRDM for CLM:

- | MCAs;
- | CLM dedicated transit accounts;
- | CLM CB accounts;
- | overnight deposit accounts;
- | marginal lending accounts;⁶
- | CB ECB accounts;
- | ECB mirror accounts;
- | CLM technical account for ECONS II.

Once an MCA is set up by the CB, CLM Account Holders can set up the following functionalities on their MCA:

- | floor/ceiling;
- | standing order liquidity transfer order;
- | standing order for reservation;

⁶ Not used anymore after launch of ECMS.

- | current reservation;
- | message subscription;
- | report configuration;
- | routing configuration.

The set-up and maintenance of the direct debit mandate and the co-management is done by the responsible CBs.

The following chapters describe the above-mentioned reference data objects.

3.2.1 Account types

This chapter gives an overview of all account types used in CLM. Each account has to be linked to a party.

MCA

An MCA is an account used for the settlement of CBOs and liquidity transfers, as well as the management of the credit line. The sum of the account balance of the MCA plus the credit line thereto must not be negative. In case CLM does not receive any information whether an account is credit-based in the data propagated by CRDM, CLM will apply as default value « credit-based = true ».

An MCA is identified by a BIC11 (which must be unique in CLM per currency) and by an account number (which must be unique across all settlement services).

Settlement in a given CLM currency is possible only if the MCA on which the settlement takes place is denominated in this currency.

The condition to set up an "MCA" is to have a party of party type "payment bank" or "AS". Moreover, the service party type "CLM Account Holder" must be linked to the party. Therefore, if the account holder of the MCA is a CB, it has to create a party for itself at the third level of the hierarchical model (i.e. payment bank).

CRDM creates a CLM Repository each business day (at 17:00) in order to provide routing information for central banks. More details can be found in the CRDM UDFS, chapter "*CLM Repository*".

Any CLM Account Holder must always have an MCA. When defining one or many MCA(s) for the same party, one must be marked as default. The default link is important for the minimum reserve calculation ([Static data configuration for minimum reserve management and interest calculation](#) [▶ 61]). In addition, the credit line, if granted, is assigned to this default MCA.

The default MCA is the only account on which the following operations are processed:

- | update of credit line;
- | reimbursements linked marginal lending and overnight deposits (summarised as standing facilities);
- | monetary policy operations other than standing facilities (e.g. open market operations like the main refinancing operation or the longer-term refinancing operations);

- | interest payment orders linked to marginal lending, overnight deposits, minimum reserves and excess reserves;
- | infringement penalties regarding monetary policy instruments (e.g. minimum reserves);
- | any other activity carried out by CBs in their capacity as CB of issue.

Note: In case no default MCA is defined for the Leading CLM Account Holder, CLM checks whether any other MCA exists for the Leading CLM Account Holder in order to settle interests and penalties.

The following operations are processed on any MCA:

- | cash withdrawals and cash lodgements;
- | liquidity transfers;
- | debit of the invoiced amount (MCA as defined in CRDM).

In order to fulfil minimum reserve obligations directly, an MCA needs to be opened.

Each MCA may be part of one or many Liquidity Transfer Groups; may belong to one or many Account Monitoring Groups and via the respective party to one Banking Group ([Types of groups](#) [▶ 65]).

It is up to CBs to set up and maintain MCAs for their CLM Account Holders.

A party holding at least one MCA and at least one RTGS DCA can establish a one to one link (through the Associated Liquidity Transfer Account attribute) between its MCA and one of its RTGS DCAs. This link is the condition for automated liquidity transfers and one precondition for rule-based liquidity transfers due to queued payment orders or AS transfer orders. It is up to the CLM Account Holders to decide which RTGS DCA should be the linked one. The CBs are in charge of the set-up and maintenance.

CLM dedicated transit account

CLM dedicated transit accounts are accounts owned by CBs. They shall either have a zero or a positive balance as they reflect any movement of liquidity from/to the various settlement services (i.e. RTGS, T2S and TIPS). In case CLM does not receive any information whether an account is credit-based in the data propagated by CRDM, CLM will apply as default value « credit-based = false ». They are technical accounts involved in the inter-service liquidity transfer process between CLM and the other services and cannot be involved in the settlement of CBOs. The CLM dedicated transit accounts cannot be directly addressed by the CLM Account Holder in a liquidity transfer.

The condition to set up a “CLM dedicated transit account” is to have a party of party type “CB”. Moreover, the service party type “CLM Transit Account Holder” must be linked to the party.

Each CLM dedicated transit account related to one service is linked to one and only one CB.

There is only one CLM dedicated transit account per settlement service/settlement currency combination in CLM. The CLM dedicated transit accounts for Euro belong to the ECB. The account types of the different CLM dedicated transit accounts are the following:

- | CLM dedicated transit account for T2S;

- | CLM dedicated transit account for TIPS;
- | CLM dedicated transit account for RTGS.

The operator creates the dedicated transit accounts.

CLM CB Account

A CB Account in CLM is a cash account that is owned by a CB and that is allowed to have a negative balance. It cannot be restricted or limited in its use. In case CLM does not receive any information whether an account is credit-based in the data propagated by CRDM, CLM will apply as default value

- | for a CLM CB Accounts owned by an out-CB « credit-based = true » and
- | for a CLM CB Account owned by an Eurosystem CB « credit-based = false ».

The condition to set up a “CLM CB account” is to have a party of party type “CB”. Moreover, the service party type “CLM CB Account Holder” must be linked to the party. The purpose of the account is to provide liquidity and to withdraw liquidity due to CBOs.

A CLM CB Account is identified by a BIC¹⁷ (that must be unique in CLM per currency) and by an account number (that must be unique across all settlement services).

CBs may open multiple CLM CB accounts, e.g. to dedicate them for standing facility interests, minimum reserve interests and penalties or other interests. There are no restrictions for additional CLM CB accounts. When opening many CLM CB accounts for one central bank, one has to be marked as default. The default CLM CB Account is used for the following cases:

- | In case of closure of accounts the remaining or missing liquidity for the account to be closed is transferred by an emergency liquidity transfer to/from the default CLM CB Account (see chapter [Closing of accounts still containing a balance](#) [▶ 61]).
- | All interest payments related to overnight deposit and marginal lending⁸ are processed via this account (if no specific account is configured).
- | All interest and penalty payments related to minimum reserve management are processed via this account (if no specific account is configured).
- | For other interests (if no specific account is configured).
- | After the go-live of ECMS it is also foreseen to process all automatic marginal lending payments via this account.

Overnight deposit account

An overnight deposit account is owned by the relevant CB but is opened in the name of the CLM Account Holder. This is done via the attribute “linked account” and therefore it is possible for the CLM Account Holder

⁷ The account BIC is stored in the authorised account user.

⁸ Until launch of ECMS.

to set up and reverse overnight deposits and to see the balance on the respective overnight deposit account. In case CLM does not receive any information whether an account is credit-based in the data propagated by CRDM, CLM will apply as default value « credit-based = true ».

The condition to set up an “Overnight deposit account” is to have a party of party type “CB”. Moreover, the service party type “CLM CB Account Holder” must be linked to the party.

There is one overnight deposit account for each CLM Account Holder having access to standing facilities.

An overnight deposit account in CLM is identified by a unique account number (that must be unique across all settlement services) but not by a dedicated account BIC.

It is up to the CBs to set up and maintain the overnight deposit accounts.

Marginal lending account

A marginal lending account is owned by the relevant CB but is opened in the name of the CLM Account Holder. This is done via the attribute “linked account” and therefore it is possible for the CLM Account Holder to see the balance on the respective marginal lending account. In case CLM does not receive any information whether an account is credit-based in the data propagated by CRDM, CLM will apply as default value « credit-based = false ».

The condition to set up a “Marginal lending account” is to have a party of party type “CB”. Moreover the service party type “CLM CB Account Holder” must be linked to the party. There is one marginal lending account for each CLM Account Holder subject to standing facilities.

A marginal lending account in CLM is identified by a unique account number (that must be unique across all settlement services) but not by a dedicated account BIC.

It is up to the CBs to set up and maintain the marginal lending accounts.⁹

CB ECB account

A CB ECB account is an account that records the CB’s asset/liability position towards the ECB in respect of cross-CB community transactions. In case CLM does not receive any information whether an account is credit-based in the data propagated by CRDM, CLM will apply as default value « credit-based = false ».

Note: If two CLM Account Holders from different countries have an account with the same CB, then a transaction between these two accounts (which is cross-border) is not reflected in the CB ECB accounts.

The account is owned by the relevant CB and is identified by a unique BIC11.

The condition to set up a “CB ECB account” is to have a party of party type “CB”. Moreover the service party type “CLM CB Technical Account Holder” must be linked to the party.

⁹ After the go-live of ECMS marginal lending accounts are not used anymore.

ECB mirror account

An ECB mirror account is an account owned by the ECB for each CB on which the settlement postings done on the CB ECB accounts are “mirrored”. In case CLM does not receive any information whether an account is credit-based in the data propagated by CRDM, CLM will apply as default value « credit-based = false ». The link to the respective CB is done via the attribute “linked account”. The account is owned by the ECB and is identified by a unique BIC11.

The condition to set up an “ECB mirror account” is to have a party of party type “CB”. Moreover, the service party type “CLM CB Technical Account Holder” must be linked to the party.

CLM technical account for ECONS II:

The CLM technical account for ECONS is set up in CRDM. It is needed for the settlement of balances from ECONS II in CLM on the ECONS II closing date. In case CLM does not receive any information whether an account is credit-based in the data propagated by CRDM, CLM will apply as default value « credit-based = false ».

The following table summarises the categories of accounts in CLM and the related service party types for each account type:

	CLM Account Holder	CLM CB Account Holder	CLM Transit Account Holder	CLM CB Technical Account Holder	Institution managing minimum reserve without account in CLM
MCA	X				
CLM dedicated transit accounts			X		
CLM CB Account		X			
Overnight deposit account		X			
Marginal lending account ¹⁰		X			
CB ECB account				X	
ECB mirror account				X	

Table 6 - Categories of accounts in CLM

10 Only used until the go-live of ECMS

3.2.2 Reference data for accounts used by CLM

This chapter is related to the corresponding chapter in the CRDM UDFS. For further details see CRDM UDFS chapter "*Description of the entities > Cash Account*".

3.2.3 Functionalities

This chapter describes the functionalities available at MCA level.

Direct debit mandate

The direct debit functionality in CLM can only be used by CLM CB Account Holders, as payment banks are not allowed to send payments in CLM.

A CB¹¹ can send direct debit orders to the MCAs opened in its books in CLM without prior definition of a direct debit mandate. The direct debit mandate is a prerequisite for a CB for instructing direct debits if the direct debit order shall debit the MCA in CLM which is not opened in its books (i.e. an MCA belonging to a CLM Account Holder of another CB).

The CLM Account Holder shall instruct its CB to set up and maintain the direct debit mandate in CRDM.

The direct debit facility can be used in CLM by CBs in case of:

- | settlement of cash withdrawals;
- | settlement of monetary policy operations (e.g. repayment of liquidity providing operations, initial settlement of liquidity absorbing operations);
- | collections of fees;
- | debiting interest, infringement penalties, etc.

All actions (set up, modify, delete) become effective as of the next business day or on the activation date of the MCA if this is later than the next business day.

A list of direct debit mandate reference data attributes can be found in the CRDM UDFS, chapter "*Description of entities > Direct Debit Mandate*".

It is up to CBs to set up and maintain the direct debit mandate(s) of CLM Account Holders in CRDM, based on information submitted to them by the CLM Account Holder.

Note: In addition to the direct debit mandate itself also the maximum amount for direct debits defined at account level is of relevance. For amount fields which are available in the direct debit mandate as well as for the maximum amount for direct debits defined at account level CRDM propagates for zero values defined in CRDM as well as for undefined values identical information, i.e. zeros, to CLM. Consequently, CLM considers the zeros provided by CRDM as "no amount defined", which is considered as no amount limitation

11 Not valid for service party types CLM Transit Account Holder and CLM CB Technical Account Holder.

in the CLM direct debit processing because based on the information provided CLM cannot distinguish between "0 = no amount defined" and "0 = zero amount".

Floor/ceiling

For each MCA or CLM CB Account, a CLM Account Holder or CLM CB Account Holder can define a minimum ("floor") and/or a maximum ("ceiling") amount in CRDM that shall be available for settlement on the respective account.

The CLM Account Holder or CLM CB Account Holder can choose how CLM shall respond in case the floor or ceiling on an account is breached (e.g. after the settlement of a payment order).

Owing to the fact that various objects in CRDM are involved when creating/changing a floor/ceiling configuration there might be certain constellations where the set-up is not complete. In case such invalid/incomplete floor/ceiling configuration is propagated during the regular data propagation for the upcoming business day such incomplete configurations are not considered in CLM for further processing.

Notifications can be sent in A2A and/or U2A. The floor and ceiling notification ([ReturnAccount \(camt.004\)](#) [▶ 380]) is sent via A2A in case the CLM Account Holder (or another actor acting on behalf of the CLM Account Holder) or CLM CB Account Holder has chosen to be notified that way. Further details are provided in chapter [Breach of floor/ceiling threshold - notification](#) [▶ 136].

Preconditions for the generation of a rule-based liquidity transfer order depend on their type:

- I For the creation of a rule-based inter-service liquidity transfer the definition of an "Account to be credited for ceiling breach" and/or an "Account to be debited for floor breach" in CRDM is mandatory. Those accounts have to be RTGS DCAs or RTGS CB accounts. For further details see CRDM UDFS, chapter "*Description of entities > Account Threshold Configuration*".
- I For the creation of a rule-based intra-service liquidity transfer between two MCAs the definition of an "Account to be credited for ceiling breach" and/or an "Account to be debited for floor breach" in CRDM is mandatory. All relevant MCAs need to be part of the same Liquidity Transfer Group (see [Types of groups](#) [▶ 65]).
For further details, see CRDM UDFS, chapter "*Description of entities > Account Threshold Configuration*".
- I For the creation of a rule-based intra-service liquidity transfer between two CLM accounts belonging to a CB the definition of an "Account to be credited for ceiling breach" and/or an "Account to be debited for floor breach" in CRDM is mandatory. For further details, see CRDM UDFS chapter, "*Description of entities > Account Threshold Configuration*".

Note: The set-up of a rule-based liquidity transfer order for floor breach and ceiling breach can be set-up completely independent. Both liquidity transfer orders could be configured as intra-service or inter-service liquidity transfer.

In case of set-up of a rule-based liquidity transfer order between an MCA and an RTGS DCA both accounts can belong to different parties.

In case of set-up of a rule-based liquidity transfer order between two MCAs both accounts can belong to different parties but need to belong to the same Liquidity Transfer Group. There are no such restrictions where a CB Account is involved.

It is up to CLM Account Holders or CLM CB Account Holder to set up and maintain the floor/ceiling information in CRDM. All actions (set up, modify, delete) become effective as of the next business day or on the activation date of the MCA or the CLM CB Account if this is later than the next business day.

More information on floor/ceiling can be found in chapter [Floor/ceiling](#) [▶ 134].

Co-management

The aim of co-management is to allow banks to delegate all or special activities in CLM to a co-manager. For example, in case a CLM Account Holder does not establish an own technical connectivity to access CLM, all activities can be delegated to a co-manager.

During the creation of an MCA, a flag allows CBs to identify that the account is co-managed and who is the co-manager. Co-Manager can only be a CLM Account Holder or a CLM CB Account Holder. The privileges/roles assigned by the CB to the user of the CLM Account Holder or CLM CB Account Holder are also applicable for the co-managed account without limitations. This means that in case the user of the CLM Account Holder or CLM CB Account Holder has the privilege to query the account balance, the user can see the balance of the account(s) in the data scope of his party and in addition the balance of the co-managed account.

During the creation of the party, the party technical address of the co-manager must be entered if the co-manager wishes to receive the messages related to the co-managed account(s).

Co-management allows a CLM Account Holder or a CLM CB Account Holder (i.e. the co-manager) to manage the MCAs of other CLM Account Holders (i.e. co-managed accounts). This means that the co-manager can e.g.:

- | initiate liquidity transfer orders ([camt.050](#) [▶ 505]) on the co-managed MCA (including the set-up of overnight deposits on the overnight deposit account linked to the co-managed CLM Account Holder);
- | create, modify and delete a current reservation and standing order for reservation on the co-managed MCA;
- | receive status notifications (i.e. [camt.054](#) [▶ 520]) on cash transfers and tasks for the co-managed MCA;¹²
- | set-up report configuration in CRDM related to the co-managed accounts;
- | set-up of rule-based liquidity transfers;
- | receive the report “statement of accounts” ([BankToCustomerStatement \(camt.053\)](#) [▶ 511]) for the co-managed MCA(s);¹³

¹² In order to receive messages, a routing configuration with the party technical address of the co-manager and message subscription must be set up.

- | initiate overnight deposits and overnight deposit reverse orders on the overnight deposit account linked to the co-managed CLM Account Holder and;
- | submit query requests to CLM to request information about the co-managed account(s) with regards to: e.g. account, available liquidity, cash transfer(s) and minimum reserve.

Note: minimum reserve information on the co-managee apart from cash account balance of the co-managed account is only available for the co-manager in case

- the co-manager is the leading CLM Account Holder of the co-managee (indirect or pool minimum reserve set-up) or
- the co-manager is not the leading CLM Account Holder of its co-managee, but the co-managee
 - (i) holds its minimum reserve directly and
 - (ii) owns only one MCA and no further account(s) in any TARGET settlement service (i.e. CLM, RTGS, TIPS, T2S) and
 - (iii) is not the leading CLM Account Holder of other parties holding the minimum reserve indirectly

All the activities in CLM can be done in A2A or U2A, depending on the set-up of the respective co-manager. The co-manager and the owner of the co-managed account do not need to be technically under the same system entity of a CB.

Note: In case certain conditions are met, CLM will use data related to routing and message subscription which was set up for the party of the co-manager and is valid on the upcoming business day in the respective currency also for the co-managee party. Details can be found in chapter [Messaging](#) [▶ 59].

Standing order liquidity transfer order

A standing order liquidity transfer order is a recurring order of a CLM Account Holder or a CLM CB Account Holder to transfer:

- | once per business day;
- | at a configured business day event;
- | a defined amount of liquidity;
- | from an MCA or a CLM CB Account to another cash account;
- | over a period with or without a predefined end date.

This information is defined at the level of the MCA or CLM CB Account and it is up to the CLM Account Holder or CLM CB Account Holder to create, configure and manage its standing order liquidity transfer orders information in CRDM.

Set-up and modification of standing order liquidity transfer orders become effective as of the next business day.

13 In order to receive the report, a report configuration for the co-manager must be set up.

The following use cases for standing order liquidity transfer orders are possible for an MCA or CLM CB Account:

- | intra-service liquidity transfer between different MCAs in CLM (within a defined Liquidity Transfer Group);
- | intra-service liquidity transfer between an MCA and a CLM CB Account (if the creditor is a CB Account);
- | inter-service liquidity transfer from an MCA or a CLM CB Account to a cash account in another service (i.e. RTGS, T2S or TIPS).

In case a configuration for a standing order liquidity transfer is propagated which is not considered as valid by CLM such standing order liquidity transfer will not exist on the upcoming business day in CLM.

Further details on liquidity transfers can be found in the chapter [Liquidity transfer](#) [▶ 119].

Standing order for reservation

A standing order for reservation is an instruction of a CLM Account Holder to set up a reservation:

- | of a fixed amount;
- | for a business day;
- | on an MCA;
- | without a predefined end date.

An existing standing order for reservation can be modified or deleted. All actions (set up, modify, delete) become effective as of the next business day or on the activation date of the MCA if this is later than the next business day.

The reservation remains valid until it is modified or deleted. The reserved liquidity is only available for the settlement of CBOs.

It is up to the CLM Account Holders to set up and maintain its standing order for reservation information in CRDM.

Current reservation

For the execution of CBOs CLM Account Holders can set up a current reservation on liquidity in CLM. An existing reservation can be modified and/or deleted. All activities (set up, modify, delete) become effective immediately.

In case the amount changes to "0" the reservation is deleted automatically. Nonetheless a reactivation is possible during the business day.

This information is defined at the level of the MCA and it is up to CLM Account Holders to set up and maintain the current reservation in CLM.

3.2.4 Messaging

This chapter provides an overview about the CLM specification regarding report configuration and routing configuration.

Message subscription

Detailed information can be found in the CRDM UDFS, chapter “*Message subscription*”.

Note on co-management related aspects:

In case the co-managee and the co-manager party are not set up as “U2A-only” at CLM party service link level and the following conditions are met, CLM will copy the message subscription information of the co-manager also for the co-managee for further usage in CLM:

- I The co-managee party has defined a routing for CLM with the same PTA and the same Network Service as the co-manager party (either own or copied from co-manager – see section Routing configuration in this chapter) and this PTA is used for the default routing of the co-manager.
- I The co-managee party has not defined a message subscription for camt.054 in CLM.
- I The co-manager party has defined a message subscription for camt.054 in CLM, which is generic: it has a rule parameter on message type = camt.054, and no other parameter (i.e. no account and no business case code).

Before CLM checks the message subscription data, it will be checked whether any routing configuration of the co-manager is to be loaded for the co-managee in case of certain conditions.

Report configuration

The CLM actor can configure one standard report (statement of accounts) that CLM shall create during the end-of-day (EoD) period. CLM Actors can specify in their report configuration, whether such report shall be sent to the recipient immediately in A2A mode (push) or be stored for later query in A2A and U2A.

In addition, each report configuration defines the possible recipients, which can be either the report owning party itself, the responsible CB or any other party (e.g. a co-manager). This information is defined at the level of the cash account and it is up to the CLM Actor to set up and maintain the report configuration in CRDM.

Further information on the report generation is provided in chapter [CLM report generation](#) [▶ 161].

Routing configuration

The routing configuration defines the technical address to which reports and notifications are sent to. This does not apply e.g. [PaymentStatusReport \(pacs.002\)](#) [▶ 615] (if subscribed) and [Receipt \(camt.025\)](#) [▶ 479] as these messages are always returned to the sender of the underlying message.

Routing for each message type is configured at party level and it is up to the CLM Actor to set up and maintain the report configuration in CRDM. The routing configuration (and the amendment) becomes effective as of the next business day.

More details on routing can be found in chapter [Communication between CLM and CLM Actors](#) [▶ 38].

Note on co-management related aspects:

In case the co-managee and the co-manager party are not set up as “U2A-only” at CLM party service link level and the following conditions are met, CLM will copy the default routing information of the co-manager also for the co-managee for further usage in CLM:

- | The co-manager party has defined a default routing for CLM.
- | The co-managee party has not defined any routing for CLM.
- | The co-managee party has the same Party Technical Address (PTA) for the same Network Service (linked via Technical Address Network Service Link) as the co-manager party and this PTA is used for the default routing of the co-manager.

3.2.5 Blocking/unblocking account

It is possible to block cash accounts in CLM. Blocking is done by the responsible CB. The blocking of cash accounts is possible for:

- | credit and debit;
- | debit;
- | credit.

When blocking a cash account in CRDM, the blocking request includes a valid from date. If the valid from date is specified as the current business date, the blocking becomes effective immediately. The same behaviour is applicable for the unblocking of cash accounts regarding the valid to date. When unblocking a cash account for a future business date, the valid to date is considered as excluded, i.e. the cash account is unblocked on the specified valid to date.

In case CRDM marks the cash account as blocked for credit and debit, credits and debits without prior confirmation of the respective CB are not allowed on the cash account. If the cash account is blocked for debit, credits are still allowed on this cash account. The reverse logic applies in case of blocking for credit (debits are allowed).

Further details on the processing of cash transfer orders in case of blocking are provided in chapter [Impact of blocking on the processing of cash transfer orders](#) [▶ 171].

Note: Regardless of the blocking of a CLM Account Holder, it is possible to close the account of a CLM Account Holder. This closure is a regular process. It becomes effective the next business day or at a predefined business day in the future.

3.2.6 Closing of accounts still containing a balance

In case:

- | An account is foreseen to be closed as of next business day;
- | and there is still money on that account after business day event “CB cut-off for standing facilities” of the current business day;

then CLM will generate a liquidity transfer.

On one side empties the position on the account (zero balance). On the other side this balance is credited on the default CB Account of the CB the CLM Account Holder belongs to (see chapter [Process business day event “CB cut-off for standing facilities”](#) [▶ 272]). If the CLM account has a negative balance, the debtor and creditor side are changed within this cash transfer.

This applies to all kind of cash accounts.

3.3 Static data configuration for minimum reserve management and interest calculation

The minimum reserve management (including the management of excess reserves) as well as the interest calculation for possible other purposes is set up and maintained by CBs for the following service party types in CLM:

- | CLM Account Holder;
- | institution managing minimum reserve without account in CLM.

To cover the minimum reserve requirements on service party type level for each CLM Account Holder, that is subject to minimum reserve obligation, the CB needs to define a leading CLM Account Holder (either the CLM Account Holder the set-up is for or another CLM Account Holder¹⁴).

Also for service party type “institution managing minimum reserve without account in CLM” a leading CLM Account Holder needs to be defined by the CB on service party type level. In addition, the minimum reserve obligation shall be defined at party service link level (CLM Account Holder) and shall apply to all cash accounts held by the related party in all settlement services, i.e. CLM, RTGS, TIPS and T2S (with the exception of the accounts not to be included in the minimum reserve calculation).

The following attributes are foreseen at party service link level to cover the minimum reserve requirement:

14 Belonging to the same CB.

Attribute	Mandatory/Optional	Values	Definition
Minimum reserve obligation	Mandatory	Direct Pool Indirect No	Indicates if an institution is subject to minimum reserve requirement or not and the type of the minimum reserve calculation. Must be set to "Indirect" or "Pool" if the party service type is "Institution managing minimum reserve without account in CLM". For non-Euro CBs the attribute must be set to "no".
MFI code	Optional	Code	Monetary Financial Institution (MFI) code. To be filled if minimum reserve obligation = "Pool", "Indirect" or "Direct". Must be empty if minimum reserve obligation = "No".
Leading CLM Account Holder	Optional	BIC11 (party BIC)	Indicates the leading CLM Account Holder for the calculation and settlement of interest and/or penalties. Mandatory if minimum reserve obligation = "Pool", "Direct" or "Indirect". Optional if minimum reserve obligation = "No".

Table 7 - Minimum reserve management at party service link level

On account level a default MCA has to be defined for the leading CLM Account Holder for the interest/penalty settlement valid for all linked account holders.

An MCA is a prerequisite for the calculation and the settlement of related interest or penalties (for minimum reserves, excess reserves and possible other purposes). This requires that for each CLM Account Holder the CB has defined a leading CLM Account Holder as described above for the purpose of:

- I minimum reserve management (including excess reserves);
- I calculation of interest for minimum reserves, excess reserves and possible other purposes;

I settlement of calculated interest.

It is up to the CB to set up dedicated minimum reserve management and interest calculation attributes on account level defined for their account holders linked to all settlement services.

In addition to MCAs/DCAs/TIPS Accounts, other cash account types need to be remunerated as well (e.g. CB accounts of non-Euro area CBs, AS guarantee funds accounts and AS technical accounts related to AS settlement procedure D).

The remuneration of the excess of the minimum reserve requirements is split and remunerated with two different interest rates.

To allow flexibility in remunerating of different account types, cash accounts in all settlement services can be included or excluded from the minimum reserve calculation.

In case of exclusion from the minimum reserve calculation, a further configuration at account level enables the calculation of possible other interest to be settled on these accounts.

The following list of attributes is foreseen at account level for each cash account in all settlement services, i.e. CLM, RTGS, TIPS and T2S, for the minimum reserves management and interest calculation:

Attribute	Mandatory/Optional	Values	Definition
Default (applicable to CLM only)	Mandatory	Yes/no	Indicates the default MCA where the minimum reserve/interest/penalties shall be settled.
Minimum reserve calculation	Optional	Yes/no	Indicates whether the account balance is included in the minimum reserve calculation. Only relevant if "minimum reserve obligation" on party service link level is set to "Direct" or "Pool".

Attribute	Mandatory/Optional	Values	Definition
Interest calculation	Optional	<p>Three possible values:</p> <ul style="list-style-type: none"> no; minimum reserve calculation period; monthly. 	<p>Indicates whether interest is calculated on the account balance. Only relevant if the attribute “minimum reserve calculation” at account level is set to “No”.</p> <p>If not set to “No”, this field indicates the interest calculation period to be used for interest calculation.</p> <p>Note: In general, for marginal lending¹⁵ and overnight deposit account the attribute must be set to “No” as the interest calculation is not subject to any configuration.</p> <p>Exception: For overnight deposit accounts of Out-CBs this field must be set to “monthly”.</p>
Rate type for interest calculation	Optional	<p>All available interest rates (incl. SF interest rates and excess reserve interest rates, also zero available as possible value)</p> <p>For rate types and code words refer to Shared reference data [68]</p>	<p>Indicates the rate type to be used for “interest calculation”.</p> <p>This information is only relevant if “interest calculation” is set to a value different from “No”.</p>
Automated generation of interest payment (system generated)	Optional	Yes/no	Indicates whether interest payment is automatically generated by CLM.

Table 8 - Minimum reserve and interest calculation management at account level

15 Only relevant until go-live of ECMS

More information on the minimum reserve management and interest calculation can be found in chapter [Minimum reserve management and interest calculation](#) [▶ 139] as well as in chapter [Minimum reserve management and interest calculation - specific functions for CBs](#) [▶ 202].

3.4 Types of groups

Groups are used to cluster parties or accounts for different business purposes. It is possible to set up and maintain a Liquidity Transfer Group, a Banking Group and an Account Monitoring Group in CRDM.

The following table summarises the configuration responsibilities for each reference data object related to groups in CRDM and specifies the required communication mode:

Reference data object	Responsible actor	Entities	Mode
Banking Group	CB	Parties	U2A
Account Monitoring Group	CLM Account Holder	Accounts	U2A
Liquidity Transfer Group	CB	Accounts	U2A

Table 9 - Set-up of groups for CLM

Further details on the set-up of the various groups are provided in the CRDM UHB, chapter "*Create a Cash Accounts Group*".

Banking Group

A Banking Group is an optional group of parties which can be used in the CLM. It grants a collective view over the liquidity of the involved parties to CBs. A Banking Group is used for liquidity monitoring purposes of CBs; they are not used for the context of payment orders or liquidity transfer orders settlement.

CBs can set up a Banking Group and specify the name of this group in CRDM. The CB which sets up the Banking Group is defined as leader party of the Banking Group. All actions (set up, modify, delete) become effective as of the next business day or on the activation date. Each CB can then optionally link a party for which it is responsible to a Banking Group.

A Banking Group can include different parties belonging to one or multiple CBs. In such a case, the responsible CB of the party links the relevant party to the Banking Group. These parties can be linked to different settlement services (e.g. CLM, RTGS, T2S, TIPS).

Only CBs have the visibility of the accounts and balances of accounts within the defined Banking Group. Payment banks or Ancillary Systems belonging to the Banking Group are still limited to their own data scope (accounts). The liquidity of the central bank which is always defined as banking group leader is not included in the aggregated liquidity information of the banking group.

The following figure gives an example of a Banking Group set-up:

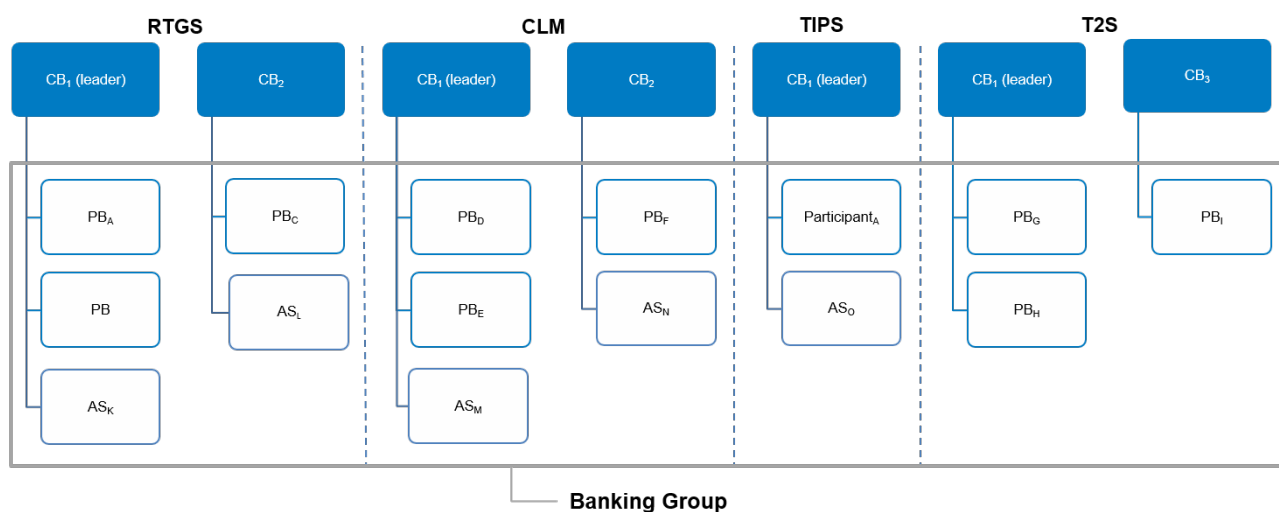

Figure 7 - Banking Group

Account Monitoring Group

An Account Monitoring Group is an optional group of accounts (MCA(s), DCA(s) and TIPS Account(s)) which can be used in the CLM. It grants a collective view over the liquidity of the involved accounts to payment banks. An Account Monitoring Group is used for liquidity monitoring purposes of payment banks; they are not used for the context of payment orders or liquidity transfer orders settlement. The leader party of the Account Monitoring Group can see the liquidity of all included accounts while the other participants of the Account Monitoring Group can only see the liquidity of their accounts.

Payment banks can set up an Account Monitoring Group and specify the name of this group in CRDM. The Account Holder, which sets up the Account Monitoring Group, is defined as leader party of the Account Monitoring Group. Each payment bank can then optionally add MCAs in his data scope to the Account Monitoring Group. All actions (set up, modify, delete) become effective as of the next business day or on the activation date.

The leader party of the Account Monitoring Group has to be an account holder in CLM. It can be changed in case of need by the responsible CB.

An MCA can be included in one or several Account Monitoring Groups. An Account Monitoring Group can include accounts owned by several parties belonging to one or multiple CBs. In such a case, the account holder links its relevant accounts to the Account Monitoring Group. These parties can be linked to different settlement services (e.g. CLM, RTGS, T2S, TIPS).

The following figure gives an example of an Account Monitoring Group set-up:

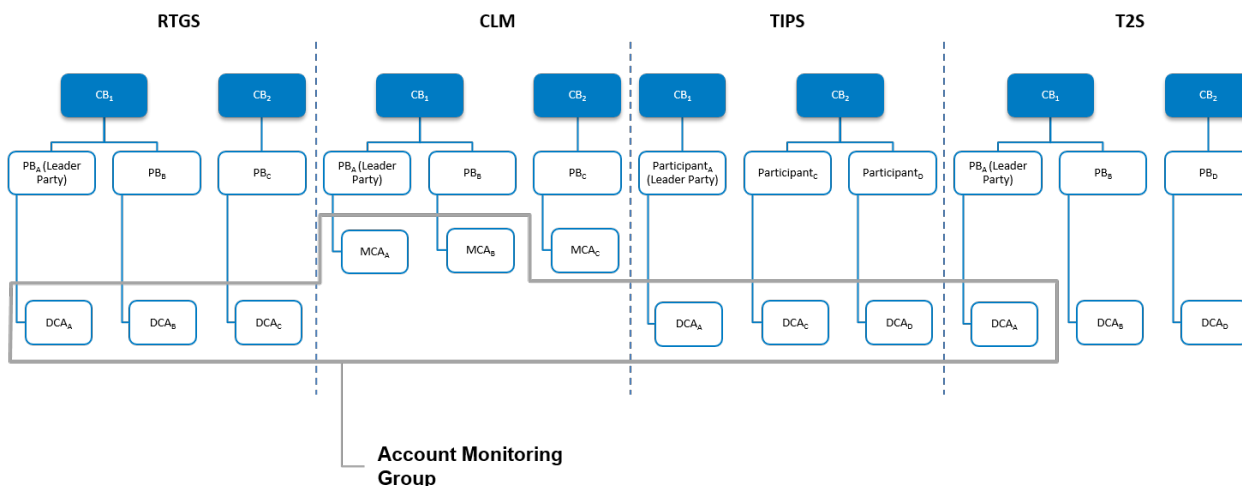

Figure 8 - Account Monitoring Group

Liquidity Transfer Group

A Liquidity Transfer Group is an optional group of MCAs. CBs can set up Liquidity Transfer Groups to allow intra-CLM liquidity transfers between them (not for liquidity monitoring purposes). Intra-service liquidity transfers between two MCAs can only take place between accounts belonging to the same Liquidity Transfer Group¹⁶. There are no such restrictions on intra-service liquidity transfers, where a CB Account is involved.

CBs can set up a Liquidity Transfer Group and specify the name of this group. All actions (set up, modify, delete) become effective as of the next business day or on the activation date. Each CB can then optionally add MCAs for which it is responsible to a Liquidity Transfer Group.

An MCA can be included in one or several Liquidity Transfer Group(s). A Liquidity Transfer Group can include MCAs owned by several parties belonging to one or multiple CBs. In such a case, the responsible CB of the party links the relevant MCAs to the Liquidity Transfer Group.

The following figure gives an example of a Liquidity Transfer Group set-up:

16 The execution of inter-service liquidity transfers is possible without checking on which groups the accounts belong to.

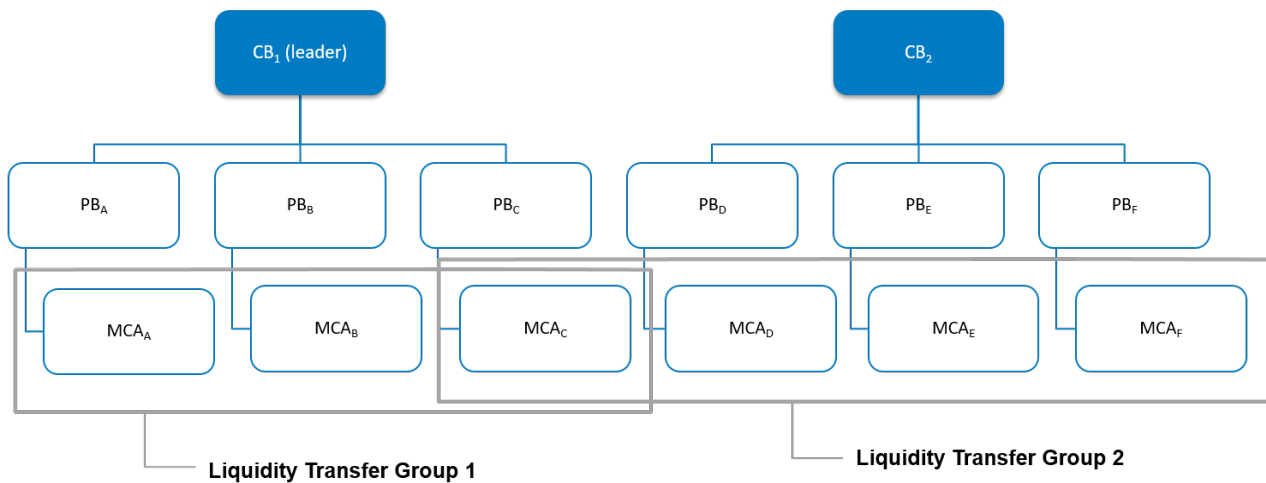

Figure 9 - Liquidity Transfer Group

3.5 Shared reference data

CLM calendar and scheduled events

The CLM calendar specifies the calendar days when CLM is open and follows the defined business day schedule. The closing days for different currencies are included in this calendar.

The CLM scheduled events automatically trigger a specified process within CLM. Each event might trigger one or several other events. The other way round, each event might be triggered by one or several trigger events.

It is up to the operator to set up and maintain the CLM calendar and the scheduled events. All actions (set up, modify, delete) become effective as of the next business day.

For further information refer to chapter [Business day](#) [73].

CLM currency

The CLM currency specifies the available settlement currencies in CLM. It is up to the operator to set up and maintain the settlement currencies. All actions (set up, modify, delete) become effective as of the next business day.

The following table shows the attributes of the currency in CLM:

Attribute	Description
Currency code	It specifies the three-character ISO currency identifying the currency.
Currency name	It specifies the name of the currency.
Number of decimals	It specifies the number of decimals for the currency.

Table 10 - Attributes of the CLM currency

CLM rates

The CLM rates specify the available rates in CLM (e.g. for minimum reserve calculation). It is up to the operator to set up and maintain the CLM rates. All actions (set up, modify, delete) become effective as of the next business day.

The following table shows the attributes of the CLM rates:

Attribute	Description
Rate type	It specifies the type of rate amongst an exhaustive list of values: <ul style="list-style-type: none"> minimum reserve interest rate (MRIR); minimum reserve penalty rate type 1 (MRP1); minimum reserve penalty rate type 2 (MRP2); excess reserve interest rate (tier 1) (EXRE); excess reserve interest rate (tier 2) (EXRR); overnight deposit interest rate (ODIR); marginal lending interest rate (MLIR).¹⁷
Validity period	It specifies the start and end date of the rate validity period.
Rate (%)	It specifies the rate value (zero value also possible).

Table 11 - Attributes of the CLM rates

Reserve maintenance period

This reference data object provides general information on the reserve management maintenance periods. It is up to the operator to set up and maintain the reserve maintenance periods. All actions (set up, modify, delete) become effective as of the next business day.

The following table shows the attributes of the reserve maintenance periods in CLM:

¹⁷ Only relevant until go-live of ECMS, then value not used anymore

Attribute	Description
Maintenance period ID	It specifies the ID of the reserve maintenance period.
Minimum reserve period start	It specifies the start date of the maintenance period.
Minimum reserve period end	It specifies the end date of the maintenance period.

Table 12 - Attributes of the reserve maintenance periods

Duplicate check

There are duplicate checks on:

- | files and individual messages received (for A2A communication only);
- | payment and liquidity transfer orders at business validation level.

The system parameters regarding duplicate checks for inbound files/messages are defined in the table below.

No specific configuration by the CLM Actor is required. It is up to the operator to set-up and to maintain the duplicate check parameter. All actions (set up, modify, delete) become effective as of the next business day:

Concerned process	Parameter	Created by	Updated by	Mandatory/optional	Standard or default value
Message/File Duplicate Check	Number of business days in the past for duplicate check on files and individual messages	Operator	Operator	M	1 business day (same business day)
Liquidity transfer order duplicate check	Number of business days in the past for duplicate check on liquidity transfer orders	Operator	Operator	M	5 business days
Payment order duplicate check	Number of business days in the past for duplicate check on payment orders	Operator	Operator	M	1 business day (same business day)

Table 13 - Attributes of the duplicate check

Warehoused payment period

It is possible to send warehoused payment orders up to ten calendar days in advance to CLM. The payment message shall pass technical and business validations and shall be warehoused until CLM opens for that date. The system parameter regarding the warehoused payment period is defined in the table below. It is up to the operator to set up and to maintain the warehoused payment period parameter. All actions (set up, modify, delete) become effective as of the next business day. No specific configuration by the CLM Actor is required:

Concerned process	Parameter	Created by	Updated by	Mandatory/optional	Standard or default value
Warehoused payment period	Number of calendar days in the future for warehoused payment orders	Operator	Operator	M	Ten calendar days

Table 14 - Attributes of the warehoused payment period

3.6 Local reference data

Local reference data maintenance within CLM is limited to the following set of operations with immediate effect:

- | creation, modification and deletion of current reservations for CBOs¹⁸;
- | creation, modification and deletion of current reservations for seizure of funds¹⁹;
- | creation, modification and deletion of credit lines²⁰.

3.7 Interaction between CLM and CRDM

CRDM provides features that allow duly authorised users to set up, update, delete and query all reference data that are shared by multiple services/components (e.g. CLM or RTGS) for their processing activities.

18 When a standing order reservation for CBOs maintained in CRDM is processed in CLM at SoD, it becomes a current reservation in the local reference data of CLM. Current reservations can be also created via A2A or U2A when no standing order has been set up. Current reservations for CBOs are deleted by CLM at the end of the business day.

19 Reservation for seizure of funds is created by a CB as a current reservation in CLM (standing order is not available for this reservation type). The seizure of funds reservations are not deleted by CLM at the end of the business day.

20 Credit lines on MCAs can be managed by a CB via A2A or U2A. Credit lines are not deleted by CLM at the end of the business day. A credit line modification ([camt.998_ModifyCreditLine](#) [578]) with currency 'EUR' is not allowed by a CB after ECMS go-live.

It is ensured that CRDM propagates common reference data (and their changes) to the relevant services and components timely and consistently. Further detailed information can be found in chapter [CRDM](#) [▶ 176] and in the CRDM UDFS, chapter "*Common reference data propagation*".

As far as CLM is concerned, reference data set-up and maintenance operations are performed in CRDM with the exception of changes on local data which are performed in CLM directly.

The agreed concept in CRDM allows it to set up certain information without validity date in CRDM as the data is related to other CRDM objects with validity dates or objects without validity dates.

Especially in case data without validity dates (e.g. PTA) refers to CRDM objects (e.g. Party) with a validity date which is not relevant in CLM for the upcoming business day in the respective currency, the data cannot be considered in CLM in the local data model for further processing. This is mainly the case for CRDM data referring to parties and/or cash accounts not valid on the upcoming business day in the respective currency due to the fact the party/cash account is closed or only valid as of a future date.

It is worth highlighting that the usage of data not valid on the upcoming business day for the respective currency has the consequence that CLM cannot consider the complete data row for further processing. Therefore, it is of utmost importance that the users in CRDM ensure a consistent set-up.

The reference data stored in CRDM are propagated from the CRDM to CLM asynchronously, on a daily basis. The only exception is the blocking and unblocking of parties and accounts. This is done in CRDM and is propagated immediately to CLM.

Every CRDM opening day, all CLM reference data is propagated from CRDM to CLM. For detailed information on the reference data propagation, refer to chapter [Overview description of the business day](#) [▶ 76] as well as the CRDM UDFS, chapter "Common reference data propagation".

Changes to local reference data in CLM are not propagated to CRDM.

4 Business day

4.1 T2 calendar

The T2 calendar defines the working and closing days for CLM. The operator maintains the T2 calendar which is managed by BDM. CLM and RTGS are using the T2 calendar.

In general, working days are all calendar days from Monday to Friday, excluding days which are defined as closing days. Closing days are calendar days where no operations in CLM are possible. The closing days in the T2 calendar may differ per currency.

In addition to Saturday and Sunday, the following T2 closing days are defined for Euro currency:

- | New Year's Day (1 January);
- | Good Friday (Catholic/Protestant);
- | Easter Monday (Catholic/Protestant);
- | Labour Day (1 May);
- | Christmas Day (25 December);
- | Boxing Day (26 December).

A business day is the timeframe where the CLM processes are conducted. It starts with the "Change of business day" and lasts until the next "Change of business day". The timeframe is decoupled from normal working day durations.

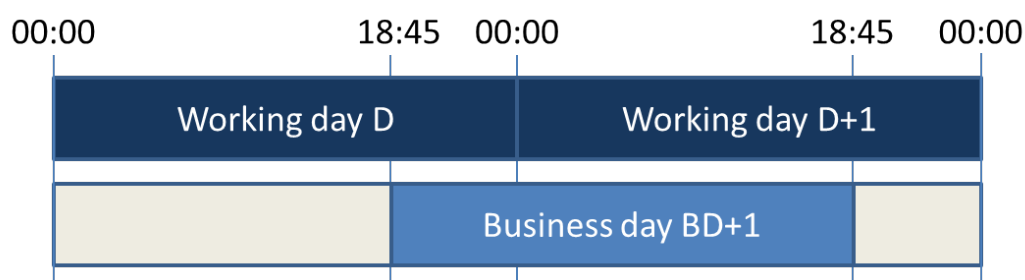

Figure 10 - CLM business day

In the evening of every working day a new business day starts, with the date of the next working day according to the T2 calendar. The business day is completed on the next working day. In CLM, the business day is expected to start at 18:45 CET on working day D and to end at 18:45 CET (Central European Time) on working day D+1.

Example – T2 closing day during the week

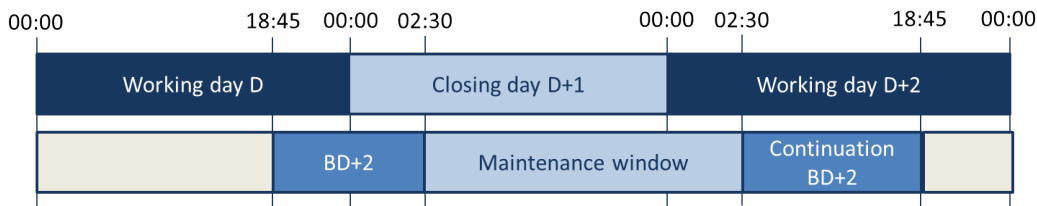

Figure 11 - T2 closing day during the week

On the working day D before the T2 closing day D+1, the new business day is opened with the date of the next working day D+2.

On the closing day D+1 CLM enters the maintenance window and remains in maintenance until the closure of the maintenance window on working day D+2.

Example – currency-specific closing day during the week

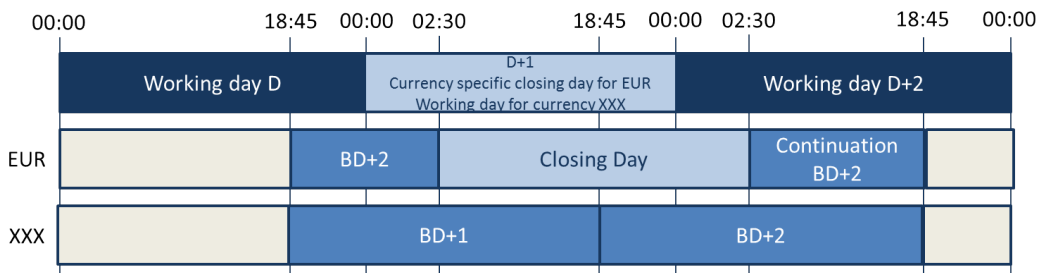

Figure 12 - Currency-specific closing day during the week

On the working day D before the currency specific closing day for EUR D+1, the new business day is opened with the date of the next working day D+2 for EUR.

On the currency specific closing day D+1 CLM is closed for EUR from 02:30 CET at the closing day and remains closed until 02:30 on working day D+2. All other currencies follow their standard CLM schedule.

Example – Saturday and Sunday as T2 closing days

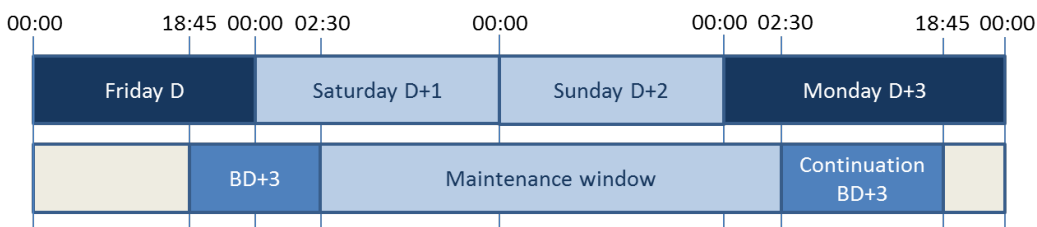

Figure 13 - Saturday and Sunday as T2 closing days

On the working day Friday, the new business day is opened with the date of the next working day, Monday D+3 in the example.

CLM enters the maintenance window on Saturday and remains in maintenance until closure of maintenance window on Monday.

4.2 CLM schedule

The CLM schedule defines the order and times of CLM periods with the related events and processes during a business day. It is under control of the operator who is able to perform temporary or permanent changes to the CLM schedule. The CLM schedule is managed by BDM.

The CLM business day is organised in different periods (see chapter [Overview description of the business day](#) [▶ 76]). A period is always started by a dedicated event and ends with the event, which defines the start of the next period. Additional events can exist within a period. Events can be time-based or not time-based. Events which are not time-based depend on the occurrence of the defined previous event and the completion of the associated processes. Events which are time-based depend on the occurrence of the defined previous event, the completion of the associated processes and the achievement of the defined point in time for this time-based event. For each time-based event, a planned time and a revised time is managed. For each event (time-based and not time-based) an effective time is stored.

- I The planned time corresponds to the standard schedule applied by default for every business day. For all time-based events the planned time defines the earliest point in time an event can occur. Some time-based events depend in addition to the defined time on the completion of processes associated to the previous event. The operator can update this planned time in case of a permanent change in the regular schedule.
- I The revised time is the foreseen time for the current business day which usually coincides with the planned time except when a delay has occurred. In contingency situations, the operator updates the revised time while the planned time remains unchanged.
- I The effective time is the time of the actual occurrence of the event during the current business day. It can only deviate from the planned or revised time if the processing linked to the previous business day event is not completed in time.

Time-based events can have a cut-off for defined operations. Operations arriving later than the planned or revised time linked to the cut-off event are rejected.

Processing linked to events is triggered at the effective time.

Planned times can be changed by the operator under the condition that the sequence and order of linked events remains unchanged.

The planned times of certain events can be defined currency-specific. The sequence of events cannot be changed. An exhaustive list of which the later described events may be defined per currency is described in chapter [List of events](#) [▶ 91].

CLM Actors can subscribe to a notification message in order for them to be informed about the current system status. CLM provides a push notification when certain events are triggered. Further details are provided in [List of events](#) [▶ 91].

All times shown in this document are the planned times and therefore indicative. All times refer to Central European Time (CET) or Central European Summer Time (CEST), where applicable²¹.

4.3 Overview description of the business day

The business day in CLM is structured in four periods:

- | start-of-day (SoD);
- | CLM real-time settlement (CLM RTS);
- | maintenance window (for TARGET Services) if activated;
- | end-of-day (EoD).

Each **period** of the CLM business day includes different processes as detailed in chapter [Detailed description of the business day](#) [▶ 80].

CLM RTS comprises two **settlement windows**: (i) for CBOs and (ii) liquidity transfer orders. With the exception of the settlement window for liquidity transfer orders, which opens half an hour after the “Start of CLM RTS”, the settlement windows are open during the complete duration of the CLM RTS period. Settlement windows are closed by **cut-offs** that may differ per currency. The maintenance window is not affecting the status of any cash transfer order.

There are two kinds of maintenance windows:

- | the non-optional maintenance window on business days after T2 closing days, including every business day Monday;
- | the optional maintenance window on every other business days (Tuesday to Friday; not following a T2 closing day).

Details on the periods of the CLM business day and the respective settlement windows can be found in the following chapter [Detailed description of the business day](#) [▶ 80].

Due to the optionality of the maintenance window there are two kinds of business day schedules. The high-level schedule below shows the different periods and settlement windows for CLM business days after T2 closing days:

²¹ For reasons of simplification, only CET is used in the following sections of the document, without any additional indication of CEST, even though times always refer to either CET or CEST, depending on whether winter or summer time applies.

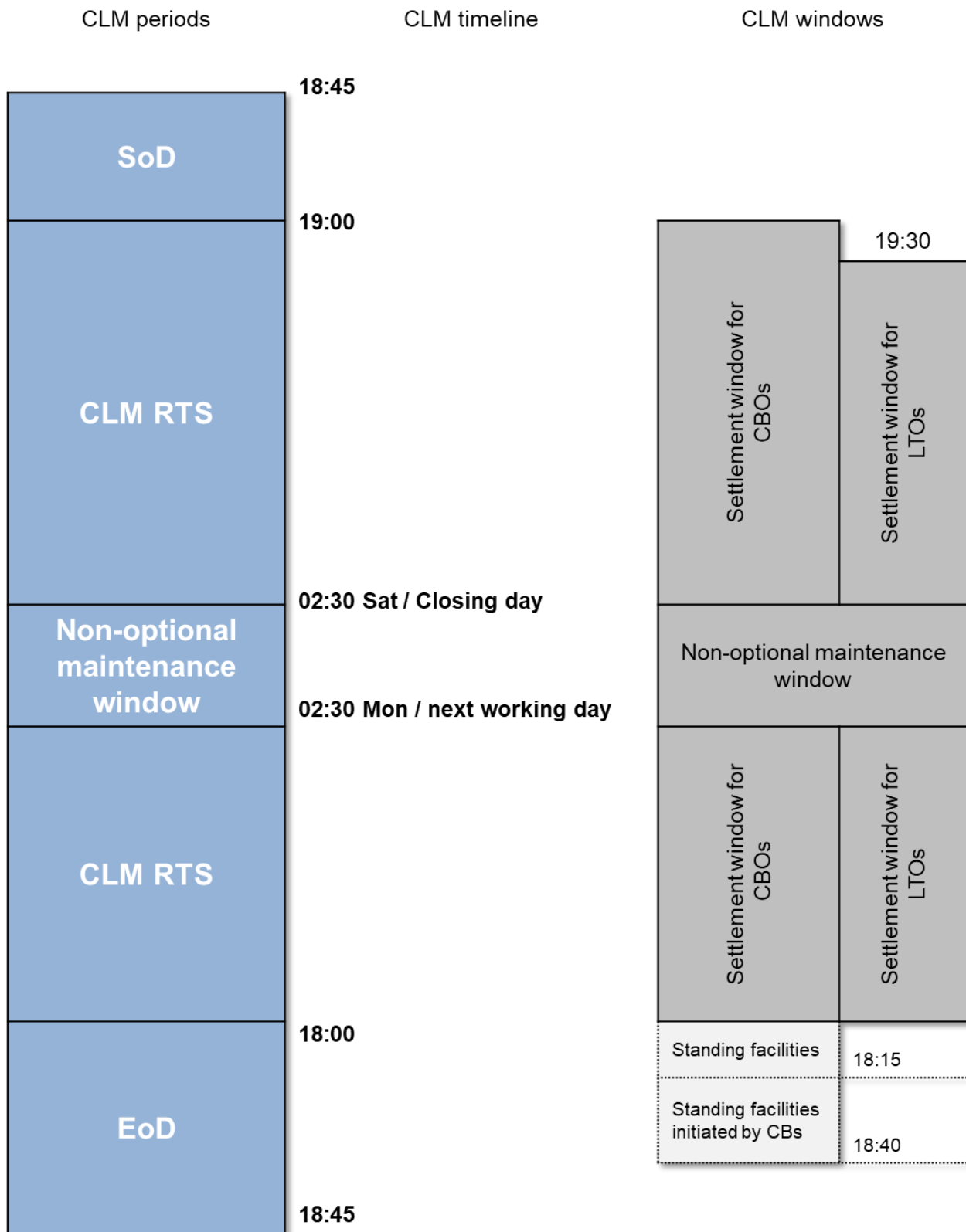

Figure 14 - CLM high-level schedule with non-optional maintenance window

The high-level schedule below shows the different periods and settlement windows during every other CLM business day (Tuesday to Friday; not following a T2 closing day).

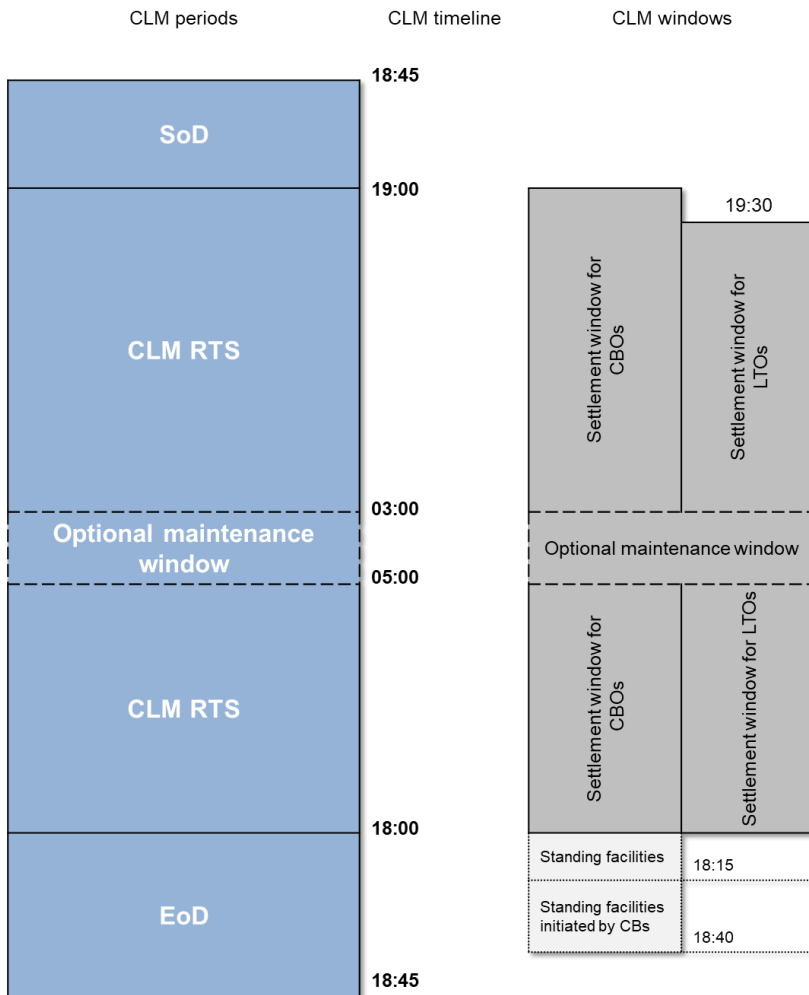

Figure 15 - CLM high-level schedule with optional maintenance window

Access to DWH and GUI is available during all periods except for the maintenance window.

Reference data are captured in CRDM. Details are provided in the CRDM UDFS, chapter "Common Reference Data" and in the CRDM UHB, chapter "Party Management" and "Account Management". For reference data to be valid as of the next business day it must be captured before the event T2DP that propagates data from CRDM to CLM. For further details, please see the CRDM UDFS, chapter "Interactions with other services" > "TARGET Instant Payment Settlement and T2", with a planned time of 18:00 CET. The event T2DP triggers the propagation of all CLM reference data from CRDM to CLM. The data propagated from CRDM is taken over in a two-step approach. The event T2D2 "Data propagation for T2 (CLM & RTGS)" triggers the validation and storage in CLM. It is a direct successor of T2DP. The reference data for the next business day is activated after finalisation of the EoD processing (event CCOS) and will be visible in CLM after the next SoD.

The propagation, validation and storage takes place in parallel to the EoD processing, in order to allow CLM to load the reference data for a smooth and complete reference data propagation.

Currency specific closing days

As closing days may differ per currency, there are business days where CLM is closed for operations in one currency, while operations in another currency are possible, i.e. currency specific closing days. Details about the handling of currency specific closing are provided in chapter [Currency specific closing](#) [▶ 90].

Schedule on the last business day of the minimum reserve maintenance period

On the last business day of the minimum reserve maintenance period after the closure of CLM RTS, the timeframe to request standing facilities is extended by additional 15 minutes. As a consequence, all EoD cut-offs are postponed by 15 minutes as described in chapter [End-of-day period \(18:00 - 18:45 CET\)](#) [▶ 87].

The high-level schedule below shows the influence of this extension of the EoD period on the other CLM periods and on the settlement windows in CLM RTS.

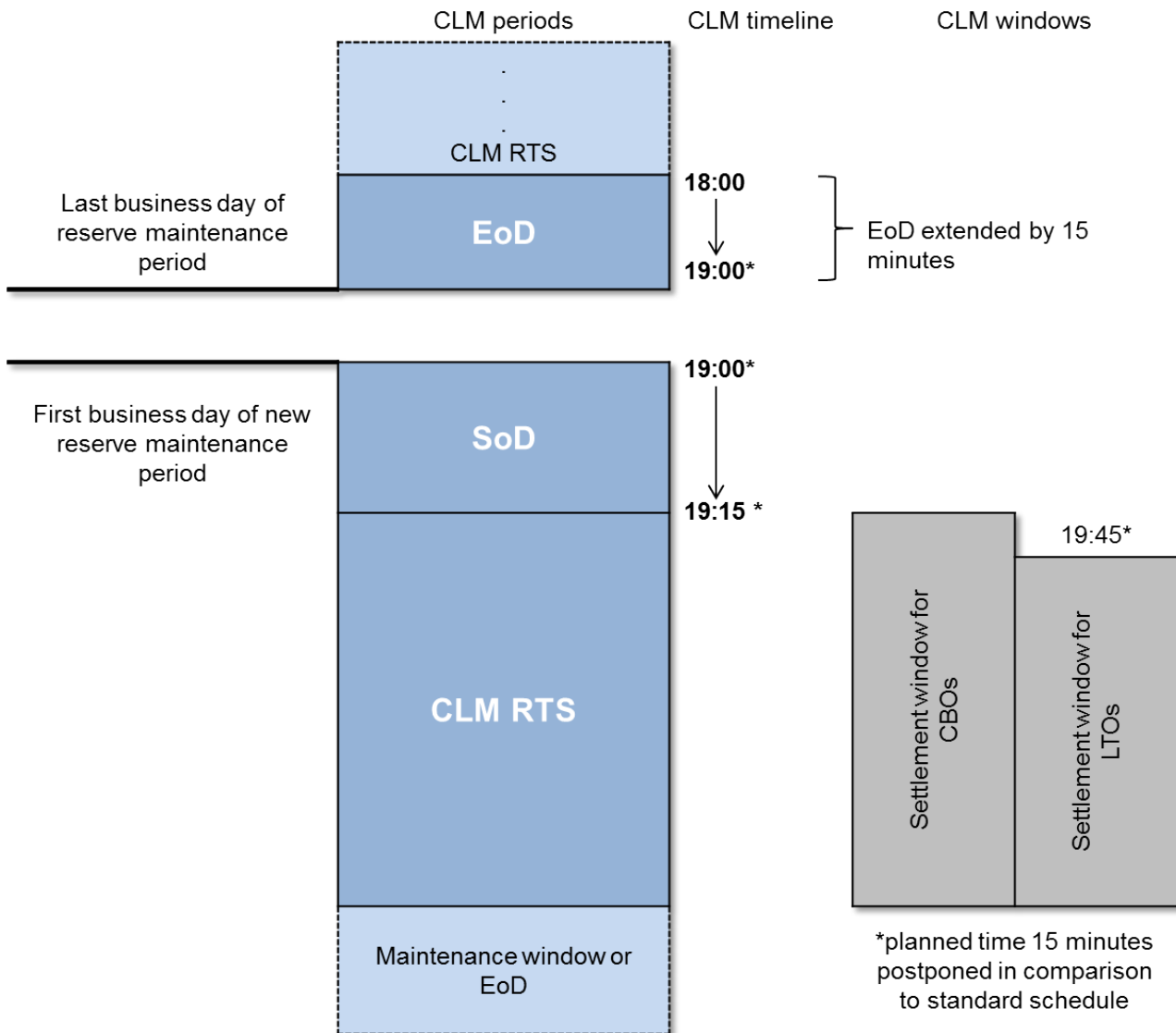

Figure 16 - CLM high-level schedule on the last business day of minimum reserve maintenance period

In order to simplify the reading flow, the following chapter refers to the standard planned times of periods and windows. References to the schedule on the last and first business day of the minimum reserve maintenance period are avoided, as the changes are described in the graph above.

4.4 Detailed description of the business day

This chapter provides a detailed description of all CLM periods of the business day.

4.4.1 Start-of-day period (18:45 - 19:00 CET)

This chapter presents the processes during the SoD.

The SoD starts after the successful completion of the previous EoD period, but not before 18:45 CET. It starts with the event “Change of business day” and ends with the event “Start of CLM RTS”. This period concentrates on the preparation of the new business day. The planned duration of the period is from 18:45 CET until 19:00 CET.

The table below describes the processes executed during SoD:

CLM processes	Events and description of the processes
Change of business day	<p>Event (not time-based):</p> <p>“Change of business day”</p> <p>CLM changes the business date according to the T2 calendar.</p> <p>The new business day schedule is created on the basis of the default schedule of events and its planned times.</p>
Processing of standing order reservations in CLM	<p>CLM executes the standing order reservations for the settlement of CBOs.</p>
Revalidation of warehoused payments	<p>After activating the reference data CLM revalidates the warehoused payments against the reference data valid as of the new business day (Process business day event “Change of business day” [267]).</p> <p>In case the execution date is reached the warehoused payment orders are submitted to CLM settlement process. The following warehoused payment orders generated by CLM are also covered by this process:</p> <ul style="list-style-type: none"> warehoused payment order for interest on minimum reserve fulfilment; warehoused payment order for interest on excess reserve; warehoused payment order for interest for accounts subject to interest calculation; warehoused payment order for accumulated interest on overnight deposits of CLM Account Holders of CBs outside the Eurosystem.

Table 15 - Events and processes during SoD

4.4.2 CLM RTS period (19:00 - 18:00 CET)

This chapter presents the processes during CLM RTS.

The CLM RTS starts after the successful completion of the SoD and with the event “Start of CLM RTS”. It ends with the event “Cut-off for CLM RTS”. The planned duration of the period is from 19:00 CET until 18:00 CET. It contains two settlement windows:

- | settlement window for CBOs;
- | settlement window for liquidity transfer orders.

On business days after T2 closing days, including every business day Monday, CLM RTS is interrupted by the non-optional maintenance window:

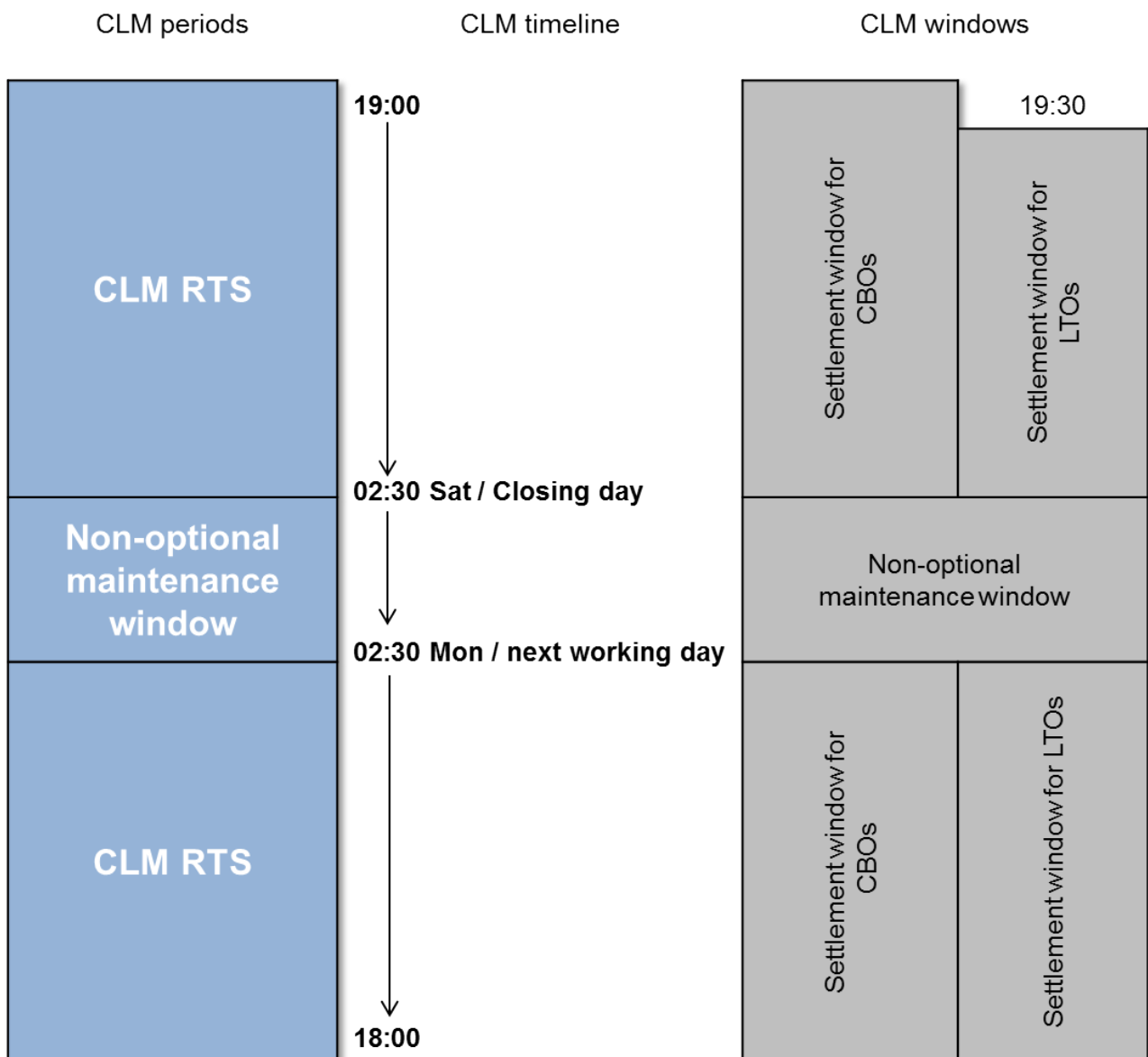

Figure 17 - Settlement windows during CLM RTS with non-optional maintenance window

On every other business day CLM RTS may be interrupted by the optional maintenance window. In case the optional maintenance window is not activated, both settlement windows are open without interruption:

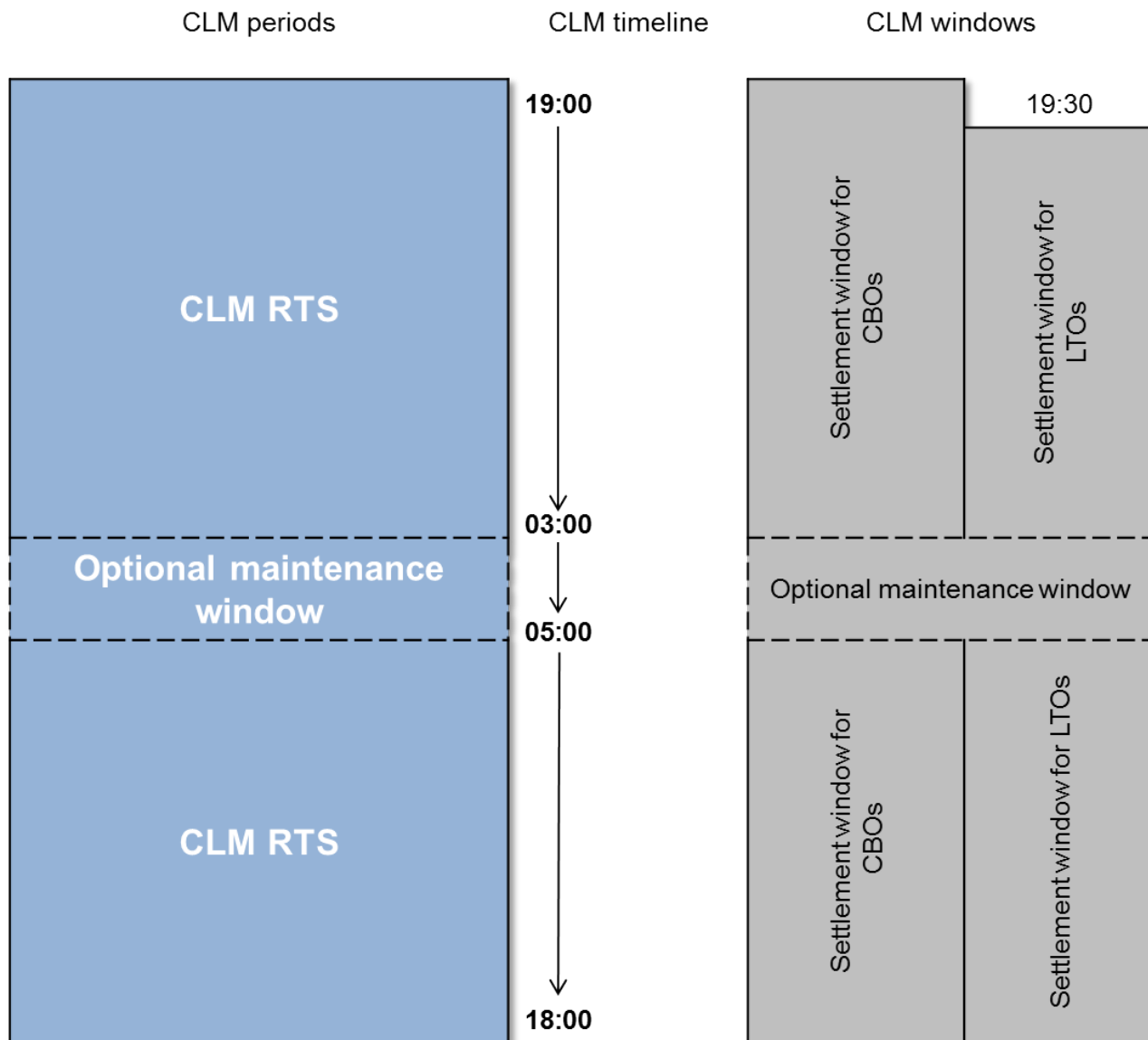

Figure 18 - Settlement windows during CLM RTS with optional maintenance window

4.4.2.1 Settlement window for CBOs

The settlement window for CBOs is started by the event "Start of CLM RTS". The planned time for this event is 19:00 CET. The settlement window is closed by the "Cut-off for CLM RTS".

The table below describes the processes which are automatically executed by CLM at the start of the settlement window:

CLM processes	Events and description of the processes
Opening of settlement window	Event (time-based): “Start of CLM RTS”
Reimbursement of marginal lending	<p>Before ECMS</p> <p>CLM performs the reimbursement of marginal lending amounts and the calculation and posting of interest.</p> <p>(Reimbursement of automatic marginal lending [282]; Reimbursement of marginal lending on request [282])</p> <p>After ECMS</p> <p>CLM performs the reimbursement of automatic marginal lending amounts</p> <p>(Reimbursement of automatic marginal lending [282])</p>
Refunding of overnight deposit	CLM performs the refunding of overnight deposit amounts and the calculation and posting of interest.
Creating of automated liquidity transfers	CLM starts creating automated liquidity transfers to pull missing liquidity from linked RTGS DCAs (linked through the Associated Liquidity Transfer Account Attribute) in case of queued/pending CBOs.
Creating of rule-based liquidity transfers	CLM starts creating rule-based liquidity transfers in case of floor or ceiling breach.

Table 16 - Events and processes at the start of settlement window for CBOs

Besides the above-mentioned processes, the CBs are able to process all types of CBOs during the whole settlement window. Further details including a list of use cases can be found in chapter [Processing of CBOs](#) [▶ 95].

4.4.2.2 Settlement window for liquidity transfer orders

The settlement window for liquidity transfer orders is started by the event “Execution of standing orders in CLM”. The settlement window for liquidity transfer orders is opened earliest 20 minutes after the settlement window for CBOs starts. The planned time for this event is 19:30 CET. The settlement window is closed by the “Cut-off for CLM RTS”.

The table below describes the processes which are automatically executed by CLM at the start of the settlement window:

CLM processes	Events and description of the processes
Opening of settlement window	Event (time-based): "Execution of standing orders in CLM"
Processing of standing order liquidity transfer orders in CLM	CLM processes CLM standing order liquidity transfer orders defined "Execution of standing orders in CLM".
Processing of immediate liquidity transfers	CLM starts general processing of immediate liquidity transfer orders and processes parked immediate liquidity transfer orders which were entered via A2A after CLM business day event "Start of CLM RTS" from CLM Actors. ²²

Table 17 - Events and processes at the start of settlement window for liquidity transfer orders

4.4.2.3 "Cut-off for CLM RTS"

CLM RTS is closed by the event "Cut-off for CLM RTS". The planned time for this event is 18:00 CET. The cut-off implies the closure for:

- I liquidity transfer orders by CLM Actors;
- I CBOs, except standing facilities, connected payments and credit line modifications.

Standing facilities, connected payments and credit line modifications are continued being processed during EoD period until the relevant cut-offs.

The table below describes the processes executed at the cut-off event:

CLM processes	Events and description of processes
Closure of CLM RTS	Event (time-based): "Cut-off for CLM RTS"
Closure for incoming cash transfer orders	New liquidity transfer orders and payment orders by CLM Actors are not accepted after the cut-off and are rejected.

Table 18 - Events and processes at the "Cut-off for CLM RTS"

The table below describes the processes subsequently executed after the cut-off event:

²² When an immediate liquidity transfer order is parked it cannot be revoked.

CLM processes	Events and description of processes
Last execution of standing order liquidity transfer orders in CLM	CLM processes CLM standing order liquidity transfer orders defined for "Cut-off for CLM RTS".
Rejection of not finally processed payment orders	Payment orders with non-final status are rejected.
Rejection of not finally processed task queue orders	Task queue orders with non-final status related to cash transfer orders are rejected.
Rejection of not finally processed reservation modifications	Reservation modifications with non-final status are rejected.

Table 19 - Events and processes after the "Cut-off for CLM RTS"

4.4.3 Maintenance window

System maintenance processes take place in the maintenance window.

During the maintenance window, it is not possible to access:

- | CLM GUI;
- | DWH;
- | reference data.

Files and individual messages received via A2A are parked for processing until the maintenance window is closed and CLM RTS resumes.

Non-optional maintenance window

On all business days after T2 closing days, including every business day Monday a non-optional maintenance window is conducted. The non-optional maintenance window starts with the event "Start of non-optional maintenance window" at a planned time of 02:30 CET on the closing day, e.g. Saturday. In case the option of additional T2S NTS cycles is activated on T2S, the "Start of non-optional maintenance window" can be manually postponed up to 2 hours to 4:30 CET at the latest.²³

The non-optional maintenance window ends with the event "End of non-optional maintenance window" at a planned time of 02:30 on the next working day.

Optional maintenance window

On all other business days the maintenance window is activated on an optional basis. When activated, the optional maintenance window starts with the event "Start of optional maintenance window" at a planned time

²³ The details with regard to such change of the planned start time are defined outside of the detailed functional specification.

of 03:00 CET and ends with the event “End of optional maintenance window” at a planned time of 05:00 CET.

4.4.4 End-of-day period (18:00 - 18:45 CET)

This chapter presents the processes during the EoD.

The EoD period starts after the successful rejection of not finally processed CLM operations. The planned duration of the period is from 18:00 CET until 18:45 CET:

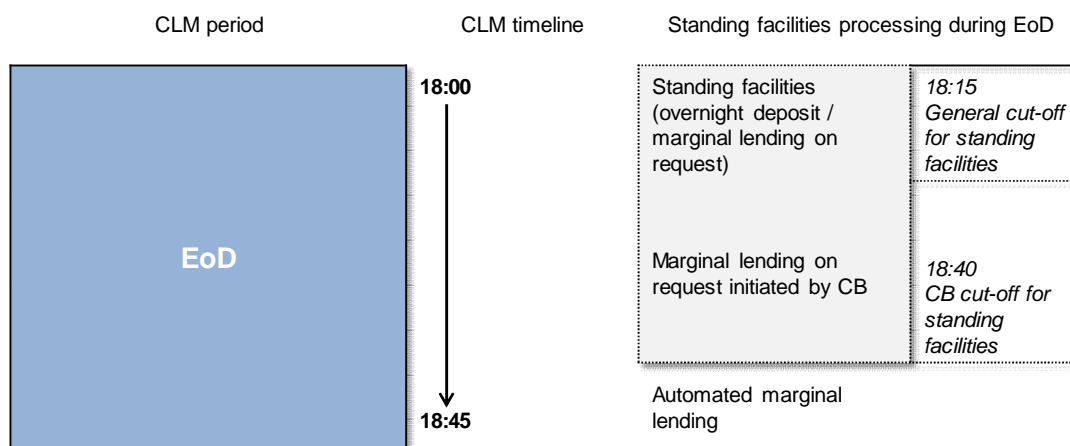

Figure 19 - Standing facilities processing during EoD

“General cut-off for standing facilities”

The use of standing facilities for the CLM Account Holder (marginal lending on request until the launch of ECMS and overnight deposit) is possible until the event “General cut-off for standing facilities”. The planned time for this event is 18:15 CET.

Note: On the last business day of the minimum reserve maintenance period the planned time for this event is 18:30 CET. All subsequent events are postponed by 15 minutes. The business day schedule for the last

day of minimum reserve maintenance period is described in chapter [Overview description of the business day](#) [▶ 76].

Until the launch of ECMS, CBs are able to insert liquidity transfer orders for marginal lending on request after the event “General cut-off for standing facilities”.

“CB cut-off for standing facilities”

Until the launch of ECMS, CBs are able to insert requests for marginal lending until the event “CB cut-off for standing facilities”. The planned time for this event is 18:40 CET. On the last business day of the minimum reserve maintenance period, the planned time is 18:55 CET.

The table below describes the processes executed at EoD:

CLM processes/EoD cut-offs	Events and description of the processes
Start of EoD	Event (not time-based): “Start of EoD processing”
Collection of balances from other settlement services	CLM collects general ledgers containing the account balance information for all cash accounts from other settlement services after it has verified, that all inter-service liquidity transfers are in a final status and performs consistency checks on the provided general ledgers. For detailed information refer to chapter Coordinate general ledger creation with other settlement services [▶ 263]. The completion of the general ledger collection process is no condition for the start of the following period.
Non-CLM settlement services general ledgers delivery	CLM creates and sends a General ledger (camt.053) [▶ 567] for each settlement service (except CLM) and currency to each CB. The general ledger for the respective settlement service is immediately created and sent after it has been received from the settlement service and validated.
Calculation of cross-CB turnover	CLM calculates and settles the cross-CB turnover for: <ul style="list-style-type: none"> CLM as soon as CLM has verified, that all inter-service liquidity transfers are final; each other settlement service after the receipt of the respective general ledger.
“General cut-off for standing facilities”	Event (time-based): “General cut-off for standing facilities” Planned 15 minutes after event “Cut-off for CLM RTS” (+ additional 15 minutes at the last business day of the minimum reserve maintenance period)
Closure for incoming overnight	New overnight deposit orders (setting-up and reverse) by CLM Actors are not

CLM processes/EoD cut-offs	Events and description of the processes
deposit orders	accepted after the cut-off and are rejected.
“CB cut-off for standing facilities“	Event(time-based): “CB cut-off for standing facilities” Planned 40 minutes after “Cut-off for CLM RTS” (+additional 15 minutes at the last business day of the minimum reserve maintenance period)
Closure for incoming marginal lending on request orders and update of credit line	New liquidity transfer orders for marginal lending on request by CBs are not accepted after the cut-off and are rejected. New orders to update credit lines (via A2A, U2A and connected payments) are not accepted after the cut-off and are rejected. After ECMS Payment orders sent by ECMS are not accepted after the cut-off and are rejected. New orders to update credit lines (via A2A, U2A and connected payments) are not accepted after the cut-off and are rejected.
Rejection of not finally processed credit line modifications	Credit line modifications with non-final status and connected payments with status earmarked due to blocking are rejected.
Check of reference data	After propagation of reference data for next business day: Check of cash accounts to be closed as of the next business day with balance and processing of emergency liquidity transfer towards the responsible CB in case of need.
Calculation of aggregated EoD balances for automatic marginal lending	After the event “CB cut-off for standing facilities” CLM calculates the aggregated EoD balance of a CLM Account Holder under consideration of liquidity positions in all settlement services received in the general ledgers.
Automatic marginal lending	The automatic marginal lending is triggered by CLM if the calculated aggregated balance of a CLM Account Holder is negative after the event “CB cut-off for standing facilities” and the CLM Account Holder is allowed to access marginal lending. Otherwise, CLM sends a spillover notification (camt.004 [380]) to the responsible CB.
Minimum reserve processing	CLM calculates the running average and the adjustment balance per leading CLM Account Holder subject to minimum reserve requirements. On the last day of the minimum reserve maintenance period, CLM verifies the minimum reserve fulfilment for each relevant leading CLM Account Holder and creates the respective interest payment orders for: <ul style="list-style-type: none"> minimum reserve fulfilment; excess reserve.

CLM processes/EoD cut-offs	Events and description of the processes
	The interest payment orders are created with execution date two business days after the end of the minimum reserve maintenance period.
Interest calculation for accounts subject to interest calculation	On the last business day of the calculation period, CLM calculates the interest for accounts subject to interest calculation and creates the respective interest payment order. The interest payment orders are created with execution date two business days after the end of the relevant remuneration period.
EoD reporting	CLM creates reports scheduled for EoD.
CLM general ledgers delivery	CLM creates and sends a General ledger (camt.053) [567] for CLM for each currency to each CB. The CLM general ledger is sent after the successful execution of the automatic marginal lending.
Check final status of all business transactions	CLM checks finality of all business transactions before closing the business day.
EoD completed	Event (time-based): "EoD – close of service" Activation of Reference Data for the next business day. This will be visible only after the run of next Start of Day with Business Day event "Change of business day" (CSOD).

Table 20 - Events and processes during EoD

4.4.5 Currency specific closing

On currency specific closing days CLM is closed for the operations in one currency, while operations in another currency are possible. The currency specific closing starts with the event "Start of currency specific closing" at a planned time of 02:30 CET on the currency specific closing day and ends with the event "End of currency specific closing" at a planned time of 02:30 on the next working day for that currency or T2 closing day for all currencies. In the latter case the non-optional maintenance window is applied after the currency specific closing.

Instructions received via A2A in the closed currency are parked for processing until currency specific closing is ended and CLM RTS resumes. However, A2A queries arriving during currency specific closing are rejected.

4.5 List of events

The following table provides a summary of all events in the CLM business day. Furthermore it indicates:

- | the CLM code for all events;
- | which events are time-based, i.e. for which event a time can be set;
- | **Note:** Events marked with not time-based depend on the previous time-based event.
- | for which events standing orders can be configured in CLM;
- | at which events a business day notification ([ReturnBusinessDayInformation \(camt.019\)](#) [▶ 469]) is pushed by CLM, if subscribed;
- | which events are currency-specific.

Note: The sequence of the listed events cannot be changed.

Some currency-specific events can be moved to an:

- | earlier time only than for Euro currency but not to a later time (see footnotes);
- | later time only than for Euro currency but not to an earlier time (see footnotes).

Period	Event	Code	Time-based	Standing order	Push ReturnBusinessDayInformation (camt.019)	Multi-currency
SoD	“Change of business day”	CSOD	Yes	No	Yes	Not currency-specific
CLM RTS	“Start of CLM RTS”	CRTI	Yes	No	Yes	Currency-specific ²⁴
	“Execution of standing orders in CLM”	CESO	Yes	Yes	Yes	Currency-specific
	“Cut-off for CLM RTS”	CCII	Yes	Yes	Yes	Currency-specific ²⁵
	“Data propagation for T2 (CLM and RTGS)”	T2D2	No	No	No	Not currency-specific
Maintenance window	“Start of non-optional maintenance window”	CSMW	Yes	No	Yes	Not currency-specific

24 This currency-specific event can be defined later for other currencies than for Euro currency but not earlier, i.e after 19:00 CET.

25 This currency-specific event can be defined earlier for other currencies than for Euro currency but not later, i.e before 18:00 CET.

Period	Event	Code	Time-based	Standing order	Push Return Business Day Information (camt.019)	Multi-currency
	“End of non-optional maintenance window”	CEMW	Yes	No	Yes	Not currency-specific
	“Start of optional maintenance window”	CSOM	Yes	No	Yes	Not currency-specific
	“End of optional maintenance window”	CEOM	Yes	No	Yes	Not currency-specific
EoD	“Start of EoD processing”	CEOD	No	No	No	Currency-specific ²⁶
	“General cut-off for standing facilities”	CCSF	Yes	No	No	Currency-specific ²⁷
	“CB cut-off for standing facilities”	CCML	Yes	No	No	Currency-specific ²⁸
	“EoD – close of service”	CCOS	No	No	No	Not currency-specific
Currency specific closing	“Start of currency specific closing”	CSCC	Yes	No	Yes	Currency-specific
	“End of currency specific closing”	CECC	Yes	No	Yes	Currency-specific

Table 21 - List of events

26 Depends on previous time-based currency-specific event.

27 This currency specific event will trigger no processes for non-Euro currency. This currency-specific event can be defined earlier for other currencies than for Euro currency but not later.

28 This currency-specific event can be defined earlier for other currencies than for Euro currency but not later.

5 Business and features description

5.1 File and message processing

5.1.1 Overview

CLM processes both inbound files and inbound messages.

A file is a communication that is identified by a [Business File Header \(head.002\)](#) [▶ 555] and contains one or many individual messages. A technical wrapper (head.003) for each message identifies the individual message in the file. When CLM receives a file, it splits the file into individual messages and submits each message to the same message processing that CLM uses when receiving individual messages from submitting actors.

The file can contain different kind of instructions (e.g. payment orders, amendments of payment order, liquidity transfer orders etc.), but all contained instructions have to be directed to CLM only and must not be mixed with instructions to other components (e.g. CRDM or RTGS). Furthermore, apart from instructions to CLM no other types of requests are allowed to be sent in a file (e.g. queries).

A message is a data structure for the submission of business data that consists of a [Business Application Header \(BAH\)](#) [▶ 549] and a business payload. The BAH provides for all types of messages consistently in one structure data about the message, such as which organisation has sent the message, which organisation should be receiving it, the identity of the message itself, a reference for the message and other information that is common to all messages and the business application. The business payload contains the business data that the submitting actor wants to be processed in CLM or to be received from CLM.

Files and messages that CLM receives from submitting actors are subject to validation checks ensuring that the requirements for processing and settlement have been fulfilled. The validation process can be broken down into two steps: a technical validation and a business validation. Chapter [Description](#) [▶ 209] provides further information on the processing of inbound files.

5.1.2 Technical validation

CLM performs a technical validation that verifies the compliance of an inbound file or message with the defined schema of the respective file or message. The technical validation checks:

- | syntax, format and structure;
- | whether mandatory fields are populated;
- | the BAH for messages;
- | the BFH and the technical wrapper for files.

CLM performs the technical validation to the extent possible in order to report the maximum number of identifiable errors. CLM sends a negative [ReceiptAcknowledgement \(admi.007\)](#) [▶ 370] that reports the error(s) to the submitting actor when the technical validation fails. Chapter [Index of validation rules and error codes](#) [▶ 643] provides further information on the business rules and the respective error codes for files and messages.

5.1.3 Business validation

The business validation is the process ensuring that the information in a message is correct for further processing.

CLM validates the business data in an inbound file or message against the defined business rules for the file or message and its usage. CLM does not terminate the business validation after identifying the first error, but continues to perform the business validation to the extent possible in order to report the maximum number of identifiable errors. Consequently, the rejection notification that CLM sends for the failed business validation of a file or a message may include several error codes in order to report the outcome of multiple failed business validations. Chapter [Index of validation rules and error codes](#) [▶ 643] provides further information on the business rules and the respective error codes for files and messages.

5.2 Cash transfer orders and cash transfers in CLM

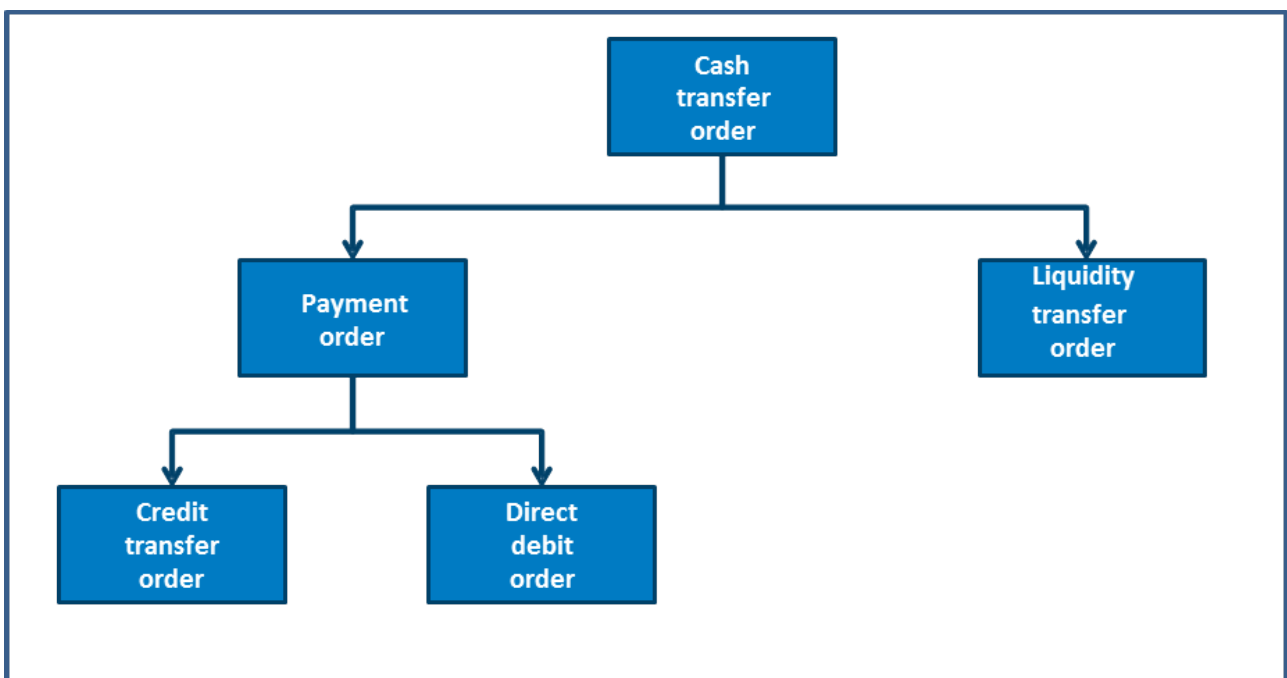

Figure 20 - CLM cash transfer order classification

CLM distinguishes between different types of cash transfer orders and cash transfers.

- | The term cash transfer order encompasses payment orders and liquidity transfer orders. A cash transfer is a settled cash transfer order.
- | A payment order is a term that encompasses both a credit transfer order and a direct debit order. A payment is a settled payment order.
- | A credit transfer order is an instruction from the payer to credit a specific amount of funds on the payee's cash account. A credit transfer is a settled credit transfer order.
- | A direct debit order is a pre-authorised instruction from the payee to debit a specific amount of funds on the payer's CLM MCA/CB Account. A direct debit is a settled direct debit order.
- | A liquidity transfer order is an instruction to transfer a specific amount of funds between two cash accounts. A liquidity transfer is a settled liquidity transfer order.

CLM requires the use of ISO 20022 messages to instruct cash transfer orders for processing in CLM via A2A. An important difference between a payment and a liquidity transfer is the mandatory provision of a UETR reference in a payment. Alternatively, some cash transfer orders can also be instructed via U2A/GUI. In the case of U2A payments the UETR reference is generated by CLM. CLM also allows to provide a UETR in U2A on optional basis taking into account a possible erroneous input – e.g. the duplicate check. The UETR has a special format. Thus it is only accepted, if the correct format is used. The following cash transfer order types can be used:

Cash transfer order	Message Identifier	Message Name
Credit transfer order for an interbank payment	pacs.009 [▶ 624]	FinancialInstitutionCreditTransfer [▶ 624]
Direct debit order for an interbank payment	pacs.010 [▶ 633]	FinancialInstitutionDirectDebit [▶ 633]
Liquidity transfer order	camt.050 [▶ 505]	LiquidityCreditTransfer [▶ 505]

Table 22 - Cash transfer order types in CLM

5.3 Cash transfer order processing

5.3.1 Processing of CBOs

In principle, in CLM the following CBOs are processed and settled on the MCAs of the CLM Account Holder:

- | update of credit line (cash side);
- | marginal lending and overnight deposits (summarised as standing facilities²⁹);
- | cash withdrawals and cash lodgements;

29 Setting up and reverse transaction of overnight deposit are activities which can be carried out by the CLM Account Holder itself.

- | monetary policy operations other than standing facilities (e.g. open market operations like the main refinancing operation or the longer-term refinancing operations);
- | debit of the invoiced amount;
- | interest payment orders linked to marginal lending, overnight deposits, minimum reserves, excess reserves and for accounts subject to other purposes of interest calculation;
- | any other activity carried out by CBs in their capacity as CB of issue.

Within the CLM UDFS the term CBO covers one out of the above-mentioned operations. CBOs can be initiated using [FinancialInstitutionCreditTransfer \(pacs.009\)](#) [▶ 624] and [LiquidityCreditTransfer \(camt.050\)](#) [▶ 505] via A2A or via U2A. Direct debits can be initiated by A2A only. Details on using U2A mode are provided in the CLM UHB. Payment orders can only be sent by actors of the party type CB. Liquidity transfer orders can be sent by all actors which have the necessary privileges. CBOs like interest payments, automatic marginal lending –set-up, overnight deposit refunds and reimbursements of marginal lending are triggered automatically in CLM.

Thus CBOs are categorised as follows:

CBO type	Initiation via	Message
Update of credit line	A2A or U2A as task queue order	camt.998 - ModifyCreditLine [▶ 580]
	Connected payment ³⁰ (in case of direct debit A2A only)	pacs.009 - FinancialInstitutionCreditTransfer [▶ 624]
		pacs.010 - FinancialInstitutionDirectDebit [▶ 633]
Standing facility orders for:	Liquidity transfer order	camt.050 - LiquidityCreditTransfer [▶ 505]
<ul style="list-style-type: none"> marginal lending on request – setting up order³¹; overnight deposits – setting up order; overnight deposits – reverse order. 		
Linked to standing facilities:	Triggered automatically	-
<ul style="list-style-type: none"> setting up of automatic marginal lending; marginal lending reimbursement³²; 		

30 After ECMS go-live, local CMS will no longer exist for EUR and therefore there is no longer a business case for connected payments to update the credit line by CBs.

31 Until ECMS go-live. After ECMS go-live the process will be performed by a connected payment or a regular payment.

CBO type	Initiation via	Message
<ul style="list-style-type: none"> overnight deposit refund. 		
Debit of the invoiced amount	Payment order with direct debit order for an interbank payment (A2A only)	pacs.010 - FinancialInstitutionDirectDebit [633]
Payment orders for: <ul style="list-style-type: none"> cash withdrawals and lodgements³³; monetary policy operations other than standing facilities including repay³⁴; any other activity carried out by CBs in their capacity as CB of issue. 	Payment order with credit transfer order for an interbank payment Payment order with direct debit order for an interbank payment (A2A only)	pacs.009 - FinancialInstitutionCreditTransfer [▶ 624] pacs.010 - FinancialInstitutionDirectDebit [633]
Regular payment orders for interest payment orders linked to: <ul style="list-style-type: none"> marginal lending (until go-live of the ECMS); overnight deposits; minimum reserves; excess reserve – Tier 1 excess reserve – Tier 2 accounts subject to other purposes of interest calculation. 	Triggered automatically	-

Table 23 - CBOs in CLM

Further details are provided in the chapters [Flow of payment orders](#) [▶ 100] and [Processes with CLM](#) [▶ 207].

Note: In case the CB sends a direct debit order to credit its CLM CB Account, in general no direct debit mandate is needed. Only in case the CB submits a direct debit order posted on an MCA of a CLM Account Holder not belonging to “its” own banking community, a direct debit mandate is needed.

When submitting a payment order, a CB has the possibility to define an execution time (see chapter [Definition of execution time](#) [▶ 98]).

32 Reimbursement of the capital amount for marginal lending on request only until ECMS go-live.

33 For cash withdrawals and lodgements, also a [camt.050](#) [▶ 503] may be used instead of a [pacs.010](#) [▶ 631] or [pacs.009](#) [▶ 622]. However, only using the [pacs.010](#) [▶ 631] or [pacs.009](#) [▶ 622] will provide the full range of functionalities; in a [camt.050](#) [▶ 503] no dedicated payment type proprietary code information or other remittance information is possible and thereby the CBO reservation in CLM cannot be used.

34 Until ECMS go-live. After ECMS go-live those processes will be performed by a connected payment or a regular payment.

Furthermore, payment orders can be submitted as “warehoused payment orders” which means that the payment order related to a CBO is sent up to ten calendar days in advance (Table 14 - [Attributes of the warehoused payment period](#) [▶ 71]). In this case, the payment order is warehoused until CLM opens for settlement on the intended business day on which the warehoused payment order shall be settled.

A CB can send payment orders (i.e. credit transfer orders and/or direct debit orders) either as regular payments or as connected payments. Connected payments are payment orders sent by a CB to a CLM Account Holder that trigger at the same time a change in the credit line of the MCA of the CLM Account Holder and an immediate debit/credit on this MCA. Due to the link between a payment (an immediate debit/credit of its MCA) and a corresponding change of credit line, they are called connected payments. Connected payments can be used for the settlement of monetary policy operations or for changing the credit line on an MCA. In case of a “pure” credit line change, the amount indicated in the connected payment is zero. Further details are provided in chapter [Connected payment](#) [▶ 191].

Overnight deposits are initiated via liquidity transfer orders ([LiquidityCreditTransfer \(camt.050\)](#) [▶ 505]). Apart from the special case referred to in the footnote on cash withdrawals, only these CBOs can be instructed by CLM Account Holders in CLM.

Consequently, besides submitting inter-service and intra-service liquidity transfer orders, a payment bank eligible for overnight deposits (or another actor which has the appropriate access rights, e.g. a co-manager) can submit a liquidity transfer order to set up or reverse an overnight deposit (i.e. a CBO).

Further details can be found in chapter [Process overnight deposit - setting up order](#) [▶ 275] and [Process overnight deposit - reverse order](#) [▶ 275].

5.3.2 Definition of execution time

The above-mentioned CBOs can be processed throughout the relevant settlement windows. Further details on the business day and the cut-offs applicable are provided in chapter [Business day](#) [▶ 73].

In case of payment orders, CBs have the possibility to determine the settlement time of their payment orders. The following options are available:

- | an “earliest debit time indicator” (FromTime);
- | a “latest debit time indicator” (RejectTime).

The following table describes the effect and the processing of payment orders with a set execution time:

	Earliest debit time indicator	Latest debit time indicator
Features	Payment order to be executed from a certain time on (message element: FromTime)	Specifies that a payment order must settle by the defined time (message element: RejectTime)
Effect	Payment order is stored until the indicated time (with status earmarked). At the earliest debit time, the payment order runs through the entry disposition [107].	In case a RejectTime is indicated, the payment order is rejected, if it could not be settled until the latest debit time.
Processing	<ul style="list-style-type: none"> CLM submits the payment order for settlement when the earliest debit time as specified in the payment order is reached. If CLM cannot settle the payment order immediately, CLM places the payment order in the payment order queue with status "queued". If the payment order does not settle by the end of the settlement window for the respective payment order type or by the reject time - as specified in the payment order - is reached, then CLM rejects the payment order. 	If the payment order with the RejectTime indicator cannot be settled until the indicated debit time, CLM rejects the payment order and sends a rejection notification [▶ 239]. Further details are provided in chapter Process CLM reject time [▶ 239].

Table 24 - Payment orders with set execution time indicators

In case a payment order with a "latest debit time indicator" (i.e. RejectTime) is not executed 15 minutes prior to the defined time, an automated broadcast via U2A is triggered.

An A2A broadcast is sent via [SystemEventNotification \(admi.004\)](#) [▶ 365] in addition to the U2A broadcast in case the respective party has subscribed to receiving A2A broadcasts.

Such a broadcast is sent to the CLM Account Holder or CLM CB Account Holder to be debited. Further details on broadcasts are provided in chapters [Broadcasts](#) [▶ 168] and [Initiate CLM reject time broadcast](#) [▶ 240].

It is possible to combine the "earliest debit time indicator" with the "latest debit time indicator". The payment order is meant to be executed during the indicated period.

The defined execution time of a payment order can be changed if the payment order is not executed yet. For the effect of changing the settlement time, see chapter [Modification of payment orders](#) [▶ 105] as well as chapter [Comprehensive queue management](#) [▶ 114].

Note: It is not possible to change the "earliest debit time indicator" of a payment order which is queued due to the fact that the original "earliest debit time indicator" was reached and CLM already tried to settle this payment order.

5.3.3 Warehoused payment orders

Basics

A warehoused payment order is a payment order that a CB submits up to ten calendar days in advance of the date on which the payment order is to be executed. Warehoused payment orders are stored in CLM with the payment order status “warehoused”. They are validated every day between submission day and the intended settlement day. The validation process takes place during the SoD.

CLM revalidates warehoused payment orders during the start of every business day to ensure that they remain compliant with all business validation rules taking into account the relevant reference data changes. If the payment order fails revalidation, then CLM rejects the payment order.

Note: In case a change of the schemas is necessary due to a scheduled release, warehoused payment orders with an intended settlement date beyond the release implementation date are not accepted. There is an error handling in this case, including the provision of an error code.

Processing on the intended settlement day

On the intended settlement day with the start of the settlement window for the respective payment order type (i.e. credit transfer orders and direct debit orders), the warehoused payment orders are processed. The timestamp is set when the business validations are performed. During each revalidation process the timestamp is adapted. Further details on the business day are provided in chapter [Business day](#) [▶ 73].

Exception: Warehoused payment orders including an earliest debit time indicator (FromTime) which has not been reached yet are set to status “earmarked”.

5.3.4 Flow of payment orders

5.3.4.1 Payment orders initiated by CBs - credit transfer order

Only CBs can send a credit transfer order (i.e. [FinancialInstitutionCreditTransfer \(pacs.009\)](#) [▶ 624]) to a CLM (CB) Account Holder.

In case the technical and business validation is passed successfully, the payment order is submitted to the settlement process. In the following figure the generic flow of messages is described. Further details on the processing of CLM payment orders are provided in chapter [Process CLM payment order and liquidity transfer order](#) [▶ 213].

Message flow

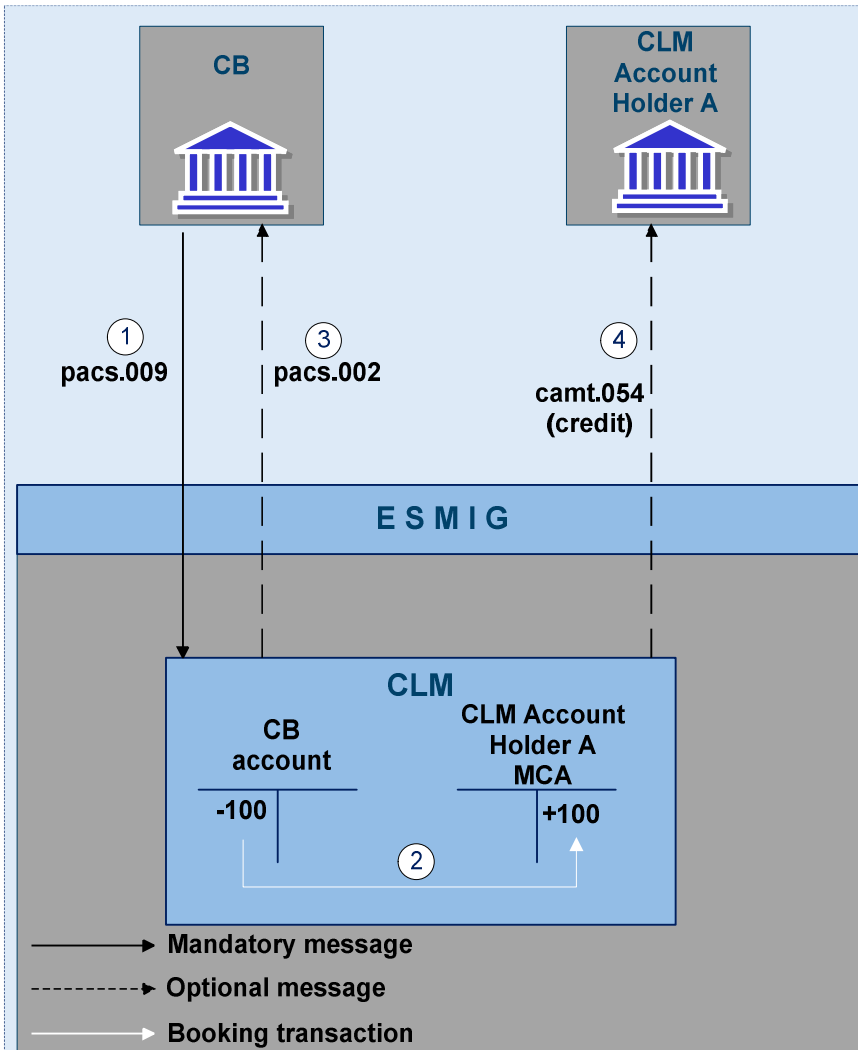

Figure 21 - pacs.009 sent by a CB

Process description

Step	Processing in/between	Description
1	CB via ESMIG to CLM	The CB sends a FinancialInstitutionCreditTransfer (pacs.009) [▶ 624] via ESMIG to CLM.
2	CLM	Settlement takes place in CLM if the CLM message check and validations are positive.
3	CLM via ESMIG to CB	CLM creates and forwards PaymentStatusReport (pacs.002) [▶ 615] via ESMIG to CB (optional).
4	CLM via ESMIG to CLM Account Holder	CLM creates and forwards a BankToCustomerDebitCreditNotification (camt.054) [▶ 520] (credit) via ESMIG to CLM Account Holder A (optional).

Table 25 - CB credit transfer order (technical and business validations passed)

Used messages

- | [FinancialInstitutionCreditTransfer \(pacs.009\) \[▶ 624\]](#)
- | [BankToCustomerDebitCreditNotification \(camt.054\) \[▶ 520\]](#)
- | [PaymentStatusReport \(pacs.002\) \[▶ 615\]](#)

5.3.4.2 Payment orders initiated by CB - direct debit order

Only a CB can send a direct debit order (i.e. [FinancialInstitutionDirectDebit \(pacs.010\) \[▶ 633\]](#)) on the MCA of a CLM Account Holder. CBs are allowed to send direct debits within its community by default. No direct debit mandate is required in CRDM in such a case.

In case the technical and business validations are successfully passed, the payment order is submitted to the settlement process. In the following figure the generic flow of messages is described. Further details on the processing of CLM payment orders are provided in chapter [Process CLM payment order and liquidity transfer order \[▶ 213\]](#).

Message flow

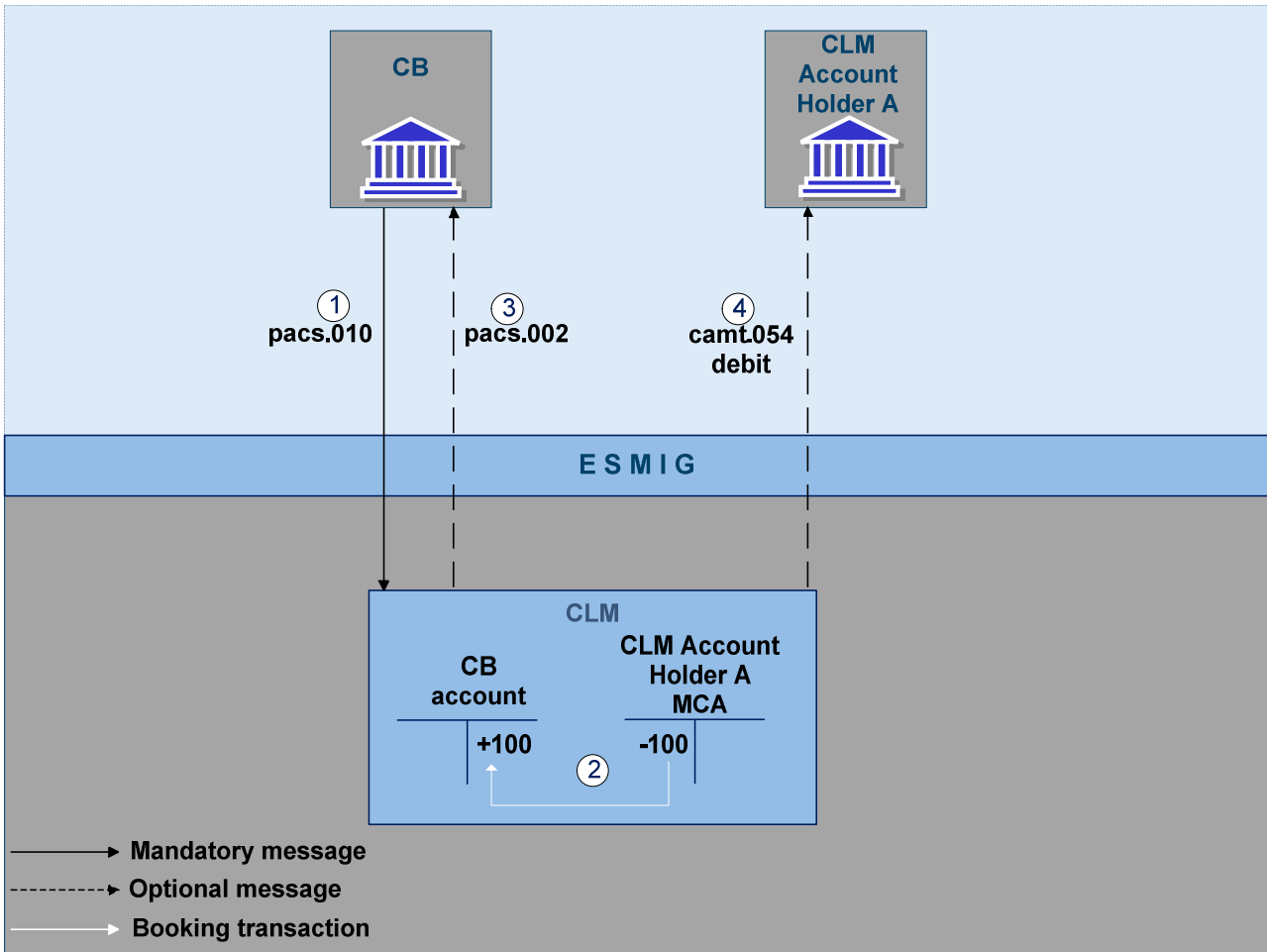

Figure 22 - pacs.010 sent by a CB

Process description

Step	Processing in/between	Description
1	CB via ESMIG to CLM	The CB sends a FinancialInstitutionDirectDebit (pacs.010) [▶ 633] via ESMIG to CLM.
2	CLM	Settlement takes place in CLM if the CLM message check and validations are positive.
3	CLM via ESMIG to CB	CLM creates and forwards a PaymentStatusReport (pacs.002) [▶ 615] via ESMIG to CB (optional).
4	CLM via ESMIG to CLM Account Holder	CLM creates and forwards a BankToCustomerDebitCreditNotification (camt.054) [▶ 520] (debit) via ESMIG to CLM Account Holder A (optional).

Table 26 - CB direct debit order (technical and business validations passed)

Used messages

- | [FinancialInstitutionDirectDebit \(pacs.010\)](#) [▶ 633]
- | [BankToCustomerDebitCreditNotification \(camt.054\)](#) [▶ 520]
- | [PaymentStatusReport \(pacs.002\)](#) [▶ 615]

5.3.5 Rejection of cash transfer orders

The term “rejection” refers to the rejection of a cash transfer order by CLM. CLM rejects a cash transfer order for different reasons.

- | In case the technical validation in CLM fails, CLM creates and forwards a [rejection notification](#) [▶ 211] ([ReceiptAcknowledgement \(admi.007\)](#) [▶ 370]) to the submitting actor of the payment order.
- | In case the business validation in CLM fails, CLM creates and forwards:
 - A [rejection notification](#) [▶ 213] ([PaymentStatusReport \(pacs.002\)](#) [▶ 615]) to the submitting actor of the payment order. The [PaymentStatusReport \(pacs.002\)](#) [▶ 615] refers to the original instruction by means of references and a set of elements from the original instruction.
 - A [rejection notification](#) [▶ 213] ([Receipt \(camt.025\)](#) [▶ 479]) to the submitting actor of the liquidity transfer order not yet settled.
- | In case a rejection time is defined in the payment order and the rejection time is reached, CLM creates and forwards a [rejection notification](#) [▶ 259] ([PaymentStatusReport \(pacs.002\)](#) [▶ 615]) to the submitting actor of the payment order not yet settled.
Note: 15 minutes prior to the rejection time, an automated broadcast is triggered via U2A and shown on the GUI screen. An A2A broadcast ([SystemEventNotification \(admi.004\)](#) [▶ 365]) is sent in addition in case the respective actor has subscribed to receiving the A2A broadcast.
- | Connected payments which cannot be settled are immediately rejected. CLM creates and forwards a [rejection notification](#) [▶ 243] ([PaymentStatusReport \(pacs.002\)](#) [▶ 615]) to the submitting actor.
- | Once the end of the settlement window for payment orders is reached, CLM creates and forwards a [rejection notification](#) [▶ 259] ([PaymentStatusReport \(pacs.002\)](#) [▶ 615]) to the submitting actor of the payment order not yet settled.

CLM always sends negative notifications in case of a rejection, as they are mandatory and not subject to a message subscription.

Further details on the processing in case a cash transfer order is rejected are provided in chapters [Process CLM reject time](#) [▶ 239] and [Reject payment order](#) [▶ 259].

Further details on the handling of payment orders initiated in U2A can be found in the CLM UHB, chapter "[Validations](#)".

5.3.6 Modification of payment orders

As long as a payment order is not in a final status (including warehoused payment orders), the CB has the ability to change certain parameters of this payment order.

The modification of payment orders is possible throughout the whole business day with certain exceptions (e.g. maintenance window). Further details on the business day are provided in chapter [Business day](#) [▶ 73].

The modification of payment orders can be done in U2A only.

In case a CB wants to modify a payment order not yet settled, CLM checks the status of the payment order the modification request is referring to. The payment order to be modified has to be in an intermediate (i.e. not final) status to be eligible for modification. Even in case the modification has not yet been executed, further modifications of the same task type (re-ordering of queued transactions, change of the execution time) can be entered in U2A and will be processed successively.

If a modification is possible, CLM will modify the payment order according to the modification request.

The following different types of modifications are possible in CLM:

Parameter/action	Actor
Re-ordering within the respective queue (increase/decrease position)	CB of the owner of the debited account
Change of set execution time (if defined before sending the payment order to CLM)	CB of the business sender

Table 27 - Possible modification types in CLM

These features enable a CB to react on changed conditions during the day.

As modifications are possible in U2A only, further details are provided in the CLM UHB, chapter "*Modify cash transfer order*".

As a consequence of a modification, the dissolution of the payment order queue process might start. For further details refer to chapter [Dissolution of the payment queue](#) [▶ 116].

Type 1: re-ordering the queued transactions

A CB can change the queue position of payment orders in the queue. The selected payment order can be moved:

- | to the top of the queue;
- | to the end of the queue.

A detailed description of the process and the effect of the re-ordering can be found in chapter [Comprehensive queue management](#) [▶ 114].

Type 2: changing the execution time

Payment orders can include a time that indicates as of when and/or by when they should be settled, i.e. the time of the first settlement attempt (payment orders with an “earliest debit time indicator”) and/or a time after which no further settlement attempt shall take place (payment orders with a “latest debit time indicator”).

The execution time can be changed in CLM via U2A (i.e. the time may be advanced or postponed) as long as the execution time is not reached.

Note: This is only possible in case an execution time has been set in the original payment order. It is not possible to change the originally instructed settlement date via this functionality. For this purpose, the payment order needs to be revoked and a new one needs to be sent with the new settlement date.

A detailed description of the process and the effect of the changed execution time can be found in chapter [Comprehensive queue management](#) [▶ 114].

5.3.7 Revocation of payment orders

As long as a payment order is not settled (including warehoused payment orders), a CB has the ability to revoke this payment order.

The revocation of a payment order is possible throughout the whole business day with certain exceptions (e.g. [maintenance window period](#) [▶ 86]). CBs can initiate a revocation in A2A as well as in U2A mode. A description of the U2A process can be found in the CLM UHB, chapter "*Revocation of payment*".

A revocation request can be sent for credit transfer orders ([FinancialInstitutionCreditTransfer \(pacs.009\)](#) [▶ 624]) as well as for direct debit orders ([FinancialInstitutionDirectDebit \(pacs.010\)](#) [▶ 633]) not yet settled. For the revocation of a payment order not yet settled, the CB needs to send a dedicated revocation request ([FIToFIPaymentCancellationRequest \(camt.056\)](#) [▶ 573]).

In case of a valid revocation request, CLM checks the status of the payment order the revocation is referring to. The payment order to be revoked has to be in an intermediate (i.e. not final) status to be eligible for revocation. If the revocation operation succeeds, CLM revokes the payment order and sends a revocation execution notification as well as a payment order revocation notification to the CB as submitting actor. When the revocation operation fails, a revocation rejection notification with appropriate reason code is sent to the CB ([Index of validation rules and error codes](#) [▶ 643]). Further details are provided in chapter [Perform CLM payment order revocation](#) [▶ 216]. For information on the matching elements between the revocation message and the message of the payment order to be revoked, see [chapter Message References](#) [▶ 331].

5.3.8 Processing of cash transfer orders

5.3.8.1 Effective settlement/execution order

All cash transfer orders and liquidity-related tasks (reservation and orders to change the credit line) have the same priority by default. Nevertheless, in CLM it is acknowledged that the cash transfer orders and liquidity-related tasks serve different business needs. This requires a further categorisation within the same settlement priority, e.g. credit line decrease vs. liquidity transfer. The following table illustrates the effective settlement/execution order for debits on MCAs and the execution of liquidity-related tasks decreasing the available liquidity on the MCA depending on the triggering business in CLM:

Effective settlement/execution order	Business case
1	Credit line decrease and connected payment
2	Seizure of funds reservation increase
3	CBO reservation increase
4	Other CBO (including cash withdrawal and cash lodgement)
5	Liquidity transfer

Table 28 - Effective settlement/execution order for debits and liquidity-related tasks decreasing the available liquidity on the MCA

In case of incoming liquidity a pending CBO reservation increase is executed prior to a queued CBO.

5.3.8.2 Entry disposition

General remarks

In CLM, the available liquidity of the MCA can be divided into a non-reserved part and a part reserved for cash transfer orders related to CBOs as well as orders to decrease the credit line (see chapter [Available liquidity](#) [▶ 118]).

Cash transfer orders related to CBOs use the available liquidity in the reserved part for CBOs of the MCA first. Only in case this reserved part for CBOs does not include any (or not enough) liquidity, the liquidity on the non-reserved part of the available liquidity on the MCA is used in a second step. Moreover, the FIFO-principle applies among all CBOs (i.e. cash transfer orders as well as credit line changes). In case of payment orders, a CB can send credit transfers and/or direct debits either as regular payments or as connected payments.

Inter-service as well as intra-service **liquidity transfer orders** sent by CLM Account Holders can settle only if the liquidity in the non-reserved part of the respective MCA is sufficient. Liquidity transfer orders are settled immediately. Standing order liquidity transfer orders are treated like immediate liquidity transfer orders as soon as the triggering event occurs. The only difference is that standing order liquidity transfer orders can settle partially in case of insufficient liquidity in the non-reserved part of the MCA.

Offsetting mechanisms are not available in CLM.

Basics

The efficient management of liquidity and the settlement of payment orders and liquidity transfer orders in an optimised way are of key importance. Therefore, offering liquidity management features helps fulfilling the objectives of CLM.

These features may, i.e.:

- | result in faster settlement with a reduced amount of liquidity;
- | increase transparency for account holders in CLM;
- | contribute to achieving a higher degree of efficiency;
- | allow for achieving a flexible and need-based control of payment order flows.

Objective for settlement

The aim of the processing in CLM is the fast settlement of cash transfer orders with the following characteristics:

- | settlement in central bank money;
- | immediate, irrevocable settlement of cash transfer orders.

Moreover, it is the aim of the CLM processing to enable an efficient allocation of liquidity among the various settlement services and its fast, immediate and irrevocable settlement.

Influencing factors for the settlement order

The effective processing of cash transfer orders in CLM is inter alia influenced by the following factors:

- | available liquidity (see chapter [Available liquidity](#) [▶ 118]):
 - balance on the MCA;
 - credit line connected to the MCA (will decrease first for settling CBOs with a reservation);
 - seizure of funds, if applicable (a blocked amount would not be available for the settlement of cash transfer orders or credit line modifications);
- | reservation for CBOs, if applicable, induce preferential treatment of CBOs in the settlement order (In case the liquidity on the MCA is not sufficient and CBOs are queued/pending, CLM pulls liquidity from the linked RTGS DCA (linked through the Associated Liquidity Transfer Account attribute) via an automated liquidity transfer order.);

- | sequence of cash transfer orders (including CBOs and liquidity transfers) submitted (according to the FIFO-principle);
- | set execution time (such payment orders are settled only after an “earliest debit time indicator” (FromTime) and/or before a “latest debit time indicator (RejectTime)).

An overview of the effects of liquidity tapping on the settlement order can be found in chapter [Effect and tapping of liquidity reservation](#) [▶ 132].

Basic principles

A payment bank can send liquidity transfer orders:

- | as inter-service liquidity transfer orders;
- | as intra-service liquidity transfer orders;
- | related to overnight deposits.

A CB can send:

- | liquidity transfer orders;
- | payment orders related to CBOs either as:
 - regular payments;
 - connected payments.

Connected payments are payment orders that trigger at the same time a change in the credit line of the MCA of the CLM Account Holder and an immediate debit/credit on this MCA. Due to the link between a payment (an immediate debit/credit on the MCA) and a corresponding change of the credit line, they are called connected payments. Contrary to regular payments, connected payments are not queued in case a settlement attempt was unsuccessful.

The following principles apply to the processing of cash transfers in CLM.

- | All cash transfer orders have the same priority.
- | CLM attempts to settle a cash transfer order immediately after its submission - with the exception of payment orders with a set earliest debit time indicator “FromTime”. In case a “FromTime” is defined, these payment orders are included in the settlement process only from the time indicated as earliest debit time.
- | A payment order can include the latest debit indicator “RejectTime”. In case a “RejectTime” is defined, the CBOs are excluded from the settlement process and are rejected at that time indicated at the latest (if not settled before).
- | Warehoused payment orders can be initiated by default up to ten calendar days prior to the intended settlement date³⁵. After successful validation, the payment order is warehoused until the SoD of the intended settlement date.

³⁵ The number of days is defined as a parameter that indicates the number of days payments can be submitted to CLM in advance.

-
- | Offsetting mechanisms are not available in CLM.
 - | For cash transfers related to CBOs, liquidity can be reserved in advance to separate it from the “non-reserved” part of the MCA.
 - | CBs can intervene on regular payment orders with status “warehoused” or “earmarked” by:
 - changing the set execution time;
 - revoking the payment orders.
 - | Regular payment orders that cannot settle immediately are queued. The payment orders within the queue are then processed following the FIFO-principle. CBs can intervene on queued payment orders by:
 - changing the set reject time;
 - re-ordering of queued payment orders;
 - revoking the queued payment orders.
 - | The FIFO-principle can be breached by a connected payment order decreasing the available liquidity, if the available liquidity is sufficient for the settlement of this order and no delta amount order to decrease the credit line is pending.
 - | CLM continuously attempts to settle the payment orders in the queue.

Unsuccessful entry disposition

If a submitted regular payment order cannot settle in the entry disposition, it is placed into the queue of payment orders according to the FIFO-principle.

Note: Contrary to regular payment orders, unsettled immediate liquidity transfers as well as unsettled connected payments are not placed into a queue and are rejected with appropriate error code in case of insufficient liquidity. Standing order liquidity transfer orders and rule-based liquidity transfer orders due to a floor configuration in RTGS or on another MCA within the same Liquidity Transfer Group or between two CLM accounts belonging to a CB are also not queued, but can settle partially.

Settlement of cash transfer orders in the entry disposition

In case there is already a payment order queued or an order to decrease the credit line pending, the submitted:

- | payment order (in case of a regular payment, i.e. not a connected payment) is queued;
- | immediate liquidity transfer order is rejected;
- | standing-order liquidity transfer order is partially settled with the amount of zero;
- | rule-based liquidity transfer order is rejected.

In case of a submitted connected payment order the system behaviour differs in the following way:

- I In case there is already a payment order queued, the submitted connected payment order is settled, if the available liquidity is sufficient (breach of FIFO-principle);
- I In case there is already a delta amount order to decrease the credit line pending, the submitted connected payment order
 - Decreasing the available liquidity is rejected;
 - Not decreasing the available liquidity is settled.
- I In case there is already a fixed amount order to decrease the credit line pending, the pending fixed amount credit line order is rejected, if the available liquidity is sufficient for the settlement of the submitted connected payment order.
 - If the liquidity needed for settling all queued/pending CBOs changes, CLM creates and sends a new automated liquidity transfer order to RTGS to pull liquidity from the linked RTGS DCA (linked through the Associated Liquidity Transfer Account attribute). The amount of this new automated liquidity transfer order is the sum of all queued/pending CBOs minus the available liquidity (that is still not sufficient to settle the first payment order queued or to decrease the credit line).
- I In case there are neither queued payment orders nor pending credit line decreases, the liquidity reserved on the MCA for CBOs is checked.
- I In case of sufficient liquidity on the reserved part, the CBO is settled.
- I In case of insufficient liquidity, the non-reserved part of the available liquidity on the MCA is checked.
 - If there is overall sufficient liquidity, the CBO is settled;
 - If there is not sufficient liquidity, a regular payment order is queued. Connected payments as well as liquidity transfer orders are rejected. In case of queued payment orders, CLM creates and sends an automated liquidity transfer to pull the missing liquidity from the linked RTGS DCA.

Note: As soon as a new automated liquidity transfer order arrives in RTGS, RTGS deletes the previously queued automated liquidity transfer order and considers only the current one with the sum of all queued/pending CBOs.

Further details on the processing are provided in chapter [Perform standard CLM settlement](#) [▶ 223] and chapter [Settle connected payments](#) [▶ 243].

Liquidity transfer orders in case of insufficient available liquidity

If there are no queued/pending CBOs and the available liquidity is sufficient, the liquidity transfer is immediately settled.

In case there are no queued/pending CBOs, but the available liquidity on the MCA or the CLM CB Account is not sufficient, the behaviour of CLM depends on the type of the liquidity transfer order.

- I **Immediate liquidity transfer order:** The immediate liquidity transfer order is rejected and a rejection notification ([Receipt \(camt.025\)](#) [▶ 479]) is sent to the CLM (CB) Account Holder who submitted the liquidity transfer order. Further details on the processing are provided in chapter [Perform standard CLM settlement](#) [▶ 223].

I Standing order liquidity transfer order: The standing order liquidity transfer is partially settled up to the amount that is available. In case that more than one standing order liquidity transfer order shall be settled at the same event, the available liquidity is used “pro rata” for all existing standing order liquidity transfer orders. For the remaining amount(s) that could not settle in the first settlement attempt no further attempt(s) take(s) place.

Note: In case there is no liquidity at all available to settle the standing order liquidity transfer order a partial settlement with the amount of zero takes place.

Further details on the processing are provided in chapter [Execute CLM standing order](#) [▶ 219].

I Rule-based liquidity transfer order: The rule-based liquidity transfer order

- from RTGS or
- from another MCA/CLM CB Account or
- between two CLM CB Accounts belonging to a CB

is partially settled up to the amount available. For the remaining amount that could not settle in the first settlement attempt, no further attempt takes place.

Note: In case there is no liquidity at all available in the non-reserved part of the MCA or CLM CB Account, the rule-based liquidity transfer order is rejected.³⁶ Further details on the processing are provided in chapter [Perform standard CLM settlement](#) [▶ 223].

Liquidity transfer type	Settlement
Immediate liquidity transfer	Only full settlement possible; otherwise immediate rejection.
Rule-based liquidity transfer	Partial settlement possible. In case of partial settlement, no further settlement attempt is performed.
Standing order liquidity transfer order	Partial settlement possible. In case of partial settlement, no further settlement attempt is performed. In case several standing order liquidity transfer orders are triggered with the same event, a pro rata execution applies.

Table 29 - Execution of liquidity transfers

The following table may serve as an example on how the entry disposition works in CLM:

³⁶ No rejection notification will be sent for these system generated liquidity transfers.

Action	Reserved part of the MCA for CBOs	Non-reserved part of the MCA	Queued/pending CBOs	Automated inter-service liquidity transfer queued in RTGS	Remarks
Start	100	50	0		
First CBO - amount: debiting 50	50 ↓	50	0		
Second CBO – amount: debiting 500	50	50	500 ↑	400 ↑	
Inter-service liquidity transfer from T2S – amount: crediting 10	50	60 ↑	500	390 ↓	
Third CBO – amount: debiting 150	50	60	650 ↑	540 ↑	
Intra-service liquidity transfer – amount: debiting 30	50	60	650	540	Rejected due to queued/pending CBOs
Automated liquidity transfer from RTGS – amount: crediting 300	50	360 ↑	650	240 ↓	
Automated liquidity transfer from RTGS – amount: crediting 240	0 ↓	0 ↓	0 ↓	0 ↓	Settlement of queued/pending CBOs as soon as additional liquidity from the automated liquidity transfer is available

Table 30 - Entry disposition - example

Rejection after the event “Cut-off for CLM RTS”

If a queued/pending payment order cannot be settled until the “Cut-off for CLM RTS”, this queued payment order is rejected.

Further details are provided in chapter [Process business day event “Cut-off for CLM RTS”](#) [▶ 270].

5.3.8.3 Comprehensive queue management

If a regular payment cannot be settled immediately, this payment order is placed in the queue.

Moreover, in case a credit line modification (i.e. decrease) cannot be executed immediately, this modification is placed on top of the queue.

As long as queued payment orders are not settled, the CB can intervene (i.e. modify a payment order or revoke a payment order).

Note: The [modification of payment orders](#) [▶ 105] can be done in U2A only. However, the revocation of a queued payment order can be done in A2A as well as in U2A. Further details on the interventions done in U2A can be found in the CLM UHB, chapter "*Modify cash transfer order*". Further details on the processing of a revocation in A2A are provided in chapters [Revocation of payment orders](#) [▶ 106] and [Perform CLM payment order revocation](#) [▶ 216].

Three different control options are offered:

- | changing the set execution time (if already defined in the payment order before sending it to CLM);
- | re-ordering the queued payment order;
- | revocation of a queued payment order.

These control options enable the CB to react on changed conditions during the business day.

It is possible to re-order one or several queued payment orders at the same time.

In case it is not possible to execute an intervention, the CB is informed accordingly via a [ResolutionOfInvestigation \(camt.029\)](#) [▶ 561] message (if the intervention was done in A2A) or via a GUI screen (if the intervention was done in U2A).

In case of successful interventions, the process to resolve the queue in CLM is started.

Note: Connected payments are either fully settled or rejected. Therefore connected payments are not queued.

Changing the set execution time

In principle, payment orders can be submitted with a defined execution time. It is possible to include an earliest debit time indicator and/or a latest debit time indicator (see chapter [Definition of execution time](#) [▶ 98]).

In case a payment order submitted includes an earliest debit time indicator and/or a latest debit time indicator, it is possible to change such an indicator via U2A as long as the time is not reached:

Action	Effect
Deleting the earliest debit time indicator of a payment order (FromTime)	This payment order is not in the queue yet, as the earliest debit time indicator is not reached so far. With the deletion, the entry disposition is done by CLM and a first settlement attempt takes place. As a result, the CBO is either settled or put at the end of the queue.
Changing the earliest debit time indicator of a payment order (FromTime)	The payment order is not in the queue yet, but it is included in the settlement process from the new indicated time on.

Table 31 - Effect of changing the execution time

Note: Since the deletion or modification of the latest debit time indicator has no direct effect on the queue management, it has not been considered in the table.

Re-ordering the queued payment orders

The CB can change the queue position for a single or several queued payment orders via U2A. The queued payment order selected can be placed on:

- | the top of the queue of payment orders;
- | the end of the queue of payment orders.

Action	Effect
Moving a payment order to the top of the queue	Immediate check whether the new payment order on top (and possibly any further in the queue) can be processed
Moving a payment order from the top to the end of the queue	
Moving a payment order that is not on top to the end of the queue	The action is taken into account during the next settlement process – no immediate attempt to settle.

Table 32 - Effect of changing the order of queued payment orders

In case of such a change, the payment order:

- | keeps its original submission time;
- | and is placed in the queue according to the change.

Note: A pending credit line modification always remains on top and cannot be re-ordered.

Revocation of a queued payment order

A CB can revoke queued payment orders. The revocation can be done via A2A and U2A. The queue of payment orders is reduced by the revoked payment order.

For further details, refer to chapter [Revocation of payment orders](#) [▶ 106].

5.3.8.4 Dissolution of the payment queue

The queue is resolved in an event-oriented way starting with the queued/pending CBO on top:

Events	By ...
Liquidity increase	<ul style="list-style-type: none"> incoming settled CBOs (i.e. credits on the MCA); incoming settled intra-service liquidity transfers; incoming inter-service liquidity transfers from other services/components.
Intervention on queue level	<ul style="list-style-type: none"> If there is a different payment order on top of the queue due to: <ul style="list-style-type: none"> – change of order; – revocation; – rejection of the payment order due to the fact that the latest debit time is reached.

Table 33 - Origin of possible events

As soon as one of the above-mentioned events occurs, further settlement attempts take place to settle the CBOs starting with the one on top of the queue.

The resolving queue process and the entry disposition are handled in the same way. If a single payment order cannot be settled, it remains in the queue (at maximum until the “Cut-off for CLM RTS”).

Note: Connected payments are either fully settled or rejected. Therefore, connected payments are not queued.

5.3.9 Cash transfer order processing times

An incoming A2A cash transfer order is processed depending on the type of the cash transfer order and the period of the business day. Detailed information on the business day can be found in chapter [Business day](#) [► 73] of the CLM UDFS.

In terms of processing time validation the following cash transfer order types are distinguished in CLM:

- | Regular or seizure of funds payment order with current business date;
- | Connected payment order with current business date;
- | Payment order with future business date (warehoused);
- | Liquidity transfer order (except standing facilities- and technical account-related orders);
- | Overnight deposit-related liquidity transfer order sent by CLM Account Holder;
- | Standing facilities- and technical account-related liquidity transfer order sent by CB.

After the successful technical validation, a processing time validation is conducted by checking the current system status and the cash transfer order type. The following figure depicts the possible results of the

processing time validation and assigns a colour which is used in figure [Processing of cash transfer orders during CLM business day](#) [▶ 117].

During maintenance window and currency specific closing, all incoming cash transfer orders are parked prior to the business validation. The following figure provides detailed information about the processing of the different cash transfer orders depending on the CLM business day phase.

	Regular or seizure of funds payment order with current business date	Connecte d payment order with current business date	Payment order with future business date (warehouse d)	Liquidity transfer order (except standing facilities- and technical account- related orders)	Overnight deposit- related liquidity transfer order sent by CLM Account Holder	Standing facilities- and technical account- related liquidity transfer order sent or by CB
<i>Change of business day</i> Planned time: 18:45 CET						
<i>Start of CLM RTS</i> Planned time: 19:00 CET						
19:30 <i>Execution of standing order liquidity transfers in CLM</i> Planned time: 19:30 CET						
<i>Cut-off for CLM RTS</i> Planned time: 18:00 CET						
<i>General cut-off for standing facilities</i> Planned time: 18:15 CET						
<i>CB cut-off for standing facilities</i> Planned time: 18:40 CET						
<i>Close of service</i>						

Results of processing time validation

- The incoming cash transfer order is accepted and processed after successful business validation.
- The incoming cash transfer order is rejected as the cut-off time for the cash transfer order type is reached.
- The incoming cash transfer order is parked before business validation. The business validation takes place in the next green phase.
Note: The cash transfer is not yet created in the system, i.e. the cash transfer order is neither visible on message nor on cash transfer level.
- The incoming cash transfer order is parked during EoD close of service and SoD, but will be rejected after the start of settlement window for CBOs in CLM.

Figure 23 - Processing of cash transfer orders during CLM business day

5.4 Liquidity management

5.4.1 Available liquidity

The MCA is used for the settlement of:

- | inter-service and intra-service liquidity transfer orders;
- | payment orders in the context of CBOs;
- | invoices for billable items.

The available liquidity on an MCA is defined as follows:

- | the balance on the MCA;
- | plus the credit line³⁷ linked to the MCA;
- | [minus seized amount](#) [▶ 189].

Note: In case a CLM Account Holder has more than one MCA, the credit line can be linked to one MCA only. Also MCAs without a credit line can be used to settle payment orders and/or liquidity transfer orders. Each MCA is identified by a BIC11 which is used to identify the account within a payment order.

It is up to the CLM Account Holder to decide whether the available liquidity should be divided into:

- | a reserved part for payment orders and liquidity transfer orders which are sent to settle CBOs as well as for the execution of orders to decrease the credit line;
- | a non-reserved part.

This can be achieved by setting up a reservation for CBOs. Further details on the reservation of liquidity are provided in chapters [Liquidity reservation](#) [▶ 130] and [Manage current reservation in CLM](#) [▶ 253].

³⁷ CLM does not check that an CLM Account Holder is flagged in CRDM as allowed to get intraday credit.

Liquidity on the MCA consists of:

Liquidity on the MCA could be divided into (via reservation):

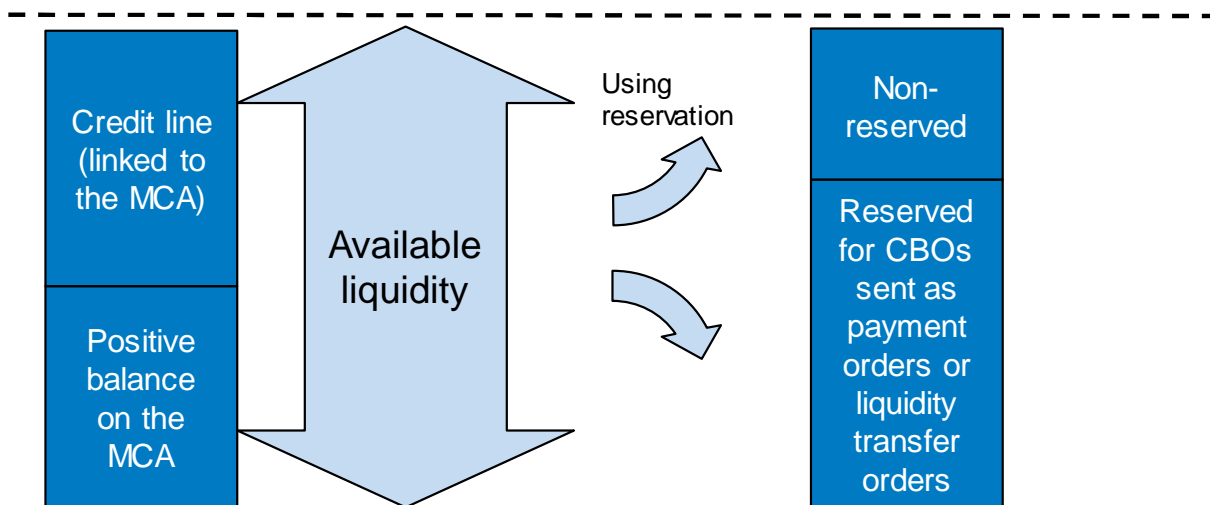

Figure 24 - Available liquidity – on MCAs without seized amount

By using the reservation function, the reserved part of the liquidity can neither be used for inter-service liquidity transfer orders nor for normal intra-service liquidity transfer orders (i.e. liquidity transfer orders not related to CBOs). The reserved liquidity is only available for the settlement of CBOs sent as payment orders or liquidity transfer orders.

5.4.2 Liquidity transfer

5.4.2.1 Overview

MCA is the central source of liquidity for the different settlement services. Therefore, CLM enables an efficient liquidity provision by offering liquidity transfer orders within CLM and to cash accounts held in other settlement services. These accounts are: RTGS DCAs, T2S DCAs, TIPS Accounts, CB Accounts in the relevant settlement services and RTGS sub-accounts.

Liquidity transfer orders can be initiated via A2A (except pulling liquidity from DCAs and TIPS Accounts) or U2A by:

- | a CLM Account Holder;
- | another actor on behalf of the CLM Account Holder;
- | a CB or
- | by CLM itself, based on the set-up in CRDM.

Liquidity transfer orders are used to:

		Debit Account									
		MCA	CLM CB Account	Overnight deposit account	Marginal lending account	RTGS DCA	RTGS sub-account	RTGS CB Account	TIPS Account	T2S DCA	T2S CB Account
Credit Account	MCA	X ^{1;3}	X ^{2;3}	X ⁵	X ⁶	X ^{3;4}	X	X ^{2;3}	X	X	X
	CLM CB Account	X ^{2;3}	X ³	-	-	X ^{2;3}	X	x	X	X	X
	Overnight deposit account	X ⁵	-	-	-	x	X	x	X	-	-
	Marginal lending account	X ⁶	-	-	-	-	-	-	-	-	-
	RTGS DCA	X ³	X ^{2;3}	-	-	N/A	N/A	N/A	N/A	N/A	N/A
	RTGS sub-account	X	X	-	-	N/A	N/A	N/A	N/A	N/A	N/A
	RTGS CB Account	X ^{2;3}	X ³	-	-	N/A	N/A	N/A	N/A	N/A	N/A
	TIPS Account	X	X	-	-	N/A	N/A	N/A	N/A	N/A	N/A
	T2S DCA	X	X	-	-	N/A	N/A	N/A	N/A	N/A	N/A
	T2S CB Account	X	X	-	-	N/A	N/A	N/A	N/A	N/A	N/A

intra-service liquidity transfers
inter-service liquidity transfers
N/A - not applicable in CLM
- option is not available

Figure 25 - Immediate liquidity transfer combinations from CLM service perspective

Please note the following details for the mentioned liquidity transfer combinations:

1. The combination is only possible within a defined Liquidity Transfer Group.
2. For rule-based liquidity transfers the combination refers to MCAs/RTGS DCAs belonging to a central bank modelled as party of party type “payment bank”.
3. Combinations referring to this number include rule-based liquidity transfers.
4. This number reflects the inclusion of automated liquidity transfers.
5. The respective liquidity transfers relate to overnight deposit, overnight deposit reverse and overnight deposit refund (further details on overnight deposit can be found in chapter [Overnight deposit](#) [▶ 145]).
6. Marginal lending on request (until the go-live of the ECMS); further details on marginal lending on request can be found in chapter [Marginal lending on request](#) [▶ 146]).

The settlement of inter-service liquidity transfers using CLM only as intermediary service does take place on the relevant transit accounts in CLM only. This part of the settlement is not represented in the table above.

The following types of liquidity transfers can be initiated in or by CLM:

Liquidity transfer type	Description
Immediate liquidity transfer order	Immediate transfer of liquidity initiated by the account holder or another authorised CLM Actor in A2A or U2A
Automated liquidity transfer order	Transfer of liquidity initiated by CLM sent to RTGS in order to transfer liquidity from the linked RTGS DCA (linked through the Associated Liquidity Transfer Account attribute) due a queued/pending CBO
Rule-based liquidity transfer order	Transfer of liquidity initiated by CLM towards an RTGS DCA or RTGS CB Account to be credited/debited or towards another MCA within the same Liquidity Transfer Group or a CLM CB Account due to a floor and/or ceiling rule (configuration done in CRDM)
Standing order liquidity transfer order	Recurring transfer of liquidity processed every business day at certain business day events (configuration done in CRDM)

Table 34 - Liquidity transfer order types

Depending on the type, a liquidity transfer order can either push liquidity to another cash account (e.g. debit the CLM Account Holder’s MCA and credit another cash account) or pull liquidity from another cash account (e.g. debit the linked RTGS DCA and credit the CLM Account Holder’s MCA).

With regard to the push or pull of liquidity, a liquidity transfer in CLM can be initiated towards the following settlement services:

Liquidity transfer type	Initiator	Use case	Push/Pull	Counterpart cash account in
Immediate liquidity transfer order	CLM Actor	Intra-service	Push	CLM ³⁸
		Inter-service	Push or pull ³⁹	RTGS, TIPS, T2S
Automated liquidity transfer order	System	Inter-service	Pull	RTGS
Rule-based liquidity		Intra-service	Push or pull	CLM ⁴⁰

38 In case of two MCAs involved, it is necessary to set up a Liquidity Transfer Group in advance.

39 A CLM Account Holder can “pull” liquidity from RTGS DCAs, T2S DCAs or TIPS Accounts by entering an immediate liquidity transfer order via U2A only. Further details are provided in the CLM UHB, chapter “Enter current liquidity transfer order”.

40 In case of two MCAs involved, it is necessary to set up a Liquidity Transfer Group in advance.

Liquidity transfer type	Initiator	Use case	Push/Pull	Counterpart cash account in
transfer order		Inter-service	Push or pull	RTGS
Standing order liquidity transfer order		Intra-service	Push	CLM ⁴¹
		Inter-service	Push	RTGS, TIPS, T2S

Table 35 - Liquidity transfer order directions

A liquidity transfer order (including rule-based liquidity transfer orders) can be executed **within** CLM (i.e. an intra-service liquidity transfer order) only if:

- | all involved MCAs belong to the same Liquidity Transfer Group;
- | or a CB Account (including overnight deposit accounts and marginal lending accounts) is involved.

Liquidity transfer orders are never queued in CLM, they are either:

- | earmarked (e.g. in case of blocking of a party);
- | settled immediately (fully or partially);
- | or rejected.

Note: The only type of liquidity transfer order that can be queued is an automated liquidity transfer order. However, an automated liquidity transfer order triggered in CLM can be queued in RTGS only.

5.4.2.2 Execution of liquidity transfers

As regards the execution of liquidity transfers in CLM the following principles apply:

41 In case of two MCAs involved, it is necessary to set up a Liquidity Transfer Group in advance.

Liquidity transfer type	Initiator	Frequency and trigger	Settlement
Immediate liquidity transfer	CLM (CB) Account Holder (or authorised CLM Actor)	Once immediately after the submission during the settlement window for liquidity transfer orders	Only settlement of the full amount is possible; otherwise it is immediately rejected.
Automated liquidity transfer	CLM	Automatically triggered whenever a CBO gets queued/pending in CLM	Partial settlement in RTGS is possible. In case of partial settlement, a new automated liquidity transfer order with the remaining amount is put on top of the queue in RTGS until the original amount of the automated liquidity transfer is completely settled.
Rule-based liquidity transfer	Pre-configured in CRDM	Automatically triggered by every breach of a configured floor/ceiling rule (only in case of a breach following the settlement of a payment)	Partial settlement is possible. In case of a partial settlement, no further settlement attempt is performed.
Standing order liquidity transfer order	Pre-configured in CRDM	Automatically triggered every business day at configured certain business day events	Partial settlement is possible. In case of a partial settlement, no further settlement attempt is performed. In case several standing order liquidity transfer orders are triggered at the same business day event, a pro rata execution applies.

Table 36 - Execution of liquidity transfers

For further details, refer to chapter [Processing of cash transfer orders](#) [▶ 107].

Note: Automated liquidity transfer orders with the remaining amount, which are created in case of partial settlement of automated liquidity transfers, are put on top of the queue in RTGS.

Note: Processing of liquidity transfer orders will not be possible from 19:00 – 19:30 but immediate liquidity transfers submitted during that time will be parked. Further details are provided in chapter "[Settlement window for liquidity transfer orders](#) [▶ 84]".

Detailed information regarding the initiation of liquidity transfer orders in U2A mode can be found in the CLM UHB, chapter "*Enter current liquidity transfer order*".

5.4.2.3 Liquidity transfer process

The processing of liquidity transfers is dependent on how and by whom the order is triggered. There is a need to distinguish between immediate liquidity transfers submitted by a CLM Actor (via [camt.050 LiquidityCreditTransfer](#) [▶ 505]) and system generated liquidity transfer orders (i.e. standing order liquidity transfer orders, rule-based and automated liquidity transfers).

In the following, some general process descriptions are provided. Further details on the processing of the different types of liquidity transfer orders are provided in chapters [Process CLM payment order and liquidity transfer order](#) [▶ 213], [Execute CLM standing order](#) [▶ 219], [Settle standing order in CLM](#) [▶ 220], [Perform standard CLM settlement](#) [▶ 223] and [Process automated liquidity transfer order with intermediate status](#) [▶ 235].

Information on the management of standing order liquidity transfer orders is provided in the CRDM UDFS.

5.4.2.3.1 Immediate inter-service liquidity transfer from a CLM (CB) Account to a dedicated account in a different settlement service

A CLM (CB) Account Holder can transfer liquidity from its MCA or CLM CB account to any RTGS DCA, T2S DCA, TIPS Account, CB account in another settlement service or an RTGS sub-account.

The following example shows the message flow from an MCA to an RTGS DCA; message flows for the other use cases will be similar:

Message flow

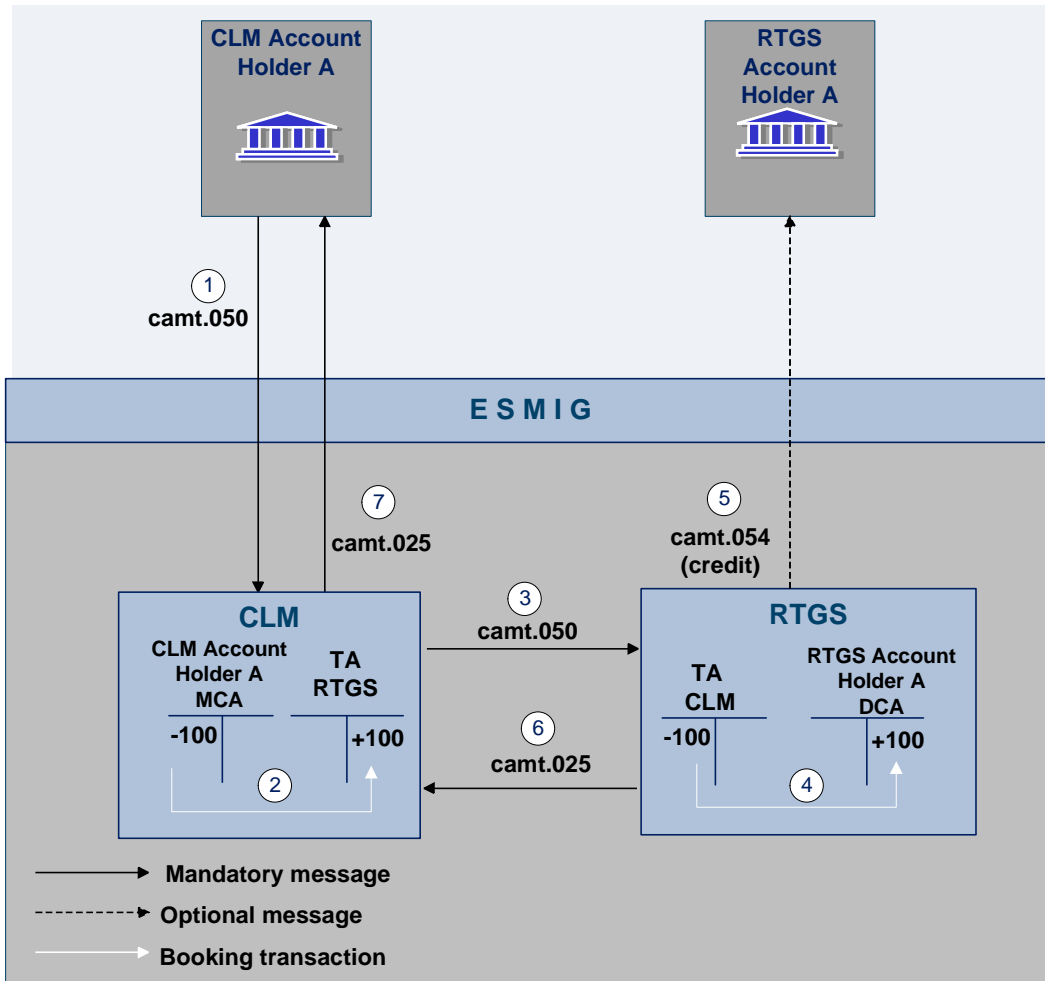

Figure 26 - Example camt.050 inter-service liquidity transfer from MCA to RTGS DCA

Process description

Step	Processing in/between	Description
1	CLM Account Holder via ESMIG to CLM	A LiquidityCreditTransfer (camt.050) [▶ 505] is sent from a CLM Account Holder via ESMIG to CLM.
2	CLM	Settlement on MCA and dedicated transit account for RTGS in CLM
3	CLM to RTGS	A LiquidityCreditTransfer (camt.050) is forwarded to RTGS.
4	RTGS	Settlement on dedicated transit account for CLM in RTGS and RTGS DCA

Step	Processing in/between	Description
5	RTGS via ESMIG to RTGS Account Holder	A BankToCustomerDebitCreditNotification (camt.054) (credit) [▶ 520] is sent by RTGS via ESMIG to the RTGS Account Holder (optional).
6	RTGS to CLM	A Receipt (camt.025) generated in RTGS is sent to CLM.
7	CLM via ESMIG to CLM Account Holder	A Receipt (camt.025) [▶ 479] is sent by CLM via ESMIG to the CLM Account Holder.

Table 37 - Inter-service liquidity transfer from MCA to RTGS DCA

Used messages

- I [LiquidityCreditTransfer \(camt.050\)](#) [▶ 505]
- I [BankToCustomerDebitCreditNotification \(camt.054\)](#) [▶ 520]
- I [Receipt \(camt.025\)](#) [▶ 479]

5.4.2.3.2 Immediate intra-service liquidity transfer between two CLM Accounts

A CLM Account Holder can transfer liquidity from one CLM Account to another CLM Account. In case of a liquidity transfer from one MCA to another MCA, both MCAs have to be in the same Liquidity Transfer Group in order to settle such intra-service liquidity transfer order.

Note: The set-up of a Liquidity Transfer Group is required for all intra-service liquidity transfers between two MCAs even if the MCA to be debited and the MCA to be credited belong to the same party.

It is also possible to transfer liquidity from a CLM CB Account or an overnight deposit account to an MCA and from an MCA to a CLM CB Account or an overnight deposit account⁴².

The following example shows a liquidity transfer between two MCAs; the message flow for the other use cases will be similar:

⁴² If the creditor account is an overnight deposit account, the debtor account must be an MCA owned by the party linked to the overnight deposit account to be credited. If the debtor account is an overnight deposit account, the creditor account must be an MCA owned by the party linked to the overnight deposit account to be debited.

Message flow

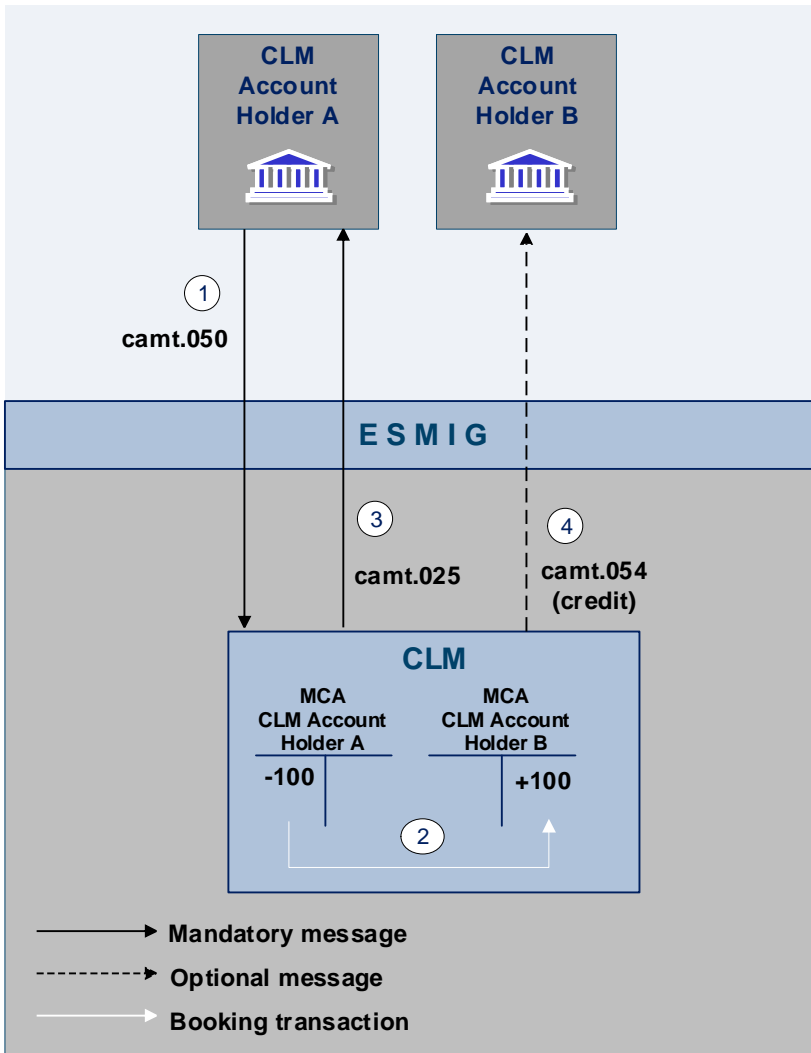

Figure 27 - Intra-service liquidity transfer order between two MCAs

Process description

Step	Processing in/between	Description
1	CLM Account Holder A via ESMIG to CLM	A LiquidityCreditTransfer (camt.050) [505] is sent from a CLM Account Holder A via ESMIG to CLM.
2	CLM	Settlement on MCAs.
3	CLM via ESMIG to CLM Account Holder A	A Receipt (camt.025) [479] is sent by CLM via ESMIG to a CLM Account Holder A.
4	CLM via ESMIG to CLM Account Holder B	A BankToCustomerDebitCreditNotification (camt.054) [520] is sent by CLM via ESMIG to a CLM Account Holder B (optional).

Table 38 - Intra-service liquidity transfer order between two MCAs

Used messages

- | [LiquidityCreditTransfer \(camt.050\)](#) [▶ 505]
- | [BankToCustomerDebitCreditNotification \(camt.054\)](#) [▶ 520]
- | [Receipt \(camt.025\)](#) [▶ 479]

5.4.2.3.3 Immediate inter-service liquidity transfer between two dedicated accounts in different settlement services

A settlement service/component account holder can transfer liquidity from a dedicated account in one settlement service to a dedicated account within another settlement service. These dedicated accounts are: RTGS DCAs, T2S DCAs, TIPS Accounts, CB accounts in the relevant service and RTGS sub-accounts.

In the example, an inter-service liquidity transfer between an RTGS DCA and a T2S DCA is shown; the message flows for other use cases are similar.

Message flow

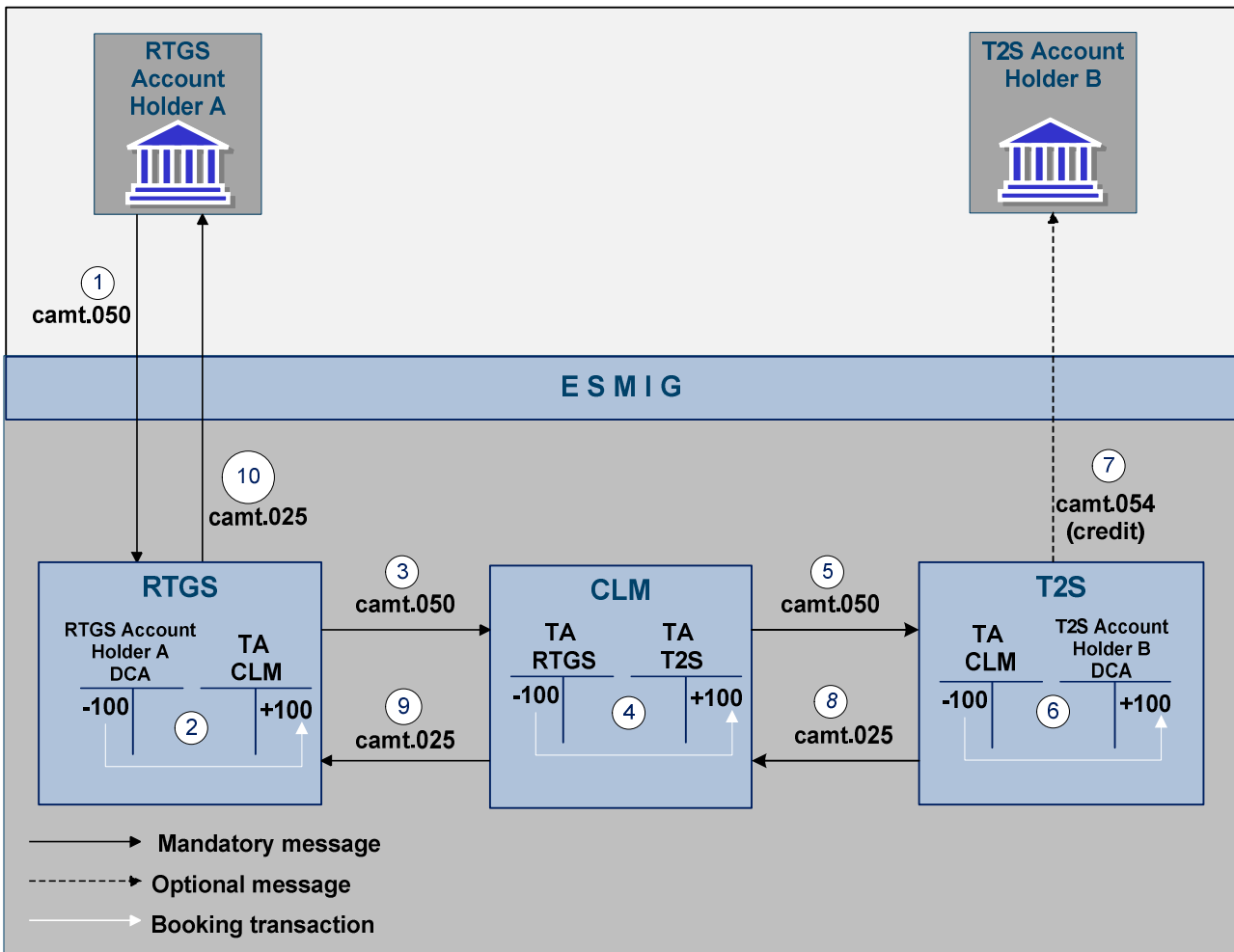

Figure 28 - Inter-service liquidity transfer between RTGS and T2S

Process description

Step	Processing in/between	Description
1	RTGS Account Holder via ESMIG to RTGS	A LiquidityCreditTransfer (camt.050) [▶ 505] is sent from an RTGS Account Holder via ESMIG to RTGS.
2	RTGS	Settlement on RTGS DCA and dedicated transit account for CLM in RTGS
3	RTGS to CLM	A LiquidityCreditTransfer (camt.050) is forwarded to CLM.
4	CLM	Settlement on the dedicated transit account for RTGS in CLM and the dedicated transit account for T2S in CLM
5	CLM to T2S	A LiquidityCreditTransfer (camt.050) is forwarded to T2S.
6	T2S	Settlement on the dedicated transit account for CLM in T2S and T2S DCA
7	T2S via ESMIG to T2S Account Holder	A BankToCustomerDebitCreditNotification (camt.054) [▶ 520] (credit) is sent by T2S via ESMIG to the T2S Account Holder (optional).
8	T2S to CLM	A Receipt (camt.025) generated in T2S is sent to CLM.
9	CLM to RTGS	CLM forwards the Receipt (camt.025) to RTGS.
10	RTGS via ESMIG to direct RTGS Account Holder	A Receipt (camt.025) [▶ 479] is sent by RTGS via ESMIG to the RTGS Account Holder.

Table 39 - Inter-service liquidity transfer between RTGS and T2S

Used messages

- | [LiquidityCreditTransfer \(camt.050\)](#) [▶ 505]
- | [BankToCustomerDebitCreditNotification \(camt.054\)](#) [▶ 520]
- | [Receipt \(camt.025\)](#) [▶ 479]

5.4.3 Liquidity management features

5.4.3.1 Automated liquidity transfer due to queued/pending CBO

always In case the available liquidity on the MCA is not sufficient to settle a CBO or to execute the seizure of funds or to reduce the credit line, CLM creates an automated liquidity transfer order in order to pull the missing liquidity from the RTGS DCA linked through the Associated Liquidity Transfer Account attribute in CRDM to the respective MCA.

In case of insufficient liquidity on the RTGS DCA, the automated liquidity transfer order is queued in RTGS.

In such a scenario any incoming liquidity (up to the required amount) on the RTGS DCA is transferred stepwise to the MCA in CLM until the original amount of the automated liquidity transfer order (i.e. the amount needed to settle the queued/pending CBO(s) or to execute the seizure of funds or to reduce the credit line in CLM) is completely settled. Further details on business day are provided in chapter [Business day](#) [▶ 73].

In RTGS, such an automated liquidity transfer is settled prior to any other debiting cash transfer order and as long as the complete amount of the automated liquidity transfer order is not settled, any liquidity decrease on the RTGS DCA is not possible.

If the needed liquidity for settling all queued/pending CBO changes or to execute the seizure of funds or to reduce the credit line (e.g. due to incoming liquidity) on the MCA is not available, CLM creates and sends a new automated liquidity transfer order to RTGS to pull liquidity from the linked RTGS DCA. The amount of this new automated liquidity transfer order is the sum of all queued/pending CBOs minus the available liquidity (that is still not sufficient to settle the first payment order queued or to decrease the credit line). As soon as a new automated liquidity transfer order arrives in RTGS, RTGS rejects the previously queued automated liquidity transfer order and considers only the current one with the sum of all queued/pending CBOs.

In case the incoming liquidity on the MCA is sufficient to settle all queued/pending CBOs, CLM always initiates the cancellation of the previously sent automated liquidity transfer order, regardless of whether it is still queued or has already been fully settled in RTGS. RTGS is notified that no liquidity is needed any more due to the fact that all queued/pending CBOs were settled on the MCA and RTGS cancels the automated liquidity transfer order if still queued in RTGS.

This notification is done via a new automated liquidity transfer order with an amount of zero generated by CLM towards RTGS, which then settles in RTGS and CLM.

Further details on the creation of automated liquidity transfer due to queued/pending CBOs are provided in chapter [Entry disposition](#) [▶ 107].

5.4.3.2 Liquidity reservation

5.4.3.2.1 Overview

CLM offers the possibility to a CLM Account Holder to reserve liquidity on the MCA for CBOs. The reserved liquidity is used for the settlement of CBOs including credit line decreases.⁴³

⁴³ The latter one uses the reserved part of the MCA only in case there is not enough liquidity on the non-reserved part of the MCA.

Reservations can be created, modified and deleted by the CLM Account Holder (or another actor acting on behalf) using A2A or U2A. Further details on the U2A functionality can be found in the CLM UHB.

The CLM Account Holder (or another actor acting on behalf) has the following possibilities:

- I create and/or modify reservations with immediate effect during the current business day as a current reservation in CLM, including:
 - establishing a specific amount during the current day with immediate effect as a current reservation (e.g. setting a new reservation of 300);
 - “resetting” to zero the liquidity reserved for the current business day only with immediate effect;
 - changing the amount on demand during the business day with immediate effect (e.g. from 300 to 200 or from 300 to 400).
- I create, modify or delete a standing order for reservation in CRDM valid as of the next business day in CLM until next change or the deletion of the standing order reservation amount.

In case the available liquidity on the MCA is lower than the amount to be reserved, the part which can be reserved will be reserved and the remaining part of the reservation will be queued (i.e. the pending value). CLM will process it in an event-oriented manner. Consequently, in case the available liquidity increases, CLM decreases the pending value and increases the respective reservation accordingly.

The liquidity reservation (with immediate effect as well as standing order reservation) is possible throughout the whole business day with certain exceptions (e.g. maintenance window). Further details on the business day are provided in chapter [Business day](#) [▶ 73].

Note: In case of need, a CB is allowed to seize a dedicated amount on the MCA by using a special reservation functionality which is available for CBs only. In case the liquidity on the MCA is not sufficient to (fully) execute a seizure of funds reservation and, at the same time, liquidity on the MCA is already reserved for CBOs, the seizure of funds reservation will respectively reduce the amount of the CBO reservation. Further details are provided in chapter [Seizure of funds](#) [▶ 189].

Standing order reservation

Standing order reservations are created and managed in CRDM. The amount defined in the standing order for reservation is valid at every SoD. Consequently, in case the reserved amount is changed directly in CLM, this changed amount is taken into account for the current business day only.

In case the amount of non-reserved available liquidity is not sufficient to fulfil the liquidity reservation set-up via standing order, the reservation is partially executed. CLM continues attempting to reserve the remaining amount until the reservation amount is reached whenever there is an increase of non-reserved liquidity on the MCA.

Current reservation with immediate effect

Current reservations are created and managed directly in CLM. As outlined above, it is possible to create a reservation for the current business day only. Moreover, it is possible to modify an existing reservation and to

“reset to zero” the amount of the reservation with immediate effect for the current business day only. Owing to the asynchronous processing in CLM, incoming liquidity might be blocked and used by a parallel settlement process before the attempt to increase the reservation is performed.

In case:

- | the event “Cut-off for CLM RTS” is reached;
- | a reservation revocation (status of original reservation order = to confirm) is received by CLM for processing;
- | a new reservation order (status of original reservation order = pending) is received by CLM for processing;

CLM stops processing the original reservation order. For the processing of the new reservation order, the new reservation replaces the pending one.

In case the amount of non-reserved available liquidity is not sufficient to fulfil the liquidity reservation order, the reservation is partially executed. CLM attempts to reserve the remaining amount until the reservation amount is reached whenever there is an increase of non-reserved liquidity on the MCA.

Further details on the management of a reservation are provided in chapters [Manage current reservation in CLM](#) [▶ 253], [Reject pending reservation modification in CLM](#) [▶ 257] and [Process business day event “Cut-off for CLM RTS”](#) [▶ 270].

5.4.3.2.2 Effect and tapping of liquidity reservation

Basic principles of liquidity tapping

CLM provides the opportunity to reserve a dedicated amount of liquidity for CBOs. The definition of a reservation determines the sequence of liquidity on how the liquidity on the account is used to settle CBOs. In case the liquidity on the MCA is not sufficient and CBOs are queued/pending, CLM pulls liquidity from the linked RTGS DCA (linked through the Associated Liquidity Transfer Account attribute) via an automated liquidity transfer order.

The generic sequence of liquidity tapping in CLM for debits on an MCA can be illustrated as follows:

Business case	Tapping of liquidity reservation				
	MCA		Linked RTGS DCA ⁴⁴		
	CBOs	Non-reserved	Urgent (U)	High (H)	Non-reserved

44 Related to automated liquidity transfer due to queued/pending CBO or seizure of funds or credit line decrease

Business case	Tapping of liquidity reservation				
	MCA		Linked RTGS DCA ⁴⁴		
	CBOs	Non-reserved	Urgent (U)	High (H)	Non-reserved
Credit line decrease	2	1	5	4	3
CBOs (including cash withdrawal; except credit line decrease)	1	2	5	4	3
Liquidity transfer – not related to CBOs		1			

Table 40 - Liquidity tapping in CLM

Numeric example of reservation usage

The following table explains the effect of the reservation functionality for the processing of cash transfers in CLM. It illustrates the changes of the different liquidity type sources and provides numeric examples:

Activity	Available liquidity on MCA of Bank A	Liquidity reserved for CBOs	Non-reserved liquidity
Start	1,000 (balance on the MCA: 800; credit line linked to MCA: 200)	300	700
Settlement liquidity transfer = 50 (debit)	950 ↓	300 ↔	650 ↓
Reimbursed marginal lending to CB = 200	750 ↓	100 ↓	650 ↔
Receiving liquidity transfer from Bank C = 20 (credit)	770 ↑	100 ↔	670 ↑
Set-up of overnight deposit = 100	670 ↓	0 ↓	670 ↔
Incoming liquidity from RTGS DCA = 80	750 ↑	0 ↔	750 ↑
Creation of current reservation = 200	750 ↔	200 ↑	550 ↓

Activity	Available liquidity on MCA of Bank A	Liquidity reserved for CBOs	Non-reserved liquidity
Credit line decrease = 150	600 (balance on the MCA: 550; credit line linked to MCA: 50)	200 ↔	400 ↓
Set-up of overnight deposit = 150	450 ↓	50 ↓	400 ↔
Submitting a "resetting to zero" reservation = 50	450 ↔	0 ↓	450 ↑

Table 41 - Usage of reserve for CBOs – numeric example

5.4.3.3 Floor/ceiling

5.4.3.3.1 Definition of floor/ceiling threshold

A floor is defined as a lower threshold which triggers – if breached - either the sending of a notification or the generation of a liquidity transfer order or both.

A ceiling is defined as an upper threshold which triggers – if breached - either the sending of a notification or the generation of a liquidity transfer order or both.

The target amount is the amount up to which the available liquidity (see chapter [Available liquidity](#) [▶ 118]) of an MCA or a CB Account:

- l is reduced in case it exceeds the ceiling threshold;
- l or increased in case it falls below the floor threshold.

Floor/ceiling target amounts may differ from the respective floor/ceiling amounts and are defined in CRDM by the account holder.

The floor/ceiling threshold is checked after the successful settlement of a payment order, the successful execution of a credit line modification, the successful execution of a seizure of funds reservation or the successful execution of a CBO reservation (ceiling only). This check verifies if the available liquidity on the MCA or CLM CB Account falls below the floor amount or exceeds the ceiling amount. Since this functionality is optional, it is up to the CLM Account Holder (or another actor acting on behalf of the MCA owner) or CLM CB Account Holder to define the floor/ceiling thresholds and target amounts in CRDM. Changes in CRDM are valid in CLM as of the next business day.

Two options are available which can be combined:

1. CLM generates a notification to be sent to the CLM Account Holder informing about the floor/ceiling breach (upon which the CLM Account Holder can take action, in case the automated generation of a rule-based liquidity transfer order has not been specified in CRDM too);
2. CLM automatically generates a rule-based liquidity transfer order:
 - for a floor:
 - either through a rule-based inter-service liquidity transfer order to pull an amount of liquidity from a predefined RTGS DCA or RTGS CB Account to be debited to reach a predefined amount (that can be different from the floor amount);
 - or through a rule-based intra-service liquidity transfer order to pull an amount of liquidity from another MCA within the same Liquidity Transfer Group of the MCA subject to the floor to reach a predefined target amount (that can be different from the floor amount).
 - for a ceiling:
 - either through a rule-based intra-service liquidity transfer order to push an amount of liquidity to another MCA within the same Liquidity Transfer Group of the MCA subject to the ceiling to reach a predefined target amount (that can be different from the ceiling amount);
 - or through a rule-based inter-service liquidity transfer order to push an amount of liquidity to a predefined RTGS DCA or RTGS CB Account to be credited to reach a predefined target amount (that can be different from the ceiling amount).
 - a rule-based intra-service liquidity transfer order between two CLM accounts belonging to a CB:
 - to pull an amount of liquidity to a CLM CB Account subject to the floor to reach a predefined target amount (that can be different from the floor amount) on that CLM CB Account from another CLM account belonging to that CB;
 - to push an amount of liquidity from a CLM CB Account subject to the ceiling to reach a predefined target amount (that can be different from the ceiling amount) on that CLM CB Account to another CLM account belonging to that CB;
 - to pull an amount of liquidity to an MCA belonging to a CB subject to the floor to reach a predefined target amount (that can be different from the floor amount) on that MCA from a CLM CB Account;
 - to push an amount of liquidity from an MCA belonging to a CB subject to the ceiling to reach a predefined target amount (that can be different from the ceiling amount) on that MCA to a CLM CB Account.

The predefined target amount is reached after the rule-based liquidity transfer to adjust the liquidity on the accounts involved has been settled and may differ from the respective floor/ceiling amount.

5.4.3.3.2 Breach of floor/ceiling threshold - notification

If the CLM Account Holder chooses the first option, CLM generates and sends out a notification with the information that the available liquidity on the MCA is below the floor or that the available liquidity is above the ceiling respectively:

- | in A2A mode (via [ReturnAccount \(camt.004\)](#) [▶ 380], [Process CLM floor and ceiling](#) [▶ 237]);
- | in U2A a broadcast will be displayed as an alert.

The notification is sent every time the threshold is breached. However, CLM does not send the notification if - after having passed the threshold - the available liquidity on the MCA or CB Account remains consistently below the floor or above the ceiling:

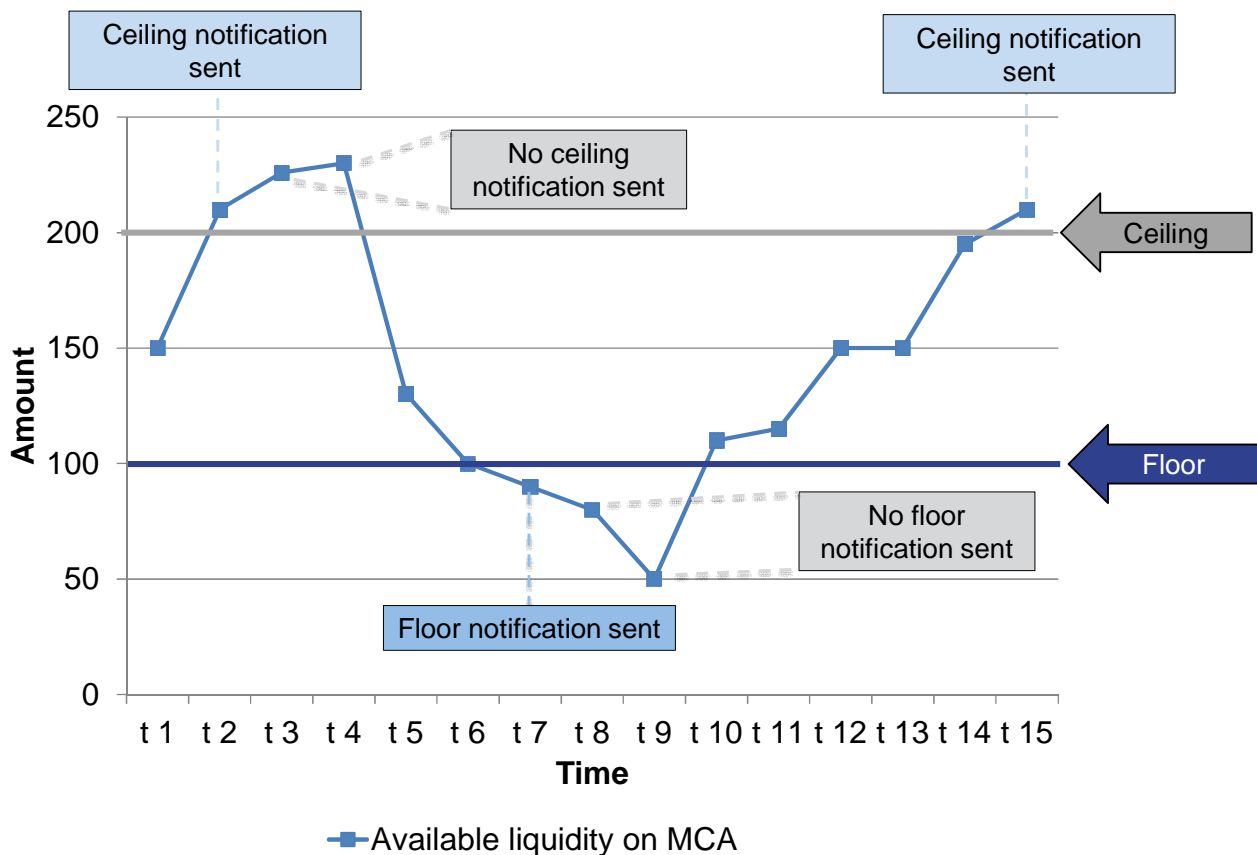

Figure 29 - Breach of floor/ceiling threshold – notification

5.4.3.3.3 Breach of floor/ceiling threshold – rule-based liquidity transfer

If the CLM Account Holder has chosen the second option, CLM creates and releases a rule-based inter-service liquidity transfer order. This can be either a

1. rule-based inter-service liquidity transfer with the following characteristics:

- I in case of a breach of the floor threshold, a certain amount is pulled from the RTGS DCA or RTGS CB Account and credited on the MCA or CB Account in CLM:
 - The used RTGS DCA or RTGS CB Account is predefined as the “Account to be debited for floor breach” in CRDM.
 - The amount to be transferred is the difference between the currently available liquidity on the MCA or CLM CB Account and the predefined target amount.
 - The target amount can be either equal or above the floor amount.
 - If the available liquidity on the RTGS DCA or RTGS CB Account is not sufficient, the liquidity transfer is partially settled in RTGS. No further settlement attempt takes place.
 - I in case of a breach of the ceiling threshold, a certain amount is pushed to the RTGS DCA or RTGS CB Account and debited on the MCA or CLM CB Account in CLM:
 - the used RTGS DCA or RTGS CB Account is predefined as the “Account to be credited for ceiling breach” in CRDM;
 - the amount to be transferred to the RTGS DCA or RTGS CB Account is the difference between the currently available liquidity on the MCA or CLM CB Account and the predefined target amount;
 - the target amount can be equal or below the ceiling amount;
 - the target amount for ceiling is independent from the target amount of the floor threshold and could be the same.
2. or a rule-based intra-service liquidity transfer with the following characteristics:
- I in case of a breach of the floor threshold, a certain amount is pulled from another MCA within the same Liquidity Transfer Group or a CLM CB Account and credited on the MCA or CLM CB Account subject to the floor configuration:
 - the MCA or CLM CB Account to be debited is predefined as the “Account to be debited for floor breach” as defined in CRDM;
 - the amount to be transferred is the difference between the currently available liquidity on the MCA or CLM CB Account subject to the floor and the predefined target amount;
 - the target amount can be either equal or above the floor amount;
 - if the available liquidity on the MCA or CLM CB Account to be debited is not sufficient, the liquidity transfer is partially settled in CLM. No further settlement attempt takes place.
 - I in case of a breach of the ceiling threshold, a certain amount is pushed to another MCA within the same Liquidity Transfer Group or CB Account and debited to the MCA or CLM CB Account subject to the ceiling configuration:
 - the MCA or CLM CB Account to be credited is predefined as the “Account to be credited for ceiling breach” in CRDM;
 - the amount to be transferred to the MCA or CLM CB Account to be credited is the difference between the currently available liquidity on the MCA or CLM CB Account subject to the ceiling and the predefined target amount;

- the target amount can be equal or below the ceiling amount;
- the target amount for ceiling is independent from the target amount of the floor threshold and could be the same.

Note: A ceiling breach does not trigger a liquidity transfer as long as a pending credit line modification, a pending seizure of funds reservation, a pending CBO reservation or a queued payment order exists for the MCA or CLM CB Account (see chapter [Effective settlement/execution order](#) [▶ 107]).

In case the amount reserved for CBOs is higher than the predefined target amount after a ceiling breach, the amount reserved for CBOs is used as target amount for the calculation of the transfer amount.

After the successful execution of either an inter-service or an intra-service liquidity transfer, the available liquidity on the MCA or CLM CB Account is within the boundaries of the floor or ceiling amount again.

Note: This may not be the case if the configuration of thresholds and target amounts in CRDM has not been properly configured.

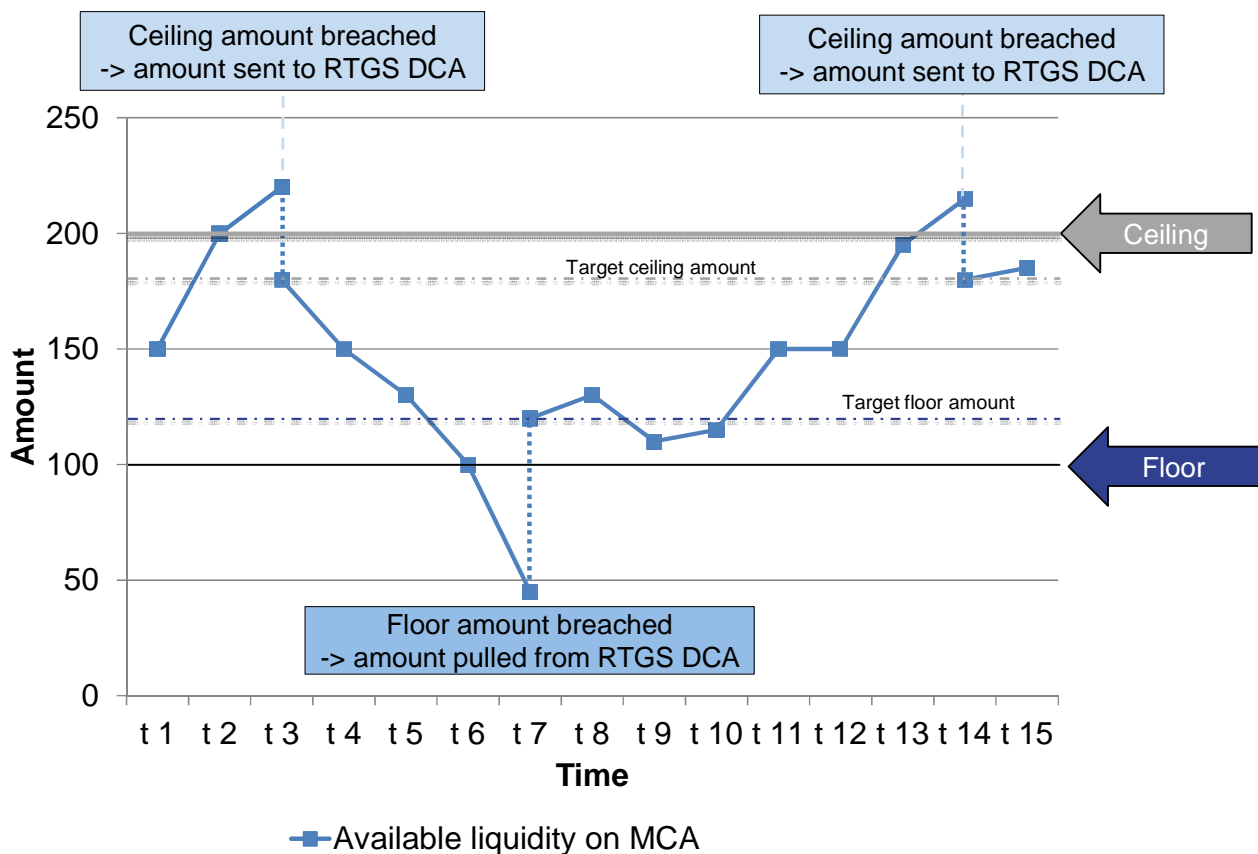

Figure 30 - Breach of floor/ceiling threshold – rule-based liquidity transfer

5.5 Minimum reserve management and interest calculation

5.5.1 Overview

Institutions may be required to hold a certain amount of funds as reserves in their current accounts at their CB. These are called minimum reserves. Institutions subject to minimum reserve requirements have to make sure that they meet the minimum reserve requirement on average over the maintenance period. They are not obliged to hold the total sum in their current accounts at the CB on a daily basis.

At the end of the maintenance period, the CB verifies the minimum reserve fulfilment and pays interest on their minimum reserve holdings – the interest rate is equivalent to the average of the marginal interest rate of the main refinancing operation (MRO) conducted during the reserve maintenance period (can also have zero value). CLM uses the rates defined in CRDM and propagated for the respective business day.

The following set-ups⁴⁵ are possible for holding minimum reserves (mutually exclusive for a party):

1. direct holding of minimum reserves;
2. indirect holding of minimum reserves through a leading CLM Account Holder;
3. holding of minimum reserves in a pool of reserve accounts;
4. not subject to minimum reserves.

The amount of minimum reserves to be held by each institution in respect of a particular maintenance period is calculated per institution by the responsible CB. The value for the upcoming minimum reserve maintenance period can be entered in A2A as well as in U2A mode. In case of need, it is also possible for the CB to update the reserve requirement of an institution during the current maintenance period. In such case, the new total amount needs to be defined by the responsible CB.

Details on the processing in A2A are provided in chapter [Maintain minimum reserve requirement order](#) [► 285]. Further details on the processing in U2A are provided in the UHB.

Institutions subject to minimum reserve requirements, which, on a daily average, hold higher amounts of funds than required (i.e. excess reserves) or hold accounts which are not used for the fulfilment of minimum reserve requirements, might be subject to (a different) interest calculation. Also account holders not subject to minimum reserve requirements might nevertheless be subject to interest calculation due to possible other purposes.

The remuneration of the excess of the minimum reserve requirements is split and remunerated with two different interest rates (“two-tier-system”).

- I The excess reserve interest rate “exempt tier”: it is applied to the excess reserve amount up to/equal to the value “Minimum reserve requirement * n” (the so called “excess reserve exemption amount”). “n” is the “Factor for the calculation of the excess reserve exemption amount” and limited as follows:

⁴⁵ The CBs are in charge of the set-up and maintenance.

99.99=>n>=0 (**Note:** the possibility to use the value '0' allows the "deactivation" of the feature, i.e. the exempt tier of excess liquidity holdings would be set to zero for all institutions).

- I The excess reserve interest rate "non-exempt tier": it is applied to the excess reserve amount beyond "Minimum reserve requirement * n" (the so called "excess reserve remuneration amount").

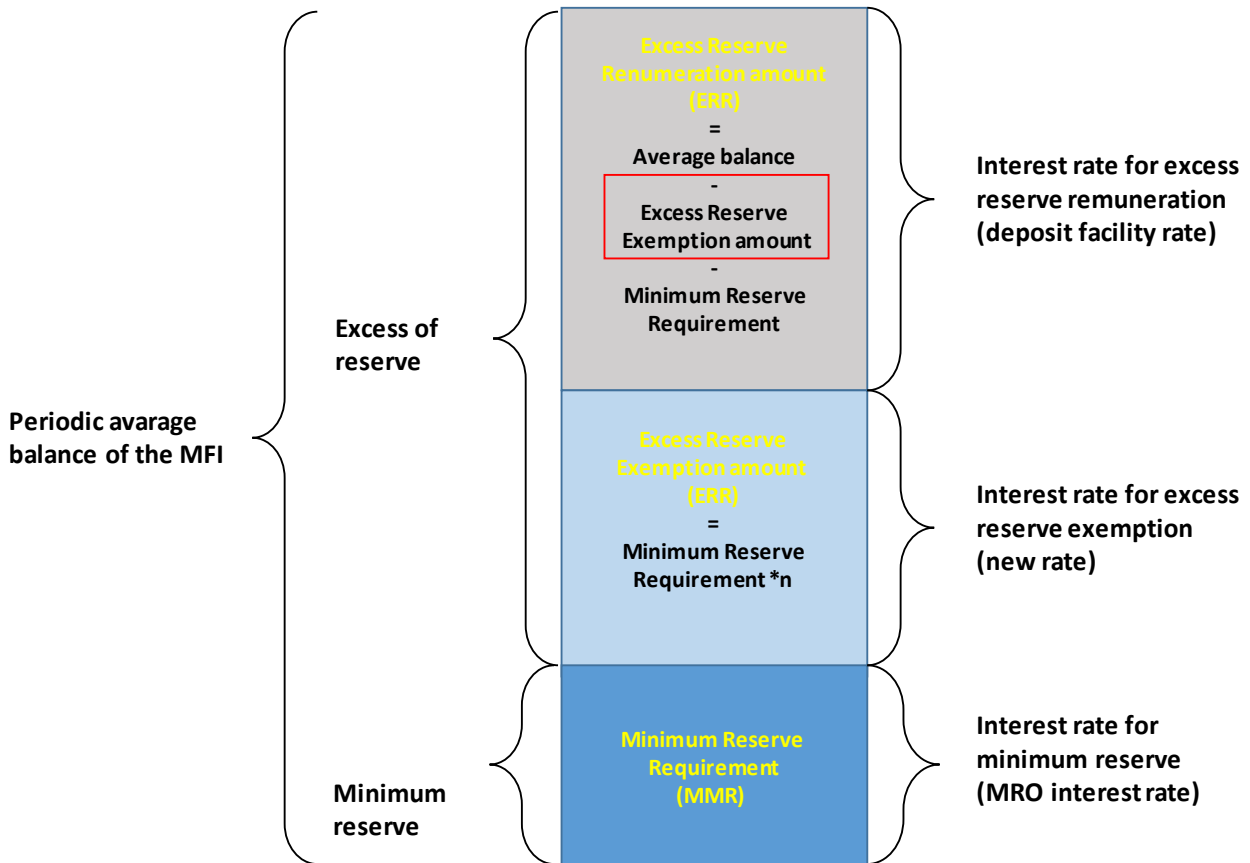

Figure 31 - Excess reserve remuneration

More information on the set-up for minimum reserve management and interest calculation can be found in chapter [Static data configuration for minimum reserve management and interest calculation](#) [▶ 61] and in the CRDM UDFS, chapter "Configuration parameters > Minimum Reserve Configuration".

Direct holding of minimum reserves

Institutions may be required to hold deposits on accounts with their CB. These deposits are called "minimum" or "required" reserves. A party shall hold its minimum reserves on one or more reserve accounts (MCA(s) and/or DCA(s) and/or TIPS Account(s)) with the respective CB.

Note: The institution needs to define a leading CLM Account Holder. Details are provided in CRDM UDFS, chapter "Description of the entities > Reserve Management Account Configuration".

Indirect holding of minimum reserves through a leading CLM Account Holder

An institution may hold all its minimum reserves indirectly through an intermediary (indicated through leading CLM Account Holder) belonging to the same CB. Such intermediary needs to be an institution subject to reserve requirements. In line with the legal regulations on the implementation of the Eurosystem monetary policy framework, CLM offers also the possibility of managing indirectly the reserve requirements and the excess reserves. Institutions using an intermediary to fulfil their minimum reserve requirements shall not be eligible for the two-tier system. Hence, all holdings of these institutions will continue to be defined as (non-exempt tier of) excess liquidity holdings.

On the basis of the list of institutions that decide to fulfil minimum reserves indirectly and of the intermediaries selected for its management, CLM is able to verify the fulfilment of minimum reserves and to calculate the excess reserves. Whether an institution is holding its minimum reserve directly or indirectly is defined by the responsible CB in CRDM.

In case of indirect reserve management, the total amount of the minimum reserves (i.e. the requirement for the intermediary plus the requirement for institutions managing their minimum reserves through this intermediary) is taken into account. However, only the balances on accounts held by the intermediary are considered for the fulfilment of the minimum reserve and for possible infringements of the minimum reserve requirements at the end of the maintenance period.

Cash accounts held by an institution which holds its minimum reserve indirectly may be considered in the context of minimum reserve-related interest calculations or may be subject to (possibly negative) interest due to other purposes depending on the configuration in CRDM.

Holding of minimum reserves in a pool of reserve accounts

Within CLM the pool functionality can be used, which enables the fulfilment of reserve requirements for a group of parties. This pool may comprise CLM accounts (i.e. MCAs) and also other cash accounts (in RTGS, T2S and TIPS).

The fulfilment of reserve requirements in a pool is evaluated on the basis of the sum of balances of all cash accounts (in CLM, RTGS, T2S and TIPS) belonging to the pool, even if, from a technical point of view, the minimum reserve of the institution is linked only to a single predefined MCA indicated through the leading CLM Account Holder.

No pooling is possible on a cross-border basis. At the end of the maintenance period the accrued interest is credited on the predefined MCA indicated through the leading CLM Account Holder.

The balances of all cash accounts belonging to a pool are considered for the calculation of the excess reserves as well as in case of an infringement penalty. The latter takes place only once it has been validated by the relevant CB.

It is not possible for a single CLM Account Holder to have access to both functions "pool of reserve accounts of different parties" and "Indirect holding of minimum reserves through a leading CLM Account Holder" at the

same time (which does not exclude that they act as intermediary for other MFIs holding their minimum reserves indirectly).

Besides the calculation on minimum reserve fulfilment, CLM also calculates the interest to be paid on accounts which are not considered for minimum reserve calculation and creates – if requested – the respective interest payments.

Further details on the processing of minimum reserve and interest are provided in chapter [Processing of minimum reserve and interest](#) [▶ 285].

Note: Institutions may be exempt from the fulfilment of their minimum reserve requirements upon request or in the reserve maintenance period in which an institution will cease to exist.

5.5.2 Collection of EoD balances

In order to calculate the fulfilment of the minimum reserve requirements, CLM needs the EoD balances of all relevant cash accounts held in all TARGET Services, i.e. DCAs of RTGS, T2S and TIPS Accounts as well as the balances on MCAs in CLM. During EoD, CLM collects the general ledgers from all other settlement services, which contain the cash account balance information to be taken into account for the minimum reserve calculation.

Only balances on cash accounts which are flagged in CRDM (see chapter [Reference data for parties used by CLM](#) [▶ 47]) as being relevant for minimum reserve are considered.

In addition to the EoD balances provided by CLM and other settlement services, CLM has to consider the adjustments sent by a CB via a separate process in A2A or U2A mode. Further details on the processing in A2A are provided in chapter [Insert or adjust balance for minimum reserve fulfilment](#) [▶ 287].

5.5.3 Daily calculations

Having received all EoD balances to be considered, CLM executes the following calculations for the current maintenance period on a daily basis.⁴⁶

- 1 **Accumulation of balances:** Building the sum of all relevant EoD balances of the cash accounts to be included in the minimum reserve requirement.
- 1 **Running average:** Calculated as the arithmetic mean of the accumulated balances from the first business day of the current maintenance period until the day before the next business day (i.e. on Friday the running average is calculated including Saturday and Sunday with Friday's balance).
- 1 **Adjustment balance:** In order to support institutions in managing the fulfilment of their minimum reserve requirements, CLM compares the running average with the minimum reserve requirement. The

⁴⁶ In case a balance or balances are missing, the "crisis management" decides about the way forward.

adjustment balance is the amount that is needed at the end of each business day in order to fulfil the minimum reserve requirement on a daily basis until the end of the maintenance period.

The calculations are done separately for each institution or each pool, if applicable, at the level of the leading CLM Account Holder.

The daily calculation may include also balances on accounts held outside the TARGET Services and is started after the settlement of standing facilities and before the start of the new business day. Further details on the business day are provided in chapter [Business day](#) [▶ 73]. Further details on adjustments sent by a CB are provided in chapter [Insert or adjust balance for minimum reserve fulfilment](#) [▶ 202].

5.5.4 Periodic calculations

At the end of the maintenance period, CLM calculates:

- l the interest to be paid to each institution or pool of reserve accounts for the amount up to the minimum reserve requirement according to the relevant interest rate;
- l the penalties related to the infringement of the minimum reserve requirements in case the running average during the maintenance period is lower than the minimum reserve requirement for the relevant institution or pool of reserve accounts;
- l the excess reserves and the interest on excess reserve⁴⁷ according to the relevant interest rates;
- l the interest for possible other purposes.

For institutions subject to minimum reserve requirements, the excess reserve is the difference between the aggregated EoD balance running average and the minimum reserve requirements. If an institution is eligible for the two-tier-system interests on excess reserve exemption amount and excess reserve remuneration amount are calculated.

In case of institutions subject to minimum reserve requirements, which hold their minimum reserve requirements indirectly through an intermediary, but hold an account in CLM for other purposes, the excess reserve is the aggregated EoD balance running average on the respective cash account.

Further details on the processing are provided in chapter [Process minimum reserve](#) [▶ 290].

Note: Balances on cash accounts of parties not subject to minimum reserve requirements (with the exception of CBs) may also be subject to [interest payments](#) [▶ 260]. The respective calculation is based on interest rates as set up in CRDM.

After the calculations at the end of the maintenance period took place, CLM sends a notification ([ReturnPeriodicInformationMinimumReserve \(camt.998\) - specific for CBs](#) [▶ 608]) to each CB including information on the minimum reserve fulfilment, due interest and possible penalties for the related institutions. "Due interest" comprises interest on minimum reserves and, (possibly negative) interests on excess reserves

⁴⁷ Reserve holdings exceeding the required minimum reserves are called "excess reserve".

(exempt tier and non-exempt tier in case the two-tier-system is applicable), and (possibly negative) interest due to other purposes, if applicable. Further details are provided in chapter [Process minimum reserve fulfilment notification](#) [▶ 296].

5.5.5 Generate payment orders

At the end of the maintenance period, CLM creates the following payment orders.

- | Payment orders related to interest on minimum reserve: based on the interest calculation, CLM creates the related payment orders for interest payments minimum reserve fulfilment. In case of an interest rate of 0.00 % no payment order is created.
- | Payment orders related to penalties: before creating the payment orders, a CB has to authorise the penalty and has to take a decision which penalty rate shall be applied. In case the penalty is cancelled by the CB, no payment order is created. Further details are provided in chapters [Administrate minimum reserve penalty](#) [▶ 203] and [Administrate minimum reserve penalty order](#) [▶ 293].
- | Payment orders for excess reserves: based on the interest calculation, CLM creates the related payment orders for excess reserve (different payment orders for the interests on excess reserve exemption amount and excess reserve remuneration amount). In case of an interest rate of 0.00 % no payment order is created.

In case of interest to be paid to the CLM Account Holder, the (leading) CLM Account Holder's default MCA is credited and the CB Account is debited.

In case of interest to be paid by the CLM Account Holder, the (leading) CLM Account Holder's default MCA is debited and the CB Account is credited.

Note: Interest for minimum reserve and for excess of minimum reserve are credited/debited two business days after the closing of each maintenance period, taking as a reference the TARGET calendar. Penalties related to infringement of minimum reserve are sent for settlement immediately after the validation process.

Further details on the processing are provided in chapter [Process minimum reserve](#) [▶ 290].

5.6 Standing facilities management

Standing facilities provide or absorb liquidity with an overnight maturity. Two standing facilities are available to eligible counterparties:

- | the deposit facility;
- | the marginal lending facility.

5.6.1 Overnight deposit

The deposit facility allows eligible counterparties to make overnight deposits with the CB. The overall processing of overnight deposit consists of three parts:

- | set-up of an overnight deposit;
- | overnight deposit reverse transaction;
- | overnight deposit reimbursement and processing of interest.

CLM Account Holders with access to monetary policy operations can use the deposit facility to make overnight deposits with their CBs.

In order to set up an overnight deposit, within CLM a CLM Account Holder can transfer liquidity from its MCA to the overnight deposit account dedicated to it.

Moreover Account Holders in other settlement services can transfer liquidity

- | as immediate liquidity transfer from an RTGS DCA, RTGS sub-account, RTGS CB Account or TIPS Account to an overnight deposit account or
- | as standing order liquidity transfer from an RTGS DCA, RTGS CB Account to an overnight deposit account.

It is possible to send several liquidity transfer orders to set up overnight deposits and the overall amount on the deposit account is increased accordingly.

Note: The owner of overnight deposit accounts to be set up is the CB. A CB has to open a separate overnight deposit account per monetary policy counterparty using the overnight deposit functionality.

It is also possible for the CLM Account Holder with access to the overnight deposit facility to instruct reverse transactions from the MCA in order to reduce the amount deposited on the overnight deposit accounts. This has to be initiated before the deadline for the usage of standing facilities. A CLM Account Holder can send several liquidity transfer orders as reverse transactions in order to decrease the overall amount on the deposit account accordingly. Reverse transactions can be of different amounts than liquidity transfers to overnight deposit accounts; i.e. there is no one-to-one relation.

The set-up and reversal of an overnight deposit can be initiated by:

- | an overnight deposit or reverse transaction request sent by the CB, the party owning the linked MCA or the co-manager of the account linked to the party in A2A using a liquidity transfer order;
- | manual input via U2A screen by the CB, the party owning the linked MCA or the co-manager of the account linked to the party.

The following principles apply to the processing of liquidity transfer orders linked to overnight deposits:

- | attempt to settle the liquidity transfer order immediately after its submission;
- | liquidity transfer orders are either settled completely or rejected (no partial settlement);
- | liquidity transfer orders are not queued.

The reimbursement of deposited capital and the processing of interest are performed by CLM at the beginning of the settlement window for CBOs. Further details on the business day are provided in chapter [Business day](#) [▶ 73].

CLM triggers automatically the following cash transfer orders:

- | Liquidity transfer order for the transfer of the capital amounts to the CLM Account Holder's default MCA;
- | in case of a positive interest rate, a payment order for interest payments to be paid to the CLM Account Holder's default MCA;
- | in case of a negative interest rate, a payment order for interest payments to be paid by the CLM Account Holders, i.e. to be debited on the CLM Account Holder's default MCA;
- | in case the calculation of the interests related to overnight deposit result in an amount which is lower than 0,005 EUR (e.g. 0,0002 EUR) no payment order for interest payments is created. CLM only credits/debits an interest amount of 0,01 EUR, if the amount of the interest calculated is equal or higher than 0,005 EUR and lower than 0,015 EUR.
- | In case of an interest rate of 0.00 % no payment order is created.

Details on the business day are provided in chapter [Business day](#) [▶ 73].

Further details on the processing via A2A are provided in chapters [Process overnight deposit - setting up order](#) [▶ 275], [Process overnight deposit - reverse order](#) [▶ 275] and [Process overnight deposit - refund and interest](#) [▶ 276].

Details on the handling via U2A are provided in the CLM UHB, chapter "*Enter overnight deposit*".

Note: For CBs outside the Eurosystem (see chapter [Specific requirements for out-CBs](#) [▶ 204]) interest are always accumulated on a monthly basis. In such scenario, CLM calculates the accumulated interest at the end of a calendar month and posts it five business days after the first business day of the following month (using warehoused payments). The respective CB has the possibility to check the calculated interest and to revoke the warehoused payment in case the calculation is not correct.

5.6.2 Marginal lending on request

5.6.2.1 Overview

The marginal lending facility allows eligible counterparties against eligible assets to obtain overnight liquidity from the CB.

The overall processing of marginal lending on request consists of:

- | set-up of marginal lending on request;
- | marginal lending on request reimbursement and processing of interest.

The marginal lending on request is requested by the CLM Account Holder at its CB. It is possible for the CLM Account Holder to request marginal lending at its CB until the general cut-off for the use of standing facilities. Further details on the business day are provided in chapter [Business day](#) [▶ 73].

5.6.2.2 Before launch of ECMS

Before the launch of the ECMS, the set-up of marginal lending on request is initiated in the CB's collateral management systems (CMS). The reimbursement and payment of interest are handled by CLM.

The marginal lending on request is initiated by the CLM Account Holder via its CB's CMS. Every CB is using its own CMS, which can be a system managed by the CB or a service provided by a collateral manager on behalf of the respective CB.

The responsible CB has to open dedicated marginal lending accounts in CLM – one for each CLM Account Holder eligible for marginal lending – for the settlement of marginal lending. For each CLM Account Holder marginal lending on request as well as automatic marginal lending settle on the same dedicated marginal lending account.

A marginal lending on request is set up in the CB's CMS. The CMS either sends a liquidity transfer order via an A2A message to CLM or the responsible CB creates marginal lending on request manually via U2A. The settlement of the marginal lending on request takes place on dedicated marginal lending accounts in CLM. The MCA of the CLM Account Holder requesting the marginal lending on request is credited and the dedicated marginal lending account in CLM is debited.

In general, the message flow is the same as for any other intra-service liquidity transfer with debit on the dedicated marginal lending account and credit on the linked default MCA, please see chapter [Immediate intra-service liquidity transfer between two CLM Accounts](#) [▶ 126].

A reverse of a settled marginal lending on request is only possible by the operator on behalf of the CB via U2A before the business day event "CB cut-off for standing facilities".

The reimbursement and the processing of interest are performed by CLM at the beginning of the settlement window for CBOs.

CLM triggers automatically the creation of the liquidity transfer order for the repayment of the capital amount and the payment order for the interest payment.

For the interest calculation CLM uses the relevant marginal lending interest rate. In case of multiple marginal lending operations, automatic and on request, for the same CLM Account Holder, the interest is calculated on the basis of the aggregated marginal lending amount and posted on the dedicated marginal lending account. The operator has the option to exclude for one currency as a whole marginal lending on request from the interest calculation. In this case, CLM does not calculate interest for marginal lending on request.

The liquidity transfer order for the reimbursement of a marginal lending on request leads to the debit on the CLM Account Holder's MCA and the credit on the respective marginal lending account. The interest payment order debits the CLM Account Holder's MCA and credits the CB Account.

Further details on the processing via A2A are provided in chapters [Standing facilities - specific functions for CBs](#) [▶ 203], [Process marginal lending on request - setting up order](#) [▶ 278], [Process marginal lending - reimbursement and interest](#) [▶ 282] and [Process marginal lending on request - reverse order](#) [▶ 279].

5.6.2.3 After launch of ECMS

As of its launch, ECMS replaces the CMSs of the national CBs. Consequently, a marginal lending on request submitted by a CLM Account Holder to its CB is handled by ECMS and ECMS interacts with CLM. Therefore, the setting up (disbursement) and reimbursement of a marginal lending on request as well as the calculation of interest are also handled by ECMS. For this purpose, payment orders to disburse and to reimburse the marginal lending amount and to post the interest are sent to CLM by ECMS.

Note: After the launch of ECMS marginal lending is settled on CB accounts in CLM without the use of dedicated marginal lending accounts. Instead, marginal lending is settled on an MCA defined by the CLM Account Holder.

A request for marginal lending is initiated by a CLM Account Holder (or an authorised sender or NCB user acting on behalf of the CLM Account Holder) in ECMS. ECMS validates the request, performs certain checks e.g. regarding collateral. If these checks are performed successfully, ECMS sends a payment order for the set-up (disbursement) of marginal lending on request. This payment order is settled on the default MCA defined by the CLM Account Holder (credit entry) and the NCB's CB Account (debit entry) in CLM and then confirmed to ECMS.

On the next business day upon successful completion of certain checks, ECMS sends a payment order for the reimbursement of the capital amount and interest of the accessed marginal lending on request to CLM. ECMS calculates the accrued interest based on the applicable marginal lending rate. Owing to netting of capital amounts and/or interest within ECMS,

- | the amount(s) of the payment order(s) may deviate from the capital amount and interest for that operation and
- | the (optional) [BankToCustomerDebitCreditNotification \(camt.054\)](#) [▶ 520] sent to the CLM (CB) Account Holder cannot provide detailed information on the business case(s) settled.

Hence, the (optional) debit notification sent to the CLM Account Holder cannot provide detailed information on the business case(s) settled.

Further details on the handling of marginal lending on request by ECMS can be found in the relevant ECMS documentation.

Further details on the processing of marginal lending on request after the launch of ECMS are provided in chapters [Process marginal lending on request - setting up order](#) [▶ 278], [Process marginal lending - reimbursement and interest](#) [▶ 282] and [Process marginal lending on request - reverse order](#) [▶ 279].

5.6.3 Automatic marginal lending

5.6.3.1 Overview

An overall negative balance on the MCA of a CLM Account Holder after the event Table 20 - [“CB cut-off for standing facilities”](#) [▶ 88] shall automatically be considered as a request by this CLM Account Holder for recourse to the marginal lending facility. The automatic marginal lending is used to transform an intraday credit into an overnight credit at the end of the business day in case the calculated overall aggregated balance of the institution on all of the cash accounts to be taken into account for the calculation is negative. The calculated overall aggregated balance is the sum of all balances of the institution’s DCAs (in RTGS and T2S), TIPS Accounts and MCAs. The process is initiated by CLM as part of the EoD process.

For the set-up of an automatic marginal lending, the respective CLM Account Holder needs to be allowed to use the marginal lending facility.

Before initiating the process, CLM makes sure that all EoD balances of the other settlement services (RTGS, TIPS and T2S) are available.

Further details on the business day are provided in chapter [Business day](#) [▶ 73].

In case an intraday credit cannot be transferred into an overnight credit due to the fact that a CLM Account Holder is not allowed to access the marginal lending facility, a spill-over notification is sent to the responsible CB.

5.6.3.2 Before launch of ECMS

Before the launch of ECMS the responsible CB has to open dedicated marginal lending accounts in CLM – one for each CLM Account Holder eligible for marginal lending – for the settlement of marginal lending. For each CLM Account Holder marginal lending on request as well as automatic marginal lending are settled on the same dedicated marginal lending account.

The payment orders for the settlement of automatic marginal lending are created and settled within CLM. The connected payment⁴⁸ linked to the settlement of an automatic marginal lending leads to a credit entry on the CLM Account Holder's MCA and a debit entry on the dedicated marginal lending account of the

⁴⁸ In case of connected payments created by CLM itself, the cut-off for the sending of payment orders from external actors and ECMS is of no relevance.

responsible CB in CLM. Simultaneously, this connected payment leads to a concurrent update (decrease) of the CLM Account Holder's credit line on the MCA.

The payment order for the reimbursement of the automatic marginal lending is created and settled automatically by CLM on the following business day at the beginning of the Table 16 - [Events and processes at the start of settlement window for CBOs](#) [▶ 84]. The payment linked to the reimbursement of an automatic marginal lending leads to a debit entry on the CLM Account Holder's MCA and a credit entry on the dedicated marginal lending account of the responsible CB in CLM. Simultaneously, this connected payment leads to a concurrent update (increase) of the CLM Account Holder's credit line on the MCA.

In addition to the reimbursement of the capital amount, CLM creates a payment order for the interest to be paid by the CLM Account Holder using the relevant marginal lending interest rate. For the reimbursement of the interest a regular payment is created by CLM. In case of multiple marginal lending operations, automatic and on request, for the same CLM Account Holder, the interest is calculated on the basis of the aggregated marginal lending amount by the CLM. The payment order is debited on the CLM Account Holder's MCA and credited on the CB Account of the responsible CB.

Note: The operator has the option to exclude for one currency as a whole marginal lending on request from the interest calculation. In this case, CLM does not calculate interest for marginal lending on request.

5.6.3.3 After launch of ECMS

After the launch of the ECMS marginal lending is settled on CB accounts in CLM without the use of dedicated marginal lending accounts. Instead, marginal lending is settled on an MCA defined by the CLM Account Holder.

The connected payments for the set-up and for the reimbursement of automatic marginal lending are created and settled within CLM.

All such payment orders as well as the open market operations within the responsibility of one NCB are settled on the counterparties' MCAs and an account of the responsible CB in CLM. The settlement of automatic marginal lending are communicated by CLM to ECMS and ECMS is responsible for generating the interest payments that will be processed by CLM. For the payment of interest ECMS creates a regular or connected payment using the relevant marginal lending interest rate. The interest amount can be subject to netting by ECMS.

Owing to netting within ECMS, the amount of the payment order for the interest payment for a marginal lending operation may deviate from the interest for that operation. Hence, the (optional) debit notification sent to the CLM Account Holder cannot provide detailed information on the business case settled.

Further details on the handling of marginal lending on request by ECMS can be found in the relevant ECMS documentation.

5.7 Information management for CLM

5.7.1 CLM status management

5.7.1.1 Concept

CLM informs its CLM Actors of the processing results for any kind of object. This information is provided to the CLM Actors via a status reporting which is managed by the status management. The communication of the status to CLM Actors is complemented by the communication of reason codes. In case of negative results of a CLM process, CLM provides the respective error code(s) accordingly.

5.7.1.2 Overview

The status management process manages the status updates of the different objects existing in CLM in order to communicate these status updates through status advice messages to the CLM Actors throughout the lifecycle of the object. Some status notifications are mandatory, others are provided on an optional basis. Status information on push basis is only available in A2A mode. Respective status advice messages are pushed via store-n-forward network service.

The status of an object is indicated through a value, which is subject to change through the lifecycle of the object. This value provides CLM Actors with information about the situation of this object with respect to a given CLM process at a certain point in time.

Since each object in CLM can be subject to several processes, each object in CLM may have several status. However, each of these status has one single value at a certain moment in time that indicates the object's situation at the considered moment. Depending on its object type, an object is submitted to different processes in CLM. Consequently, the status featuring each object depends on the considered object type.

The following chapters provide:

- | The generic principles for the communication of status and reason codes to CLM Actors.
- | The list of status featuring each object type as well as the possible values for each of these status.

Reason codes are provided within the respective message documentation in MyStandards and in chapter [Index of validation rules and error codes](#) [▶ 643].

5.7.1.3 Status management process

5.7.1.3.1 Status communication and types

Communication of status and reason codes to CLM Actors

CLM Actors can query the status values and reason codes of the objects linked to their instructions (e.g. cash transfers, tasks) during the day.

The status can be classified in the following two types, common to all types of objects.

- | “Intermediate status” - in general an object has more than one status in its lifetime. If the status of an object is not a final status type, then the object is still being processed in CLM. With each step in the process of the object the status changes until a final status is reached. Further status updates are communicated to the CLM Actors if reached.
- | “Final status” - this is the last status of an object (i.e. the status of an object when processing ends). At a point in time, any object in CLM reaches a final status and all respective processes are completed.

For some status updates mandatory information is provided. For other status updates, the status management process informs the CLM Actor of the status change by means of the sending status advice messages (according to their message subscription configuration – see chapter [Messaging](#) [▶ 59]).

Status and status values in CLM

As previously mentioned, the status of an instruction depend on the considered instruction type. The following paragraphs provide the list of status and status values. None of the status are stored for processing of queries.

Further details on the Unified Modelling Language (UML) conventions can be found in chapter [Processes with CLM](#) [▶ 207].

CLM status are:

- | CLM file status;
- | CLM message status;
- | cash transfer status;
- | task queue status.

5.7.1.3.2 CLM file status

CLM file status indicate the status of the file in CLM. There are the following status:

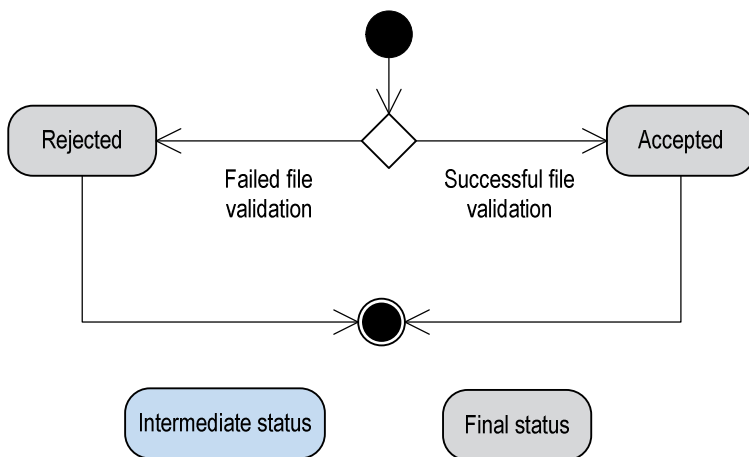

Figure 32 - CLM inbound file status diagram

Status value	Definition	Direction	Transition possible to status	Intermediate/final status	Reported via status notification to the sender
Accepted	File status if an incoming file is finally processed with positive validation result	Inbound	-	Final	-
Rejected	File status if an incoming file is finally processed with negative validation result	Inbound	-	Final	Mandatory

Table 42 - CLM inbound file status

5.7.1.3.3 CLM message status

CLM message status indicate the status of the message in CLM. They are the following status:

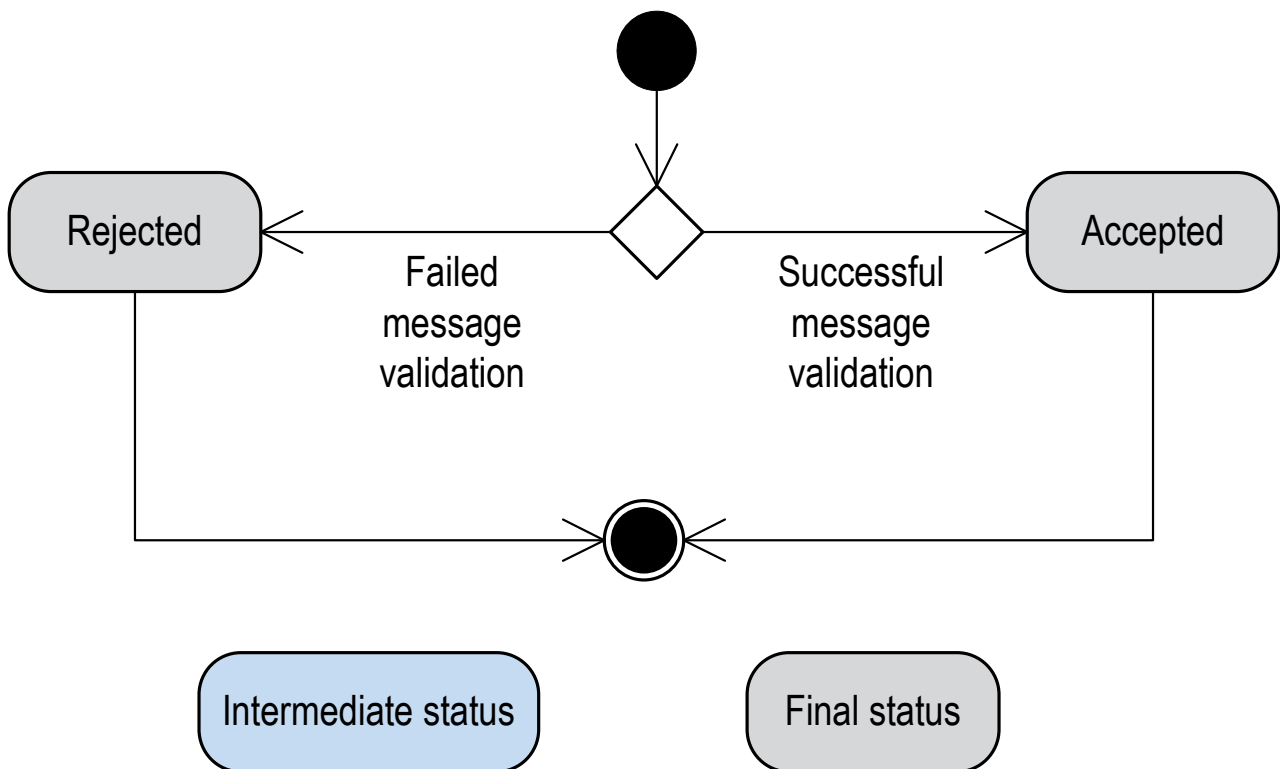

Figure 33 - CLM inbound message status diagram

Status value	Definition	Direction	Transition possible to status	Intermediate/final status	Reported via status notification to the sender
Accepted	Message status if an incoming message is finally processed with positive validation result	Inbound	-	Final	-
Rejected	Message status if an incoming message is finally processed with negative validation result	Inbound	-	Final	Mandatory
Provided	Status of an outgoing message sent to ESMIG	Outbound	-	Final	-

Table 43 - CLM message status

5.7.1.3.4 Cash transfer status

Indicates the status of the cash transfer in CLM and it can have the following status:

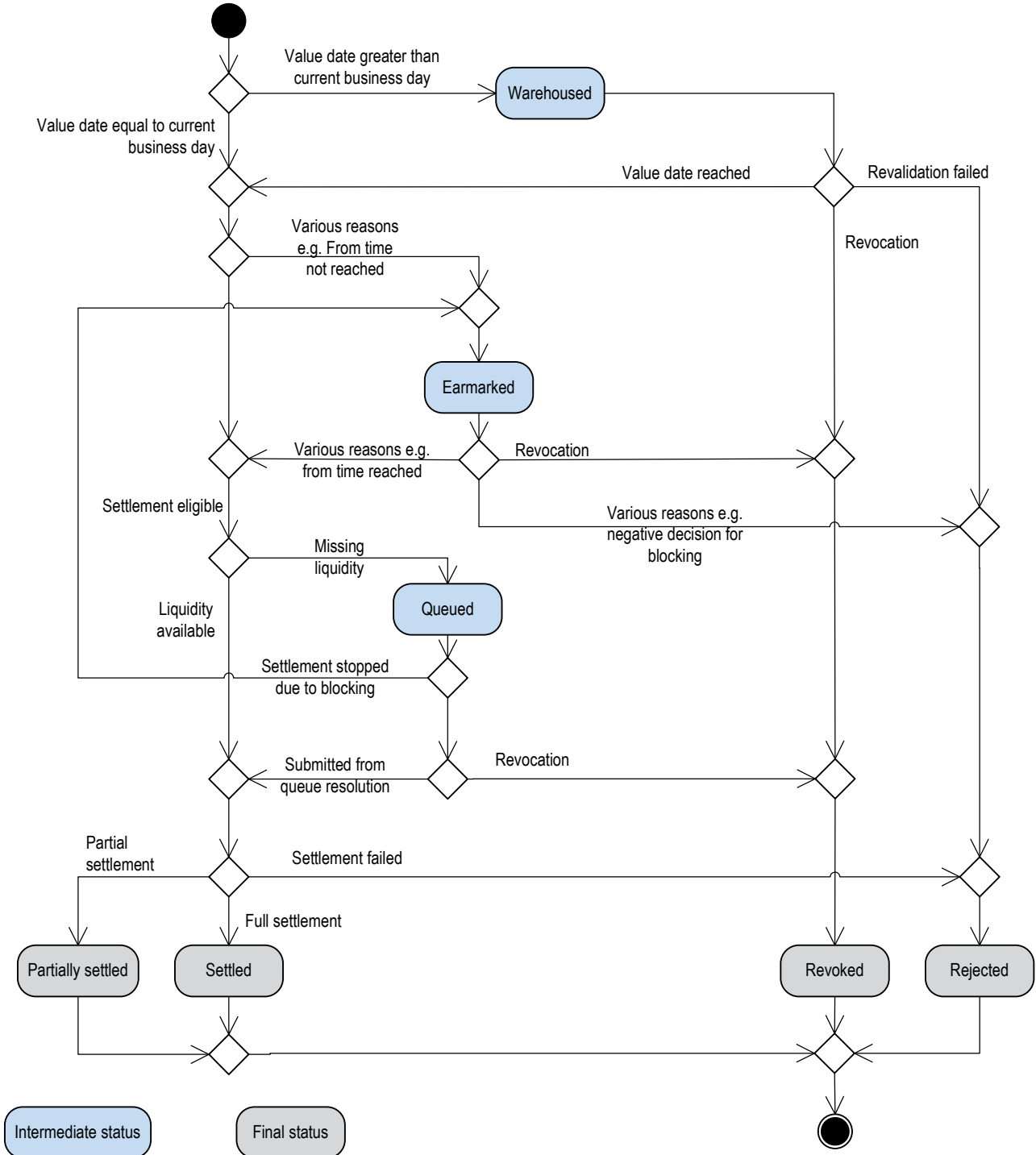

Figure 34 - Cash transfer status diagram

Status value	Definition	Transition possible to status	Intermediate/final status	Reported via status notification to the sender
Warehoused	Status of a cash transfer order with a value date of a future business day and status of a cash transfer order with the value date of the current business day until it is forwarded to the processing at the start of the business day - from then on they are processed normally. To this cash transfer status a time stamp is stored.	Earmarked, partially settled, queued, revoked, rejected, settled	Intermediate	-
Earmarked	Status of a cash transfer order which is ready for settlement but not taken into account for various reasons. The following scenarios are summarised in this status: <ul style="list-style-type: none"> pending start of settlement; accounting stopped due to earliest debit time indicator; due to parking on cash transfer level; accounting stopped due to blocking; pending decision on blocking. 	Queued, partially settled, revoked, rejected, settled	Intermediate	-
Queued	Status of a cash transfer order which is ready for settlement, but whose first settlement attempt was unsuccessful. Queued cash transfers are waiting for the next settlement attempt. To	Earmarked, partially settled, revoked, rejected, settled	Intermediate	-

Status value	Definition	Transition possible to status	Intermediate/final status	Reported via status notification to the sender
	this cash transfer status a time stamp is stored.			
Partially settled	Status of cash transfer after settlement with an amount lower than ordered. For business cases where the remaining (unsettled) amount should be settled the service creates a new cash transfer.	-	Final	Mandatory
Revoked	Status of a cash transfer which is revoked by a system user i.e. by an action to prevent the settlement of a cash transfer order.	-	Final	Mandatory
Rejected	Status of a cash transfer which is rejected by the system, i.e. by an action to refuse to continue processing (all cash transfers with error code, except error code for revoked).	-	Final	Mandatory
Settled	Status of a cash transfer after settlement. Final cash transfers cannot be revoked. To this cash transfer status a time stamp is added.	-	Final	Optional for payment orders, mandatory for liquidity transfers

Table 44 - Cash transfer status

5.7.1.3.5 Task queue order status

Indicates the status of the task queue in CLM and it can have the following status:

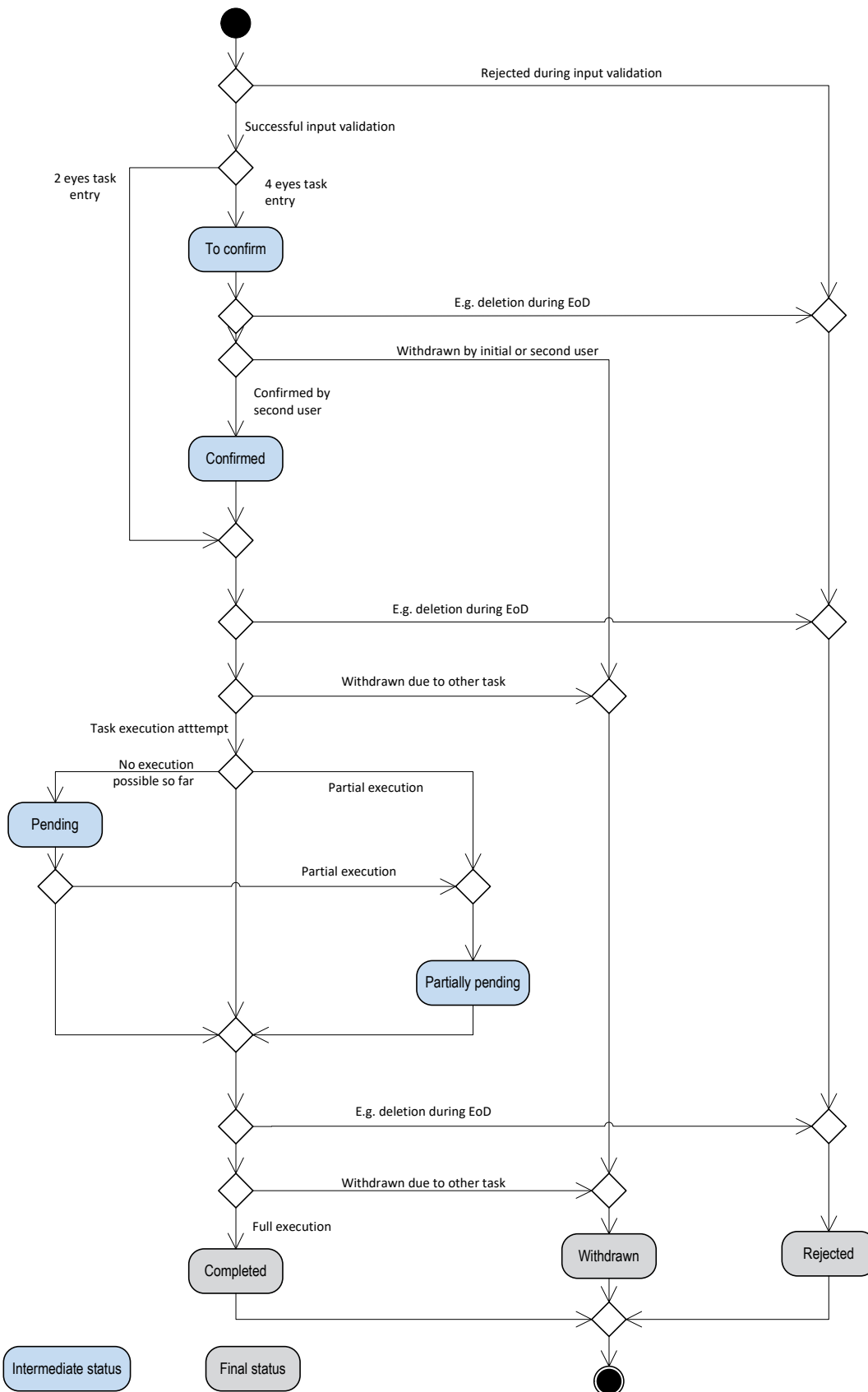

Figure 35 - Task queue order status diagram

Status value	Definition	Transition possible to status	Intermediate/final status	Reported via status notification to the sender
To confirm	The task must be confirmed by a second user and is not processed until another user action or a system-side rejection reactivates the processing. This status can only occur in U2A for four-eyes principle. It is the only status in which a task revocation (and confirmation) is possible directly via respective screens.	Confirmed, withdrawn, rejected	Intermediate	-
Confirmed	The task is confirmed by a second user and is ready for further processing. This status can only occur in U2A for four-eyes principle.	Pending, partially pending, completed, withdrawn, rejected	Intermediate	-
Pending	A task should be stored with status "pending", if the task was already tried to be processed at least one time but it could not be finalised. The processing was interrupted after the storage of entries initiated by the task and before the final processing of these entries. The task is updated and further processed, if the	Partially pending, completed, withdrawn, rejected	Intermediate	-

Status value	Definition	Transition possible to status	Intermediate/final status	Reported via status notification to the sender
	<p>preconditions for the pending status (e.g. liquidity increase) are changed.</p> <p>Note: Tasks with status “pending” can only be revoked via a new task. This processing rule applies for:</p> <ul style="list-style-type: none"> credit line changes (see Credit line management [190]); current reservations (see Liquidity reservation [130]). 			
Partially pending	<p>A task should be stored with status “partially pending” if the user's order cannot be processed completely (e.g. an increase of reservation cannot be executed completely because of lack of liquidity). The order is processed as far as possible. The task is updated and further processed, if the preconditions for the “partially pending” status (e.g. liquidity increase) are changed.</p>	Completed, withdrawn, rejected	Intermediate	-

Status value	Definition	Transition possible to status	Intermediate/final status	Reported via status notification to the sender
Withdrawn	Status based on an action by the user to prevent the processing during the four-eyes approval process.	-	Final	Mandatory
Rejected	Status based on an action by the system to refuse to continue processing.	-	Final	Mandatory
Completed	The task was processed successfully and the business case stemming from the task is final. The tasks changing an existing business case (like queue management) are completed, if the respective action is completely processed. The managed cash transfer does not have to be final. To this task queue status a time stamp is added.	-	Final	Mandatory

Table 45 - Task queue order status

5.7.2 CLM report generation

5.7.2.1 Concept

CLM provides the possibility to create the predefined report "statement of accounts" periodically. CLM triggers the generation of the "statement of accounts" report based on the reference data configuration. The "statement of accounts" is provided during the EoD processing. The report is not created intraday (i.e. it is not possible to define a scheduled time for receiving the report). For further details on the business day refer

to chapter [Business day](#) [▶ 73]. Depending on the CLM Actor's preferences the report is either sent out directly after creation or stored for later retrieval:

Report name	ISO message	ISO code
Statement of accounts	BankToCustomerStatement [▶ 511]	BankToCustomerStatement (camt.053) [▶ 511]

Table 46 - Statement of accounts - report

The respective business process is described in chapter [Receive CLM report](#) [▶ 302].

5.7.2.2 Overview

The report "statement of accounts" includes information on one single cash account of a CLM Actor. It is not possible to receive one combined "statement of accounts" for more than one cash account in CLM. Furthermore, it does not include information from other settlement services, i.e. there is no report including combined information of CLM and RTGS.

The report provides information about all items that are posted on a cash account and balance information of the current business day.

It is provided as a complete report, i.e. no delta version is offered.

Reports configuration and message subscription for notifications are different functionalities, i.e. no message subscription reference data is needed in case the report should be created and sent (latter in case of push mode).

5.7.2.3 Report generation process

Preconditions for report creation

In order to avoid unnecessary processing and storage CLM does not create reports automatically. To initiate the creation of a report, the report receiver has to configure the report in advance. The configuration is done via the CRDM GUI for the reference data, which is described in the CRDM UHB, chapter "*Create a New Report Configuration*".

This configuration is stored as reference data and is valid until the "valid to" date stored within the report configuration is reached. CLM uses the report configuration defined in CRDM and propagated for the respective business day.

Moment of data extraction

The creation of a "statement of accounts" report is always triggered during the EoD period of CLM after finalisation of settlement processes (CLM process "EoD reporting") – see [End-of-day period \(18:00 - 18:45](#)

[CET](#) [▶ 87]. A new report configuration can be set up for the next business day at the earliest. The respective component only creates those reports, whose report configuration is valid at the current business day.

Availability of the report in CLM

A generated report is available for query until it is replaced by a new version of it, i.e. a report that is created at the EoD of the current business day replaces the report that was created at the EoD of the previous business day. The replaced report is no longer available for query in CLM. In A2A mode CLM pushes the specific report, provided that the push preference for the report is stored for the respective recipient in reference data (i.e. report configuration). The message is sent out based on the routing information stored for the CLM Actor. Alternatively the report is just stored after generation and can be queried in pull mode.

Parameters for the set-up of a report

The following parameters are created and updated by the CRDM Actor (see CRDM UDFS, chapter "Report Configuration - New" and chapter "Report configuration") for the set-up of a report configuration:

Parameter	Mandatory/optional	Possible values	Further information
Report type	Mandatory	Statement of accounts	
Concerned account	Mandatory	Cash Account	
Possible recipient of a report	Mandatory	CLM Actor	
Communication channel	Mandatory	Push mode, pull mode	
Valid from	Optional	Date	If not stated, the next business date shall be used by default.
Valid to	Optional	Date	The field „Valid To“ is the only field that can be amended after the report configuration has been stored.

Table 47 - Parameters for the set-up of a report

Concerned account

Each report provides information on a certain scope of data. The data scope is indicated by the cash account for which it is configured. The feature is available for all cash account types in CLM.

The concerned account has to be specified, when the report is configured for the first time. It is necessary to store one configuration per cash account and recipient for which the report should be created.

Possible recipients of a report

All reports can be received by the technical address of:

- | concerned account owner;
- | another authorised party.

For each recipient (according to the report configuration for the cash account) an own report message is created. Each report configured in push mode is sent in store-and forward mode to the PTA that is defined in the routing configuration. As outlined in chapter [Communication between CLM and CLM Actors](#) [▶ 38], for reports each party can define through a conditional routing exactly one PTA deviating from the default routing the message shall be sent to. Each CLM Actor can decide if they wish to receive a report directly after its creation or rather query it on an ad hoc basis.

If a recipient wishes to receive a report directly after its creation, this has to be stored in the reference data configuration of the report in CRDM (communication channel = push mode). In this case reports can be received by the technical address defined for the cash account or by the technical address defined for the other authorised party (see chapter [Communication between CLM and CLM Actors](#) [▶ 38]).

If a recipient does not wish to receive a report directly after its creation but to be able to retrieve it afterwards, this has to be stored in the reference data configuration of the report as well (communication channel = pull mode).

Furthermore the recipient is stored as recipient of a report independent of the configuration with push or pull mode.

For information about the set-up of a report configuration for a specific concerned report recipient, see CRDM UHB, chapter "*Create a New Report Configuration*".

5.7.3 Query management for CLM

5.7.3.1 Concept for CLM

Queries are provided by CLM to the submitting actor as a means of satisfying the information needs on demand. The submitting actor can obtain information on different business items by submitting query requests to CLM. These are answered on the basis of the latest data available.

For requests on CLM queries using the specified (optional and mandatory) search and return criteria are available. Thus actors are not able to define these criteria by themselves.

The respective business process is described in chapter [Information services](#) [▶ 297].

5.7.3.2 Overview for CLM

CLM provides a range of predefined query types, which the submitting actor can use to request information on business items. The offered queries are available for all authorised submitting CLM Actors.

They can send query requests to CLM in A2A mode or in U2A mode. Generally, all these query requests are processed in real-time. Exceptions occur during the maintenance window. During the maintenance window query management does not service any requests. In case ESMIG is available and the network interface is not closed, an A2A query request during maintenance window is handled by using timeout management⁴⁹ or by CLM, providing a business message response containing the corresponding error. In case the network interface is closed the NSP informs the authorised submitting actor about the closure of the real-time channel.

5.7.3.3 Query management process for CLM

Initiating queries for CLM

In order to obtain the desired information the submitting actor needs to submit a query request to CLM. For the communication with CLM in A2A mode all query and response messages are set up as XML messages compliant with the ISO 20022 standard. For the communication with CLM in U2A mode a GUI based on a standard browser application is provided.

In general an authorised submitting actor can send each query request in A2A mode as well as in U2A mode. However, there are some queries which are only accessible via GUI in U2A mode. Query availability in the respective communication mode is shown in the table below. The respective messages are listed in Table 88 - [A2A messages for query processing](#) [▶ 300]. Query request and return criteria are described in detail in the CLM UHB for U2A mode, chapter "Screen User Guide - Description of Use Cases".

Query type	Initiation via GUI (U2A mode)	Initiation via XML message (A2A mode)
Account statement query	X	X
Audit trail for CLM query	X	-
Available liquidity CLM query	X	X
Available liquidity overall query	X	-
Broadcast query	X	-
Cash transfer query	X	X

⁴⁹ Timeout handling and the switch from store-n-forward message-based to store-n-forward file-based is handled in ESMIG. Respective details are provided in the ESMIG UDFS, chapter „Timeout and oversized management“.

Query type	Initiation via GUI (U2A mode)	Initiation via XML message (A2A mode)
Current reservations query	X	X
Event query	X	X
File query	X	-
Message query	X	-
Minimum reserve fulfilment query	X	X
System time query	-	X
Task queue query	X	-

Table 48 - Initiating queries for CLM

The different types of queries in CLM are static regarding the set of selection parameters, which can be mandatory, optional or conditional.

Note: Account Statements can be downloaded by U2A only CLM Account Holder (i.e. when the party is set up as U2A-only in CRDM). The download is possible for up to 10 business days.

Preconditions for successful processing of queries

CLM validates the plausibility of search criteria that were specified by the submitting actor. In addition, CLM ensures that the submitting actor of the query request is allowed to initiate the query and to retrieve the requested data by checking, whether the submitting actor possesses all necessary privileges granted in advance (taking into account the validity dates) and ensuring the data scope.

Providing data for queries

If all checks performed by CLM were successful, it extracts the requested business information from the production data. The submitting actor receives the latest available data. If any plausibility or authorisation checks performed by CLM fail, the submitting actor receives a response specifying the error(s) using the respective error code(s).

Retrieving the query response

In case the extraction of the query data is successful, CLM sends a query response containing the requested business information back to the requesting actor. In case the extraction of the query data returns a zero result, the submitting actor receives appropriate information. If the retrieval of the query result fails, then an error response is provided to the submitting actor.

In case the business data for the query response has to be included in more than one individual response message (e.g. pagination), CLM answers the query with an error response including a reference to the

necessary switch of the network channel via real-time network channel. Additionally, CLM provides the query response including the business data via store-n-forward network channel.

If the submitting actor sends the query via U2A mode, the response is given to the submitting actor in U2A mode.

Note: Comprehensive information on the U2A dialogue is provided in the CLM UHB.

If the submitting actor sends the query via A2A mode, the response is given to the same submitting actor in A2A mode. The CLM does not allow the routing of the query response to a dedicated technical address.

Parameter synthesis

No specific query configuration from the submitting actor is needed.

5.7.3.4 Specificities for delta set queries

The delta set query is a specific feature, which allows to query for a reduced set of cash transfer (orders) related to new items or already reported items with changed status according to the defined search and return criteria.

The following additional rules apply:

- | The feature is only available in A2A.
- | It is based on the cash transfer query messages, i.e. [GetTransaction \(camt.005\)](#) [▶ 411] and cash transfer query response message, i.e. [ReturnTransaction \(camt.006\)](#). [▶ 434]
- | Precondition for the usage is, that the delta set query is always sent by the same user (linked to the same party).
- | Delta set queries are possible for one or more accounts. In maximum, the user may query its full data scope within CLM.
- | For a delta set query a combination of search and return criteria is defined with the delta set initialisation query.
- | A delta set query is valid for one business day. Thus, one delta set initialisation query is necessary per business day and the query name returned by RTGS/CLM is valid throughout the whole business day.
- | A cash transfer (order) which newly fulfils the search criteria, is part of the delta set query response on the next delta set query. Additionally each cash transfer status update is part of the delta set query response. A cash transfer (order) which no longer fulfils the search criteria (e.g. due to modified cash transfer priority), is no longer part of the query response even if the status changes between two delta set queries.
- | In case a delta set query response is missing, a new delta set initialisation query is necessary to avoid gaps in the reported result sets.

5.7.4 Broadcasts

Broadcasts are information messages that CLM simultaneously provides to users in U2A and A2A – the latter, when the user has opted for A2A broadcasts. Broadcasts are either settlement-related or operations-related.

CLM automatically generates settlement-related broadcasts based on an explicitly defined business case.

A CB or the operator creates operations-related broadcasts through an U2A request. They can be sent as normal or alert broadcasts. CLM (CB) Account Holders are the recipients of broadcasts.

A2A broadcasts are system-generated messages which CLM sends independently from an account. CLM sends an A2A broadcast via [SystemEventNotification \(admi.004\)](#) [▶ 365] to the broadcast subscribing party based on the defined routing configuration for notifications being not a response to an instruction, but belonging to a business case triggered by an instruction (see chapter [Communication between CLM and CLM Actors](#) [▶ 38]).

5.7.4.1 Settlement-related broadcasts

CLM automatically generates settlement-related broadcasts on the basis of the following exhaustive list of specified business cases:

Business case	U2A availability	A2A availability	Linked business description	Linked process description
Latest debit time warning (RejectTime)	Yes	Yes	Definition of execution time [▶ 98]	Initiate CLM reject time broadcast [▶ 240] Process CLM reject time broadcast [▶ 241]
Floor notification	Yes	No ⁵⁰	Breach of floor/ceiling threshold - notification [▶ 136]	Process CLM floor and ceiling [▶ 237]
Ceiling notification	Yes	No ⁵¹	Breach of floor/ceiling threshold - notification [▶ 136]	Process CLM floor and ceiling [▶ 237]

Table 49 - Settlement-related broadcasts in CLM

50 Respective A2A notification is provided via [ReturnAccount \(camt.004\)](#) [▶ 378]. Thus no A2A broadcast is foreseen.

51 Respective A2A notification is provided via [ReturnAccount \(camt.004\)](#) [▶ 378]. Thus no A2A broadcast is foreseen.

5.7.4.2 Operations-related broadcasts

A CB or the operator creates operations-related broadcasts through an U2A request:

U2A availability	A2A availability	Linked process description
Yes	Yes	Initiate CLM operations-related broadcast [▶ 305] Process CLM operations-related broadcast [▶ 305]

Table 50 - Operations-related broadcasts in CLM

5.8 Provisioning of data for Billing

CLM provides the following transactional data for Billing:

- | submitting actor of the message;
- | cash transfer type;
- | number of transmissions;
- | business day.

5.9 The life cycle of a business case

5.9.1 Concept

A business case groups all messages, cash transfer (orders) and/or tasks linked to a party's order (initiated via U2A or A2A) or a system-generated activity based on party configuration. It is identified by a unique identifier dynamically assigned by CLM to the business case, adopts different processing states during its lifecycle and is related to one or more entities depending on the underlying business case (e.g. payment or change of credit line).

These possible entities are

- | inbound file (only for initiation with [BusinessFileHeader \(head.002\)](#) [▶ 555]),
- | inbound message (only for initiation via A2A),
- | cash transfer (order),
- | task (e.g. resulting from modifications of the cash transfer) and
- | outbound message.

All these entities share the same unique Business Case ID.

The current processing state of each linked entity is described by its own status. For further information on status values and possible status transitions please refer to chapter [Status management process](#) [▶ 152]. The status of a cash transfer in combination with the information on related entities provides the possibility to track the whole life cycle of a cash transfer.

5.9.2 Business Case ID specificities

An inbound file is completely processed after its successful splitting. Thus the business case for the inbound file is finalised after splitting. CLM handles each single message (extracted from the inbound file) separately.

When CLM receives an inbound message including a cash transfer order, it assigns a unique Business Case ID to this message. If an outbound message is created for these cash transfers then the same Business Case ID is assigned to the outbound message.

Any modification of a cash transfer order is represented by a task in CLM which inherits the Business Case ID from the cash transfer order to be modified. This Business Case ID is also allocated to the resulting [Receipt \(camt.025\)](#) [▶ 479] message. Thus all messages related to this business case can be searched for within CLM by using the Business Case ID.

If CLM receives a [FIToFIPaymentCancellationRequest \(camt.056\)](#) [▶ 573] message including a revocation, then this message is assigned the Business Case ID of the cash transfer order to be revoked. In case there is no match or it is in a final status or it is not successfully validated, then a new Business Case ID is assigned.

A [BankToCustomerStatement \(camt.053\)](#) [▶ 511] message includes the Business Case ID in the entry details for every cash transfer not containing an instruction Id or End-to-End ID. Details are provided in [BankToCustomerStatement \(camt.053\)](#) [▶ 511].

The Business Case ID is always unique within CLM. An inter-service liquidity transfer received by RTGS and subsequently processed in CLM gets two different Business Case IDs: one is created within RTGS and one is created within CLM. RTGS and CLM do not 'share' the same Business Case ID for the inter-service liquidity transfer.

5.9.3 Business case codes and their usage

A Business Case Code is a four-letter code indicating the business context of a business case related to a cash transfer or a credit line modification. A Business Case Code classifies a Business Case but does not clearly identify it (several Business Cases may share the same Business Case Code)

CLM uses codes for various cases:

- | For message subscription, CLM sends a [debit notification or credit notification \(camt.054\)](#) [▶ 520] to a business receiver if the account holder has subscribed for the message in CRDM. It is used to confirm the credit or debit of a certain entry on one of the account holder's CLM cash accounts.
- | For provision of entry details in [camt.053](#) [▶ 511] and [camt.054](#) [▶ 520]
- | For [cash transfer query](#) [▶ 411] and [query response](#) [▶ 434] ([camt.005](#) [▶ 411] and [camt.006](#) [▶ 434])

In the context of U2A and A2A cash transfer queries and query responses, the cash transfer category is a four-letter code indicating the business context of each cash transfer.

5.10 Impact of blocking on the processing of cash transfer orders

A CB can block a party as a whole or individual cash accounts. Details on the blocking of a party are provided in chapter [Blocking/unblocking party](#) [▶ 47] and details on the blocking of a cash account are provided in chapter [Blocking/unblocking account](#) [▶ 60].

Depending on the option chosen by the responsible CB, a cash account⁵² is blocked for:

1. debits and credits;
2. debits only;
3. credits only.

In case a cash account is blocked with immediate effect for debits and credits, the processing for the cash transfer order which are affected by the blocking is as follows.

- | In principle, no cash transfer orders (depending on the kind of blocking) can settle automatically on this cash account.
- | In principle, all queued cash transfer orders are set to "earmarked" after the blocking became effective and each cash transfer order requires the explicit confirmation by the CB before any further settlement attempt can take place.
- | New cash transfer orders received in CLM which shall settle on the blocked cash account are stored for confirmation by the CB.
 - If the CB gives its confirmation, the cash transfer orders run through the entry disposition. If they cannot be settled in the [Entry disposition](#) [▶ 107]:
 - regular payment orders are queued and are included in the process of [Dissolution of the payment queue](#) [▶ 116];
 - liquidity transfer orders are rejected after the unsuccessful settlement attempt.
 - If the CB disagrees, the cash transfer orders are rejected.

⁵² In case of blocking of a party all cash accounts of the party are handled accordingly.

- I Warehoused payment orders need to be confirmed by the responsible CB on the intended settlement day before they can run through the entry disposition. As soon as an MCA is blocked, no standing order liquidity transfer orders are generated anymore debiting the blocked cash account.
- I In case of inter-service standing order liquidity transfer orders the blocking status of the cash account to be credited is not checked by CLM. The detailed handling is up to the respective receiving settlement service.
- I Intra-service standing order liquidity transfer orders are not created in case:
 - the cash account to be debited is blocked for debits or;
 - the cash account to be credited is blocked for credits.

Note: The confirmation of cash transfer orders is done by the responsible CB via the GUI. Nevertheless, organisational rules outside CLM may be implemented to involve other bodies, depending on the legal requirements of each country, before the CB confirms the earmarked cash transfer orders.

In case a cash account is either blocked for debits or for credits only, in principle the same processing as described above does apply - but only for the relevant cash transfer orders (i.e. either debits only or credits only).

In case of unblocking, the cash account is set to unblocked status again. Consequently, all affected earmarked cash transfer orders are considered for further processing (i.e. an explicit confirmation by the responsible CB is no longer needed).

5.11 Cash Transfer Category and Business Case Codes for various features

CLM uses the following codes for various cases:

- I For message subscription, CLM sends a debit notification or credit notification to a business receiver if the account holder has subscribed for the message in CRDM. It is used to confirm the credit or debit of a certain entry on one of the account holder's CLM cash accounts.
- I For provision of entry details in [camt.053](#) [▶ 511] and [camt.054](#) [▶ 520]
- I For [cash transfer query](#) [▶ 411] and [query response](#) [▶ 434] ([camt.005](#) [▶ 411] and [camt.006](#) [▶ 434])

The following business scenarios are possible:

Code	Description	Subject to camt.054 [▶ 520] message subscription	Provided in camt.053 [▶ 511] and camt.054 [▶ 520]	Cash Transfer Category [Payment Type] provided in camt.005 [▶ 411]/ camt.006 [▶ 434]
Liquidity transfers				
LIIE ⁵³	Immediate liquidity transfer - Inter-service	Y	Y	Y
LIPU	Immediate LT – Inter-service pull	Y	Y	Y
LIIA	Immediate liquidity transfer - Intra-service	Y	Y	Y
LAUT	Automatic liquidity transfer	Y	Y	Y
LRFB	Rule-based liquidity transfer - Floor breach	Y	Y	Y
LRCB	Rule-based liquidity transfer - Ceiling breach	Y	Y	Y
LRQP	Rule-based liquidity transfer - Queued RTGS payment or AS transfer	Y	Y	Y
LSIE ⁵⁴	Standing order liquidity transfer - Inter-service	Y	Y	Y
LSIA	Standing order liquidity transfer - Intra-service	Y	Y	Y
LCCA	End of day liquidity transfer due to closing of accounts	Y	Y	Y
LCCS	Balance from Contingency Service	Y	Y	Y
CBOs				
CONP	Connected payment	Y	Y	Y
BLKD	Central Bank direct debit related to seizure of funds	Y	Y	Y
CDLN	Credit line modification	Y	N	N
OCBO	Other CBOs (e.g. Inter-CB payments)	Y	(Y) ⁵⁵	Y

53 applicable to all immediate inter-service liquidity transfers between RTGS and CLM and to all inter-service liquidity transfers generated by T2S and TIPS (immediate + standing orders)

54 applicable to all inter-service standing order liquidity transfers generated by RTGS and CLM (including those towards T2S and TIPS)

Code	Description	Subject to camt.054 [▶ 520] message subscription	Provided in camt.053 [▶ 511] and camt.054 [▶ 520]	Cash Transfer Category [Payment Type] provided in camt.005 [▶ 411]/ camt.006 [▶ 434]
	<ul style="list-style-type: none"> Any agreed code(-word) entered in the payment by CB Not validated 			
Other system-generated operations				
CCBT	EoD settlement on CB ECB Accounts	Y	Y	Y
MCBT	EoD settlement on ECB mirror accounts	Y	Y	Y
Billing				
BILI	Billing - Invoice	Y	Y	Y
Overnight deposit				
ODSU	Overnight deposit - Setting up	Y	Y	Y
ODRV	Overnight deposit - Reverse	Y	Y	Y
ODRF	Overnight deposit - Refunding	Y	Y	Y
ODIN	Overnight deposit - Interest	Y	Y	Y
Marginal lending				
AMLS	Automatic marginal lending - Setting up connected payment	Y	Y	Y
AMLR	Automatic marginal lending - Reimbursement connected payment	Y	Y	Y
MLRS	Marginal lending on request - Setting up (till ECMS go-live)	Y	Y	Y
MLRR	Marginal lending on request - Reimbursement (till ECMS go-live)	Y	Y	Y

55 Or any agreed code(-word) entered in the inbound payment order by a CB in regards CBO (i.e. other than CONP or BLKD). Such code(-word)s are not validated by CLM on content or length and are not considered for further CLM processing except [camt.053](#) [▶ 509]/[camt.054](#) [▶ 518] reporting.

Code	Description	Subject to camt.054 [▶ 520] message subscription	Provided in camt.053 [▶ 511] and camt.054 [▶ 520]	Cash Transfer Category [Payment Type] provided in camt.005 [▶ 411]/ camt.006 [▶ 434]
MLRV	Marginal lending on request - Reverse (till ECMS go-live)	Y	Y	Y
MLIN	Marginal lending interest (till ECMS go-live)	Y	Y	Y
Minimum reserve				
MRIN	Interest on minimum reserve	Y	Y	Y
MRPN	Penalty due to minimum reserve infringement	Y	Y	Y
MREX	Interest on excess reserve exemption – Tier 1	Y	Y	Y
MRER	Interest on excess reserve – Tier 2	Y	Y	Y
Interest on accounts				
IACP	Interest payment	Y	Y	Y

Table 51 - Business case description

6 Overview of used common components in CLM

TARGET Services will be supported by the following main common components: (1) Eurosystem Single Market Infrastructure Gateway (ESMIG); (2) CRDM; (3) Billing; (4) LEA and (5) BDM. In addition, some TARGET Services will have a common DWH and contingency component.

The access to the TARGET Services and components will take place via ESMIG component. It will be network provider agnostic (i.e. will not rely on network specific features) and thus allows participants to connect through a single certified NSP to access all TARGET Services both via A2A and U2A (via GUI). Different TARGET Services may finalise their migration to the common gateway at different times, including after the go-live of phase II of the T2-T2S Consolidation project. Furthermore, ISO 20022 compliant messaging will be adopted as the standard format for communication with all TARGET Services. ESMIG shall provide central authentication, authorisation and user management features to protect the connected systems/platforms against intrusion and unauthorised access and to ensure that a trusted party transmitted the inbound communication through a secure channel.

Any reference data object (or function) that is used by more than one service shall be set up and managed (or implemented) in CRDM component. Service-specific reference data objects (or functions) are set up and managed (or implemented) in the respective service. The aim of CRDM is to (1) achieve consistency and integrity of all reference data, (2) ensure consistent processing and relationships between reference data across services, and (3) avoid duplication of reference data and redundant implementation of the same functions in multiple services.

Common component for Billing will facilitate the Eurosystem to prepare and process invoices for different TARGET Services and common components.

LEA component will collect all information which is subject to LEA requirements: i.e. all incoming and outgoing business transactions from and to participants as well as relevant reports such as account statements. Moreover, some messages between different services are archived as well. The information from TARGET Services and common components will be stored in LEA in its original content and format and will be accessible within its retention period of ten years.

Data from the current business day from T2 (i.e. CLM and RTGS) and T2S is available in DWH component as of the next calendar day. DWH provides data for historical, statistical and regulatory reporting. Participants can access the DWH via A2A and U2A (via GUI). They can subscribe to predefined reports or query the database by using predefined templates.

6.1 CRDM

CRDM provides a CRDM feature that allows all CRDM Actors to create and maintain common reference data for the configuration of data related to parties, cash accounts, rules and parameters. The following list shows the main configuration areas for common reference data in CRDM:

- l party reference data;

- | cash account reference data;
- | access rights management;
- | message subscription configuration;
- | network configuration;
- | report configuration;
- | BDM configuration;
- | restriction type management;
- | Billing configuration;
- | configuration parameters⁵⁶.

CRDM Actors set up the appropriate configuration by creating and maintaining common reference data objects in CRDM. A common reference data object is a set of logically related, self-consistent information. Parties and cash accounts are examples of common reference data objects.

CRDM allows CRDM Actors to create, update and delete common reference data objects in CRDM. Deletion of a common reference data object is always on logical level and it is possible, for a duly authorised user, to restore a previously deleted common reference data object.

CRDM allows full maintenance of all reference data objects in U2A mode, whereas it provides only a sub-set of functions in A2A and Data Migration Tool (DMT) more on a limited number of reference data objects.

CRDM provides versioning facilities and validity periods allowing the implementation of data revision and data history features, in order to keep track of all past data changes, to enter changes meant to become effective as of a future date and to define common reference data objects with limited or unlimited.

All types of CRDM Actors, i.e. CBs, payment banks, AS and the operator have access to the common data management, each of them to different functions and data, according to the access rights granted to their users.

Duly authorised users can create and maintain common reference data objects in CRDM submitting common reference data maintenance instructions.

Further details on CRDM can be found in the CRDM UDFS.

6.2 Data Warehouse

This chapter provides an overview as regards the DWH and the interaction of this common component with CLM.

⁵⁶ This area includes reference data for countries, currencies, currency service links, system entities, services, BIC directory and reserve management parameters.

6.2.1 Functional overview

The DWH is a common component collecting business information and data derived from CLM and other settlement services and (common) components. The DWH supports business decisions by allowing data consolidation, data preparation and reporting at different aggregation levels.

The collected information from CLM includes the following:

- | account balances;
- | cash transfer order and cash transfer information;
- | settlement related information (including warehoused payment orders, earliest/latest debit time indicator and other factors influencing the settlement of cash transfer orders);
- | liquidity reservations;
- | settlement restrictions (blocking of accounts/parties);
- | minimum reserve information;
- | standing facility information;
- | credit line and intraday credit data;
- | account data (including CLM specific reference data);
- | messages.

The collected information is kept for ten years within the DWH.

Besides this information from CLM, data from RTGS, T2S⁵⁷, CRDM, Billing, the Contingency Service (only in case it was opened) and the component managing the business day is available in the DWH as well.

The data is transmitted to the DWH from the settlement services and (common) components at the end of each business day. After the processing (data transformation and pre-calculations) of the transmitted data within the DWH, data of the previous business day is normally available in the DWH as of the start of the new calendar day.

Both communication modes (A2A and U2A) are available for the DWH via ESMIG. With the A2A interface, DWH users can receive (predefined) reports on the basis of a prior configuration (in U2A mode). For detailed information on the DWH communication in A2A mode and the configuration to receive (predefined) reports, see the DWH UDFS, chapter "*Overview > DWH communication*".

To enable the access to the DWH via U2A mode, a GUI (DWH GUI) is available. The DWH GUI gives a business-oriented view of the collected data and offers the possibility to export data results which are shown on the GUI screen to different formats. For detailed information on the DWH GUI including, e.g. the way of presentation of data in the DWH, the data structure and possible filter criteria see the DWH documentation (UHB).

57 T2S data will be available in the DWH as soon as the T2S Long Term Statistical Information (LTSI) component has been decommissioned.

The DWH offers different types of reports. The DWH normal user profile grants access to a set of predefined reports. The advanced user profile (only applicable for CBs) in addition offers the possibility to adapt predefined reports and to freely design new reports using the data objects available in the DWH (user defined reports).

The data access/scope within the DWH depends on which settlement services/components are used by a system entity/party. For CLM users the DWH is available for CBs, payment banks and AS. Authorised DWH users can access their data according to their access rights and their own data scope.

Further details on DWH can be found in the DWH UDFS.

6.2.2 Interaction with CLM

As far as CLM data is within the scope of the DWH, the data of each CLM business day is transmitted from CLM to the DWH once per business day. As soon as all EoD processes with an impact on the CLM data for the respective business day have been finished and the CLM event CCOS (CLM "EoD – close of service") is reached, the CLM data from the respective business day is copied from the CLM operational database to a replication database in the DWH using an internal technical communication channel. As a consequence, the following process steps within the DWH require no more direct interaction with the CLM operational database and the business day change in CLM is independent from these activities.

Once the transmission process has been finished, further processes (data transformation and data pre-calculation) within the DWH are performed using the CLM data. For detailed information on these processes, see the DWH documentation (UDFS).

The following diagram shows a conceptual overview of the interaction between CLM and the DWH:

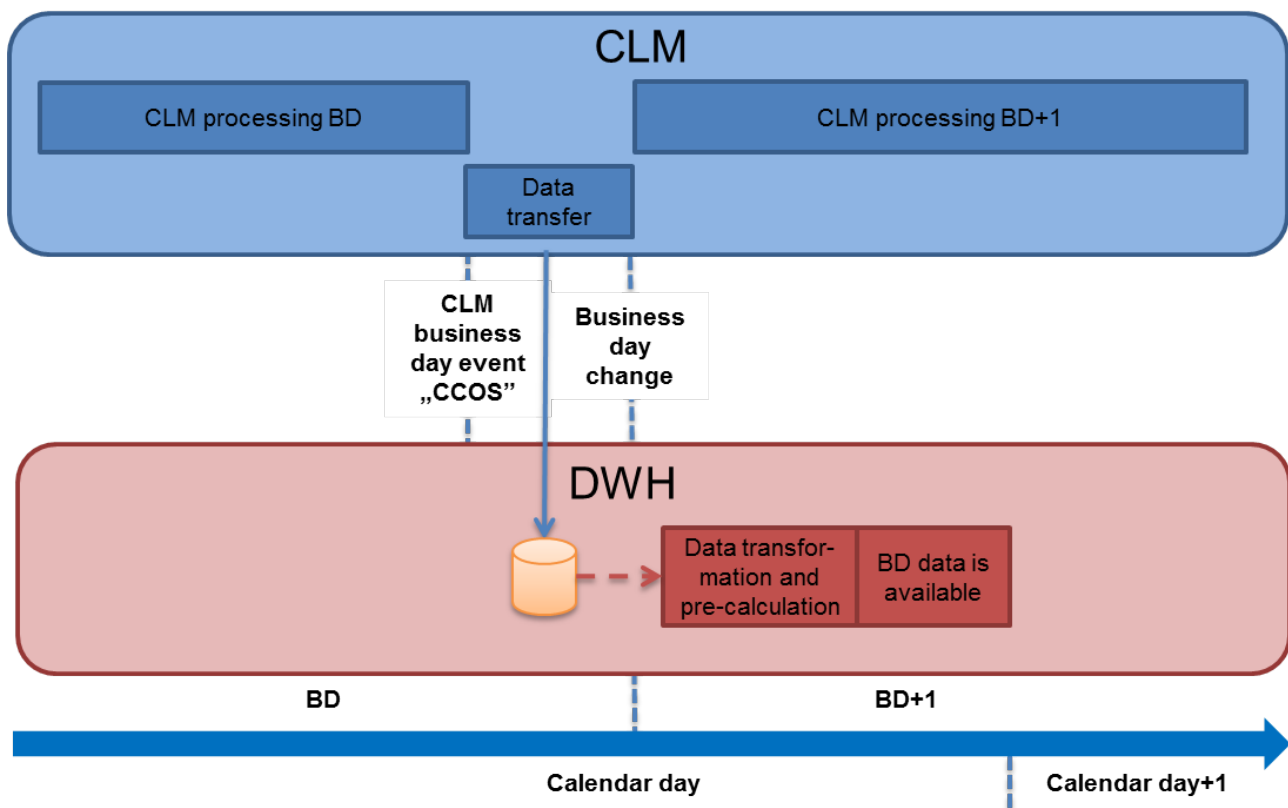

Figure 36 - Interaction between CLM and DWH

6.3 Billing

The Billing common component provides the functionalities for the aggregation of the daily billable items, its enrichment into invoice data and the centralised creation and management of invoices for all the TARGET Services.

The involved actors and their relevant activities are:

- | the operator monitors the correct functioning of Billing and is responsible for the invoice creation and sending and, in exceptional circumstances, for the cancellation of the invoices;
- | the ECB actor manages the invoices to be issued to the CBs – including the possibilities to insert manual corrections at system entity level;
- | the CB actor can:
 - optionally receive consumption messages;
 - receive its own invoices via A2A;
 - access the system and query invoice data of its participants and manage manual corrections for the participants' invoices;
 - access the system and view/download the created invoices (its own as system entity and the ones of its participants) in PDF format;

- optionally configure direct invoicing (i.e. direct sending of XML invoice from Billing to participant);
- optionally configure direct debiting for the payments of its participants' invoices.

Each CB Participant can, if configured by the relevant CB, receive its invoices via A2A and receive a direct debit on its account in order to pay the fees.

Further details on Billing can be found in the Billing UDFS.

6.4 Legal Archiving

6.4.1 Legal Archiving management

The operator is responsible for the retrieval of the archived information upon CB request. The CB can also request the retrieval of archived data on behalf of one of their participants.

The operator is allowed to retrieve archived data that belong to the predefined retention period.

6.4.2 General features of Legal Archiving

The LEA common component provides features to gather all information which is subject to LEA requirements from all the Eurosystem Market Infrastructure Services. LEA archives messages for all TARGET Services. The messages exchanged via ESMIG (i.e. between the Eurosystem and parties external to ESMIG) and some messages between different services – so-called internal messages - are archived.

All external communication is provided by ESMIG to LEA. In addition, the following internal message exchanges are provided by CLM (via DWH) for Legal Archiving:

- l Camt.050/camt.025 –sent by RTGS to CLM
- l Camt.050/camt.025 –sent by T2S to CLM
- l Camt.050/camt.025 – sent by TIPS (Adapter) to CLM
- l Pacs.009/pacs.010 – sent by ECMS to CLM
- l Camt.056 – sent by ECMS to CLM
- l Camt.998 – sent by ECMS to CLM

Messages sent by CLM to RTGS, T2S or ECMS are provided by the receiving settlement service to Legal Archiving.

Legally archived messages are retained for a predefined retention period, which may be different for different services. The retention period for CLM is ten years. The information is stored and managed in a centralised way and in their original format.

At the end of each business day, all data relevant for legal purpose produced by the services are sent to the LEA component. LEA is mainly concerning settlement-related messages and messages changing reference data or transactional data.

6.5 ESMIG

The description of the ESMIG included in this document is related to the network connectivity services provided by ESMIG to all the TARGET Services, common components and applications. In the context of the market infrastructure services' consolidation, ESMIG will also provide differentiated and additional services based on the needs of the others Eurosystem Market Infrastructure Services.

When possible, synergies between ESMIG provided features across the different TARGET Services, common components and applications have to be put in place. ESMIG offers scalability to cope with the different TARGET Services, common components and applications throughputs and it ensures that the traffic of one backend service may not impact the processing time of messages from or to other services. In the context of the current document, ESMIG provides to actors the single access point for the external communication to TARGET Services, common components and applications. This means it is in charge of A2A and U2A traffic management providing authentication of all inbound traffic (A2A and U2A).

ESMIG provides business continuity measures (e.g. multiple sites, path diversification, etc.) and PKI Services. Moreover ESMIG provides operational/monitoring tools to ensure the monitoring of the system's functioning by the Operator Service Desk.

The ESMIG opening hours are aligned with the opening hours of the respective market infrastructure services, e.g. for TIPS it is 24/7/365.

ESMIG is expected to perform basic checks on inbound messages and then route them to the relevant TARGET Services, common components and applications. Similarly, ESMIG takes care of the routing of outbound messages from TARGET Services, common components and applications to the related NSP.

ESMIG, for some validations making use of services offered by the NSPs, is expected to:

- | authenticate the message sender;
- | check that the sender belongs to the Closed Group of Users (CGU) entitled to send messages to the relevant TARGET Services, common components and applications;
- | execute the technical validation of the received messages (well-formedness of the XML) at transport level;
- | perform the schema validation, in case the backend component requires it (compliance of the incoming A2A message with the referenced XML schema definition - e.g. it checks that the message contains all the mandatory fields, that the value of each field is consistent with the data type of the field, etc.);
- | provide digital signature services;
- | forward the message to TARGET Services, common components and applications along with the technical sender's DN.

Further details on ESMIG can be found in the ESMIG UDFS.

6.6 Business Day Management

In the CRDM it is possible to define, for each relevant service or component, operating day types as default sets of events with specific planned execution times, predecessor dependencies, and specific processes to be activated for each event.

At business date change, the proper operating day type is loaded from the CRDM to the BDM common component; this allows the automated generation of the current business day schedule (scheduler list) for each service or component upon SoD.

BDM manages the scheduler lists generated starting from the CRDM.

For each service or component, calendar data includes the opening days (with specific operating day types) and closing days that can optionally be defined as currency-based. The maintenance of operating day type and calendar elements is performed in the CRDM common component.

Modifications to the operating day type structure are made effective after being loaded in the scheduler list.

Further details on BDM can be found in the BDM UDFS.

6.7 Contingency Services

Contingency Services for T2, called ECONS II (Enhanced Contingency Solution) aim at addressing a situation where the T2 Service (i.e. CLM and RTGS) is not available due to a major technical failure or a successful cyber-attack, which may not allow for a recovery of T2 in another site or region. In such circumstances, ECONS II allows to resume the processing of critical transactions for a period of up to five consecutive business days.

The settlement of transactions in a contingency case is performed on technical accounts dedicated for contingency settlement, having a starting balance of zero. Contingency settlement allows Central CBs to provide liquidity (debiting its own account and crediting the account of a participant) in A2A mode based on collateral available in a CMS or in U2A mode via GUI.

Contingency settlement supports an AS settlement procedure A with the restrictions as described in the ECONS II UDFS, chapter "*Settlement of AS Transaction files*".

It is ensured that the contingency activities are traceable (e.g. through specific transaction reference numbers) and reconcilable with the production CLM and RTGS after recovery. The contingency settlement is complementary to and independent from the production system, and it can run in parallel with the latter.

ECONS II for T2 is i) connected to the common components (ESMIG, CRDM, LEA), and ii) technologically diverse from the main T2 Services. The contingency settlement has its own fully segregated ESMIG components.

Further details on ECONS II can be found in the ECONS II UDFS.

7 Operations and support

7.1 Business application configuration

The configuration of the TARGET Services, specific components, common components and applications is performed by means of a set of rules and parameters. These rules and parameters are defined and maintained exclusively by the Operator Service Desk as reference data objects.

7.2 Business and operations monitoring

The business and operations monitoring integrates information coming from different sources in order to monitor the business and operational status of the platform, to detect possible problems in real-time and to provide up-to-date information in the event of an incident scenario. Monitoring is the activity related to the control of the platform functioning and to the immediate awareness of any event possibly impacting on it. The monitoring is a prominent task of the Operator Service Desk who monitors the TARGET Service infrastructure, the specific components and the common components continuously, thus allowing an immediate detection of possible deviations from the standard behaviour.

In case an action can be taken directly in order to either remove the problem or to anyway restore the normal situation, the Operator Service Desk does it autonomously within the agreed internal procedures. Should this be not the case, the Operator Service Desk raises the alarm through the standard procedures to be defined in the Operational Procedures Documentation.

7.3 Trouble management

The Trouble Management System (TMS) is a tool where the Operator Service Desk tracks all interactions with the authorised TARGET Service Actors. Following the naming convention of the Information Technology Infrastructure Library (ITIL) used in the TARGET Services, events captured in the TMS can be:

- | incidents;
- | problems;
- | service requests.

The authorised TARGET Service Actors are able to report anomalies or to submit a request via telephone or e-mail to the Operator Service Desk. They receive an identifier through which they have the possibility to get updates on the case through the TMS interface.

The TARGET Service Actor in whose name the case is opened is entitled to access the related item in the TMS through a dedicated interface which is made available to it. The key to retrieve the information is the

case number which the reporting actor is provided immediately when calling or via a return e-mail, should the latter be the way of getting in touch with the Operator Service Desk.

Each item within the TMS has a life cycle from the opening until the closure through updates and status changes. Every time the case is impacted by one of such events, the concerned TARGET Service Actor receives a notification where it is invited to have a look at the case. An agreement from the reporting TARGET Service Actor is required to close a TMS case.

8 Additional information for CBs

8.1 Role of CBs in CLM

General

The relationship between the CBs and their national banking communities remains decentralised. The principle of a centralised platform enables the CBs to provide harmonised and cost-efficient services to their counterparties.

Each CB remains fully responsible for the business relations with its CLM Account Holders. Therefore, the system is designed in a "client-based" way in order to meet the administrative and monitoring requirements of the participating CBs.

Tasks of the CBs

In the context of CLM, the CBs have the following tasks:

Administrative tasks	Operational tasks
Reference data set-up and maintenance in CRDM	All contacts and provision of any kind of support to their CLM Account Holders
	Blocking and unblocking of parties/accounts
	Monitoring of the activities of their CLM Account Holders
	Provision of intraday liquidity necessary for the smooth running of the system
	Initiating cash transfer orders on their own
	Initiating liquidity transfer orders on behalf of their CLM Account Holders
	Billing to their CLM Account Holders
	Handling of local contingency
	Minimum reserve management
	Processing of standing facilities

Table 52 - Tasks of the CBs

Note: Eurosystem Central Banks can use different accounts for different types of interest: CB accounts for standing facilities interests, CB accounts for minimum reserve interests and penalties and CB accounts for other interests.

8.2 Processing of cash transfer orders - specific functions for CBs

8.2.1 Functions in relation to their community

CBs have specific functions, only applicable to them. These include queries on activities and liquidity of the parties they are responsible for (see chapter [Query management - CB specific queries](#) [▶ 200]) and specific actions in case of e.g. blocked accounts/parties.

The following specific actions are applicable for CBs in CLM (in U2A only) in relation to their community:

- | agree/disagree on cash transfer orders related to blocked parties/accounts;
- | create operations-related broadcasts.

Further details on the U2A functionalities are provided in the CLM UHB.

In contingency situations on the side of a CLM Account Holder, a CB can support its CLM Account Holder by initiating liquidity transfer orders on behalf.

8.2.2 Central bank operations

A CB can send cash transfer orders related to CBOs (except those which are generated by the system) depending on the underlying business case as:

- | [FinancialInstitutionCreditTransfer \(pacs.009\)](#) [▶ 624]
- | [FinancialInstitutionDirectDebit \(pacs.010\)](#) [▶ 633];
- | [LiquidityCreditTransfer \(camt.050\)](#). [▶ 505]

Updates of credit lines are also CBOs, but in this case a [ModifyCreditLine \(camt.998\) - specific for CBs](#) [▶ 580] message has to be used and no cash transfer order. Further details on CBOs are provided in chapter [Processing of CBOs](#) [▶ 95].

Depending on the type of operation, the CB can send payment orders to either debit or credit the MCA of a CLM Account Holder and to credit/debit an account of the CB as counterpart. The CB has the right to direct debit any MCA of its community without needing a direct debit mandate. A CB requires a direct debit mandate in order to debit the MCA of a CLM Account Holder of another CB. Also credit transfers between two different CBs are possible (e.g. inter-CB payments).

The CB can send credit transfer orders and direct debit orders also as connected payment orders. Further details can be found in chapter [Connected payment](#) [▶ 191].

Note: Payment orders are either fully executed or queued, i.e. payment orders are never settled partially. Connected payment orders are never queued.

Payment orders can be initiated by the CB in A2A mode.

A CLM Repository is available for the CBs containing CLM MCA information to support the initiation of CBOs by a CB. Further details can be found in the CRDM UDFS, chapter “*CLM Repository*”.

Within the payment order, CBs have the possibility to define the execution time ([Definition of execution time](#) [▶ 98]). It is possible to set:

- | an “earliest debit time indicator” (FromTime);
- | a “latest debit time indicator” (RejectTime).

Furthermore, payment orders can be submitted as “warehoused payments” which means that the CBO is sent up to ten calendar days in advance. In this case, the payment order is warehoused until CLM opens for the settlement on the intended settlement day (see chapter [Warehoused payment orders](#) [▶ 100] and Table 14 - [Attributes of the warehoused payment period](#) [▶ 71]).

Payment orders not yet finally processed can be modified or revoked by the CB.

With the exception of credit line updates and standing facilities, CBOs are processed between the business day events “Start of CLM RTS” and “Cut-off for CLM RTS”, interrupted by the maintenance window, if activated. Further details on the business day are provided in chapter [Business day](#) [▶ 73].

Further details on credit line updates are provided in chapter [Credit line modifications](#) [▶ 190].

8.2.3 Seizure of funds

Based on court decision(s), a CB might be obliged to reserve liquidity on the MCA of a CLM Account Holder dedicated for seizure. CLM offers standardised functionality to handle the blocking of a certain amount of liquidity on the MCA in case of seizure.

The blocking of a dedicated amount of liquidity in case of seizure is achieved through a special reservation functionality which is available for CBs only. Further details on the processing are provided in chapter [Liquidity reservation](#) [▶ 130] and [Manage current reservation in CLM](#) [▶ 253].

The seizure of funds reservation ensures that the respective amount is no longer available for the settlement of cash transfer orders or credit line modifications. Only the CB is allowed to transfer the respective amount from the MCA to another cash account in CLM by using a direct debit payment order with a dedicated codeword (“BLKD”). The seized amount can also be modified or completely released by the CB via the standardised functionality, once it has been set up.

Note: Although the seized amount is not available for settlement of cash transfer orders or credit line modifications, the seized funds are included in the minimum reserve calculation. In case the seized amount shall not be taken into account for minimum reserve calculation, the CB needs:

- | to adjust the aggregated EoD balance to be considered for the fulfilment of the minimum reserve requirement by sending an adjustment with the respective delta amount in A2A or U2A for the affected day(s). Further details on this functionality are provided in chapter [Insert or adjust balance for minimum reserve fulfilment](#) [▶ 202];

- | to transfer the respective amount to a cash account not considered in the minimum reserve calculation.

Further details on the U2A functionality will be provided in the CLM UHB, chapter "*Liquidity Management Features*".

8.3 Credit line management

A CB can manage the credit lines of its CLM Account Holders by using:

- | credit line modifications;
- | connected payments.

8.3.1 Credit line modifications

Credit lines can be defined, modified or deleted in A2A mode (by sending a [ModifyCreditLine \(camt.998\) - specific for CBs](#) [▶ 580] message via the local CMS⁵⁸) or U2A mode (via a dedicated screen)

Two types of orders for modifying a credit line exist:

- | fixed amount credit line orders containing the new value of the credit in absolute figure (which can only be a positive amount or zero);
- | delta amount credit line orders containing the delta between the new and the old credit line value.

Both types should generally not be used in parallel. Otherwise, the following restrictions apply for parallel usage.

- | Pending fixed amount decrease orders are rejected if any new credit line order (fixed or delta) or a connected payment order, which can be immediately settled, is submitted.
- | Several delta amount orders can be pending in parallel. It means that these orders are accepted and are placed in the queue one after the other, but all pending delta amount orders for one MCA are rejected if a fixed amount order is submitted.
- | If the credit line is already used, an order to reduce the credit line is pending in case of insufficient available liquidity.

Payment order processing principles do not apply to credit lines: e.g. pending credit line changes bypass FIFO principle and are placed on the top of the queue and pending credit lines cannot be moved from the first position in the payment order queue to the last one (i.e. no re-ordering).

Changes to the credit line are in general possible throughout the whole business day. The only exceptions are the times between business day events "CB cut-off for standing facilities" and the "Start of CLM RTS" on the new business day, as well the time during the maintenance window.

58 Credit line modifications in EUR using [ModifyCreditLine \(camt.998\)](#) [▶ 578] from local CMS are only allowed until ECMS go-live.

Further details on the credit line management are provided in chapter [Modify credit line](#) [▶ 247].

8.3.2 Connected payment

A connected payment is a payment order initiated by the local CMS⁵⁹ of the responsible CB. It can be used to trigger a change of the credit line and the parallel settlement of a payment amount on the same MCA. In case of a “pure” credit line change, the amount indicated in the connected payment is zero.

The processing of connected payment orders is in general possible throughout the whole business day. The only exceptions are the times between business day events “CB cut-off for standing facilities” and the “Start of CLM RTS” on the new business day, as well the time during the maintenance window.

Further details on the business day are provided in chapter [Business day](#) [▶ 73].

Note: Connected payments are not queued and can therefore not be revoked. In case of insufficient liquidity, this payment type is immediately rejected. If a connected payment is settled, any already pending fixed amount credit line modification is rejected. A connected payment order decreasing the available liquidity is rejected, if a delta amount credit line modification is already pending.

Connected payment orders decreasing the available liquidity are able to breach the FIFO-principle, if the available liquidity is sufficient for the settlement of this order and no delta amount order to decrease the credit line is pending.

A connected payment order can only be settled if the available liquidity of an MCA is still positive after the liquidity change due to the connected payment. The liquidity change is the sum of the balance change and the credit line change. Consequently, a connected payment with a balance decrease of “10” and a credit line increase of only “5” results in a liquidity change of “-5” and is therefore not possible on an MCA with a previous available liquidity of “0” (i.e. the available liquidity would be negative after the connected payment execution and thus the validation fails).

To decrease a credit line, a [FinancialInstitutionCreditTransfer \(pacs.009\)](#) [▶ 624] message is used.

To increase a credit line, a [FinancialInstitutionDirectDebit \(pacs.010\)](#) [▶ 633] message is used.

Further details on the processing of connected payment orders are provided in chapter [Processing of CBOs](#) [▶ 95].

⁵⁹ With the implementation of ECMS, local collateral management systems will no longer exist and therefore there is no longer a business case for connected payments to update the credit line by CBs.

8.4 TARGET Services general ledgers

For accounting purposes, each CB needs information on the cash accounts it is responsible for at the EoD. The general ledgers provide all the necessary information to each CB to update the internal accounting system and to generate the daily balance sheet.

8.4.1 Collection of general ledger data and sending to CBs by CLM

During the EoD procedure, the general ledger processing in CLM is done in three steps:

1. collection of the general ledger data from settlement services other than CLM (RTGS, TIPS, T2S);
2. collection of general ledger data for CLM cash accounts;
3. sending the collected data in settlement service-specific general ledgers to each CB.

These processing steps run in parallel as far as possible, since receipt, validation and forwarding of the general ledgers of each settlement service are independent of using them in the overall calculations in CLM EoD processing.

Collection of the general ledger data from settlement services other than CLM

First, CLM ensures with all settlement services, that no liquidity transfer order is pending between CLM and the respective settlement service. Afterwards, CLM requests the sending of the general ledgers from each settlement service and receives the general ledger data from the other settlement services (i.e. one general ledger per settlement service and currency) containing:

- l cash account number;
- l SoD and EoD balances of the cash accounts;
- l debit and credit turnover on the cash accounts.

Each settlement service provides for each currency in which it settles on cash accounts a general ledger to CLM. In case a currency is not subject to settlement in CLM, no general ledger is requested by CLM from the respective settlement service.

In principle, only active cash accounts are reported. However, if a turnover took place on an account before it was closed on that business day, closed accounts are also reported.⁶⁰ An exhaustive list of cash account types per settlement service which are reported in the respective TARGET Services general ledgers is provided in Table 53 - [List of account types in the respective settlement service-specific general ledger](#) [▶ 195].

When receiving the general ledgers from the different settlement services, CLM performs the following consistency checks for each general ledger:

⁶⁰ Closed cash accounts are reported in the general ledger sent by RTGS on the day they were closed with a balance of zero, as any remaining EoD balances on cash accounts to be closed in RTGS will have been transferred to the RTGS CB Account of the responsible CB.

- | each reported EoD cash account balance is checked by adding all turnovers of the respective cash account to the SoD balance of the respective cash account, which must again give the EoD cash account balance;
- | the sum of all EoD cash account balances of the respective settlement service held in the same currency (excluding the dedicated transit account for this currency) must be equal to the balance of the dedicated transit account for this currency held in CLM for the respective settlement service;
- | the balance of the dedicated transit accounts held in CLM for the respective settlement service and the balance of the dedicated transit account (e.g. RTGS dedicated transit account) held in the respective settlement service with the opposite credit/debit indicator must be equal.

The general ledger information provided by the settlement services is also taken into account for the following EoD operations in CLM:

- | [Automatic marginal lending](#) [▶ 149] calculations⁶¹;
- | [Minimum reserve management and interest calculation](#) [▶ 139] on accounts;
- | [Cross-CB turnover](#) [▶ 197] calculations.

In case a settlement service cannot provide the general ledger, an alert is sent to the operator. In case the general ledger provided is inconsistent, an alert is sent to the operator and the holder of the transit account of the impacted settlement service. In both cases dedicated contingency measures are applied on operational level.

Note: In case the general ledger from one settlement service is not available and it has been decided on operational side⁶² to skip the processing of the general ledger for a single settlement service in order to proceed with the EoD, the EoD processing goes ahead without having the cash account balances of the respective settlement service available for this business day. In this case, the general ledger information of the respective settlement service cannot be considered in the above-mentioned calculations in CLM EoD.

Collection of general ledger data for CLM cash accounts

During the EoD period (for further details see chapter [End-of-day period \(18:00 - 18:45 CET\)](#) [▶ 87]), the settlement of

- | calculated cross-CB turnover per settlement service and
- | automatic marginal lending – based on the information provided by the other settlement services takes place.

Once the settlement processes in CLM are finalised, CLM collects for all cash accounts in CLM the following data:

- | cash account number;

61 After ECMS go-live ECMS will communicate to accounting the usage of all operations, including the marginal lending on request and the automatic marginal lending.

62 The detailed procedures to be applied in case of contingency situations are not part of the UDFS.

- | SoD and EoD balances of the cash accounts;
- | debit and credit turnover on the cash accounts.

Only active CLM cash accounts are reported.⁶³ An exhaustive list of CLM Account types which are present in the settlement service-specific general ledgers is provided in Table 53 - [List of account types in the respective settlement service-specific general ledger](#) [▶ 195].

In addition to the CLM cash account balances and turnovers, the EoD postings on the CBs' ECB accounts and ECB mirror accounts stemming from the cross-CB turnover calculations are retrieved from the database.

Further details on the cross-CB turnover calculations and postings can be found in chapter [Cross-CB turnover](#) [▶ 197].

Sending the collected data in settlement service-specific general ledgers to each CB

Immediately after receiving and validating the relevant general ledger data of the individual settlement services (incl. CLM), CLM builds for each settlement service a service-specific general ledger per CB and currency. Finally, it sends every general ledger to the CBs using the structured ISO format [General ledger \(camt.053\)](#) [▶ 567] message.

8.4.2 Content of TARGET Services general ledgers

The settlement service-specific general ledgers provided by CLM to each CB contains all cash accounts held in the respective settlement service.

In general, the following information is provided in each settlement service-specific general ledger for all cash accounts of the relevant settlement services per CB and currency:

- | identification of the settlement service of the cash account;
- | account number;
- | account owner BIC;
- | account currency;
- | balance SoD;
- | total turnover debit;
- | total turnover credit;
- | balance EoD.

Note: The information listed above is also provided for the CB ECB accounts in CLM (only relevant for all CBs with currency Euro) and the ECB mirror accounts in CLM (relevant for the ECB only).

⁶³ Closed cash accounts are not reported in the general ledger files sent by CLM as any remaining EoD balances on cash accounts to be closed in CLM will be transferred to the CLM CB Account of the responsible CB.

In CLM general ledger for the Euro, additional information is provided to each CB with regard to the CB ECB account concerning the related cross-border turnover postings. Further details on the cross-CB turnover calculations and postings can be found in chapter [Cross-CB turnover](#) [▶ 197].

Each multilateral cross-CB turnover stemming from the EoD calculation and posting process in CLM is provided per settlement service in CLM general ledger with the following information:

- l identification of the settlement service related to the multilateral turnover;
- l debit or credit posting for multilateral turnover between CB and Eurosystem/ECB;
- l country code of CB counterpart.

For the CLM general ledger of each CB for the Euro this implies one entry per settlement service (always towards ECB).

For the CLM general ledger of the ECB this implies one entry per settlement service and CB (i.e. one entry per CB offering the settlement service in Euro).

Note: In case no cross-CB turnover took place, no entry for the respective settlement service cross-CB turnover is present in CLM general ledger sent to the respective CB.

The following cash account types are reported in the general ledger for the respective settlement service:

Settlement service	Account type
CLM	MCA
	CLM CB Account
	Overnight deposit account
	Marginal lending account
	CB ECB account
	ECB mirror account (ECB only)
	CLM dedicated transit accounts (ECB only ⁶⁴)
	CLM technical account for ECONS II
RTGS	RTGS DCA
	RTGS sub-account
	RTGS CB Account
	AS guarantee funds account
	AS technical account

64 In case of the Euro.

Settlement service	Account type
	Dedicated transit account in RTGS (ECB only ⁶⁵)
TIPS	TIPS Account
	TIPS AS Technical Account
	Dedicated transit account in TIPS (ECB only ⁶⁶)
T2S	T2S DCA
	T2S CB Account
	Dedicated transit account in T2S (ECB only ⁶⁷)

Table 53 - List of account types in the respective settlement service-specific general ledger

8.4.3 General ledger provisioning and format

The sending of all settlement service-specific general ledgers to the CBs is mandatory. Therefore, no report configuration for the general ledgers is maintained in CRDM.

However, the general ledger provision follows the defined standards of report management; only the report configuration is not necessary. See chapter [Report generation process](#) [▶ 162] for the details on report management.

CLM generates a settlement service-specific general ledger per CB and per currency including the general ledger information of the respective settlement service. The provisioning starts:

- l for settlement services other than CLM, immediately after the receipt from the respective settlement service and the validation in CLM;
- l for CLM, immediately after the finalisation of the automatic marginal lending processing.

Further details on the timeline can be found in chapter [End-of-day period \(18:00 - 18:45 CET\)](#) [▶ 87].

The settlement service-specific general ledgers are provided in a structured ISO format XML message, i.e. a [General ledger \(camt.053\)](#) [▶ 567]. Further details on the message format and examples can be found in chapter [General ledger \(camt.053\)](#) [▶ 567].

65 In case of the Euro.

66 In case of the Euro.

67 In case of the Euro.

8.5 Cross-CB turnover

8.5.1 Overview

For Euro currency only, each CB has a “CB ECB account“ in CLM (including the ECB).

The CB ECB account held by each CB in CLM is debited or credited at the end of the day as part of an automated procedure. The postings on this account reflect the daily activities of each CB and its “local“ community as a result of the multilateral cross-CB turnover the CB and its parties have performed during the business day in the respective settlement service. The final EoD balance of the CB ECB account represents the total multilateral TARGET Services position (claim or obligation) of each CB towards the ECB.

The ECB has a mirror account for each CB in CLM on which the postings done on the CB ECB accounts are “mirrored“.

Note: There is no specific behaviour with regard to out-CBs, i.e. also for out-CBs a CB ECB account and an ECB mirror account is available and multilateral cross-border turnover is calculated.

8.5.2 Calculation of multilateral turnover

During the EoD processing of CLM the multilateral turnover per settlement service is calculated for each CB. Further details on the EoD processing can be found in chapter [End-of-day period \(18:00 - 18:45 CET\)](#) [▶ 87].

For each settlement service the calculation in CLM is done as follows:

The delta (= day ‘D’ minus day ‘D-1’) of the sum of the EoD balances of all Euro cash accounts per settlement service in the books of the respective CB is calculated for each CB.

After the calculation, every calculated multilateral turnover is settled on the CB ECB account of the respective CB and on the CB ECB account of the ECB. The account to be debited and the account to be credited depend on the leading sign of the delta:

- I In case of a positive delta, i.e. the sum of the EoD balances increased, the CB ECB account of the respective CB is debited and the CB ECB account of the ECB is credited.
- I In case of a negative delta, i.e. the sum of the EoD balances decreased, the CB ECB account of the ECB is debited and the CB ECB account of the respective CB is credited.

Each settlement is mirrored on the related ECB mirror accounts.

The final EoD balance of the CB ECB account, i.e. after all cross-CB turnover calculations and related posting are settled for all settlement services, represents the total multilateral TARGET Services position of each CB towards the Eurosystem/ECB.

On an optional basis, a CB and the ECB can receive individual notifications of credit or debit ([BankToCustomerDebitCreditNotification \(camt.054\)](#) [▶ 520]) for each settlement on the CB ECB accounts and the ECB mirror accounts.

All multilateral turnovers (i.e. all the single postings) are reflected per settlement service in the CLM general ledger of the respective CB and the ECB. Further details can be found in chapter [TARGET Services general ledgers](#) [▶ 192].

In case no cross-CB turnover took place (i.e. delta = 0) no posting for the respective settlement service cross-CB turnover takes place.

8.5.3 Numeric examples

In this chapter a numeric example for the calculation of the cross-CB turnover is provided for the settlement service TIPS. In principle, this example is applicable to all other settlement services.

The example includes five credit institutions (assigned to three different CBs) participating in TIPS. The figures in the columns of the table show the settled items resulting from cash transfers in TIPS (debtor: -, creditor: +):

		Transactions on TIPS side				
		Bank A	Bank B	Bank C	Bank D	Bank E
Previous business day (D-1)	responsible Central Bank	CB 1	CB 1	CB 2	CB 2	CB 3
	Closing balance	55	200	20	60	35
	∑ of all closing balances per CB	255		80		35
Current business day (D)		+20			-20	
			-80	+80		
		-10				+10
			+25	-25		
					-15	+15
	Closing balance	65	145	75	25	60
	∑ of all closing balances per CB	210		100		60

Figure 37 - Transactions settled in TIPS and related EoD balances

At the end of the business day, TIPS sends its general ledger to CLM for all the CBs participating in TIPS.

CLM calculates the delta of the sum of the EoD balances of all accounts in TIPS in the books of the respective CB on day D compared to day D-1 for each CB towards the Eurosystem/ECB. This delta is settled in CLM on the CB ECB accounts and it is “mirrored” on the ECB mirror accounts.

The delta is calculated as follows:

- | sum of closing balances of all the TIPS Accounts in the books of CB 1 on current business day compared to previous business day decreased by 45;
- | sum of closing balances of all the TIPS Accounts in the books of CB 2 on current business day compared to previous business day increased by 20;
- | sum of closing balances of all the TIPS Accounts in the books of CB 3 on current business day compared to previous business day increased by 25.

The posting on CB ECB accounts in CLM takes place as follows:

- | CB ECB account of CB 1 is credited with 45 and CB ECB account of ECB is debited with 45;
- | CB ECB account of CB 2 is debited with 20 and CB ECB account of ECB is credited with 20;
- | CB ECB account of CB 3 is debited with 25 and CB ECB account of ECB is credited with 25.

CB ECB accounts			
CB ECB account (CB1)	CB ECB account (CB2)	CB ECB account (CB3)	CB ECB account (ECB)
1) 45	2) 20	3) 25	1) 45 2) 20 3) 25

Figure 38 - Cross-CB turnover settlement on CB ECB accounts

The posting on ECB mirror accounts takes place as follows:

- | the ECB mirror account for CB 1 is debited with 45 and the ECB mirror account for ECB is credited with 45;
- | the ECB mirror account for CB 2 is credited with 20 and the ECB mirror account for ECB is debited with 20;
- | the ECB mirror account for CB 3 is credited with 25 and the ECB mirror account for ECB is debited with 25.

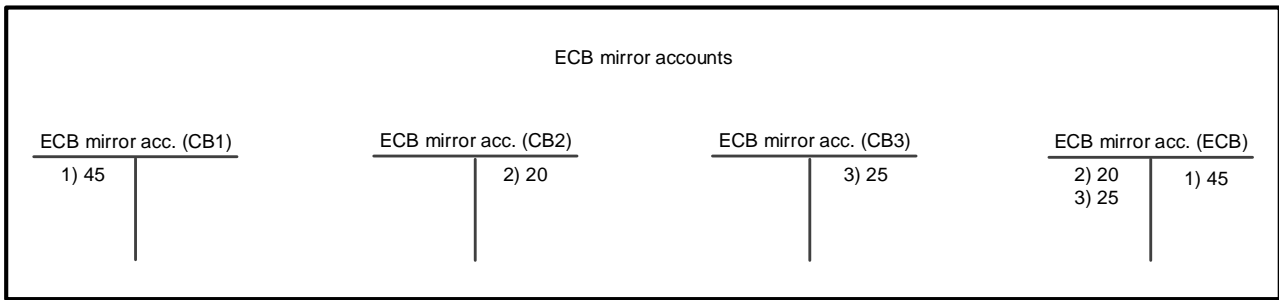

Figure 39 - Settlement on ECB mirror accounts

8.6 Query management - CB specific queries

Dedicated queries are provided to CBs in order to satisfy their specific information needs. Nonetheless, the same processing applies to all queries independent of their availability for all parties or limitation to specific parties according to their access rights (see chapter [Query management for CLM](#) [▶ 164]). As regards the processing the description in chapter [Send CLM query](#) [▶ 297] also applies for all queries irrespective of their access limitations.

Query type	Initiation via GUI (U2A mode)	Initiation via XML message (A2A mode)
Aggregated available liquidity in CLM for the whole banking community query	X	-
Aggregated liquidity for all cash accounts query (only for crisis managers)	X	-
Balances of all CLM dedicated transit accounts query	X	-
Business life cycle query	X	-
General Ledger query	-	X
Liquidity on Banking Group level query	X	-
Liquidity on Banking Group level query (activated only upon crisis managers decision)	X	-
Minimum reserve requirements query	X	X
Minimum reserve of a banking community query	X	X ⁶⁸
Cash transfers per status for the whole banking community query	X	-
Penalty query	X	X

68 In case a CB wants to receive data for its banking community, only the respective request type codes shall be used without further search criteria.

Query type	Initiation via GUI (U2A mode)	Initiation via XML message (A2A mode)
Standing facilities use of the respective banking community query	X	X
Usage of marginal lending query	X	-
Usage of overnight deposit query	X	-

Table 54 - List of CB specific queries

As regards queries in A2A, details are provided in chapter [Send CLM query](#) [▶ 297], in the message specifications in following chapters and on MyStandards

As regards the queries in U2A, further details on search parameters and query results are provided in the CLM UHB, chapter "*Monitoring*".

8.7 Business/liquidity monitoring for CBs

Monitoring consists of providing data on the system according to an organised and human-readable form in order to allow the detection of potential problems in an early and accurate manner and to carry out the helpdesk activities.

In general, monitoring is understood as the display of aggregated information stemming from the different settlement services. It is not the main objective of monitoring to provide detailed information (e.g. detailed information about a single transaction). These are provided in the different settlement services directly.

The main objectives for monitoring are:

- l to verify the correct functioning of the technical infrastructure;
- l to provide aggregated information up-to-date in case of needs;
- l to give the CB an overview of the liquidity situation of its account holders.

The purpose of monitoring is to give the CB an overview of all the business running in TARGET Services. The detection of liquidity problems of the current business day for their account holders, i.e. the real-time monitoring of the overall liquidity situation is also part of monitoring.

The aim of monitoring is to have a closer look on the payment activities of the account holders (single account holder and aggregated levels) and monitoring of liquidity in order to avoid gridlocks.

Specific queries are available for CBs in order to monitor the business and the overall liquidity situation. A comprehensive list of CB-specific queries is provided in chapter [Query management - CB specific queries](#) [▶ 200].

Further details on the information available for monitoring are provided in the CLM UHB, chapter "*Monitoring*".

8.8 Minimum reserve management and interest calculation - specific functions for CBs

Chapter [Minimum reserve management and interest calculation](#) [▶ 139] provides a comprehensive overview of the features and functionalities available. In the following, the functionality available for CBs only is described in further detail.

8.8.1 Maintain minimum reserve requirement

CBs submit the calculated minimum reserve requirement for each of their institutions subject to the Eurosystem's minimum reserve requirements to CLM.

The value for the upcoming minimum reserve maintenance period can be entered in A2A as well as in U2A mode. In case of need, it is also possible for the CBs to update the reserve requirement of an institution during the current maintenance period. In such case, the new total amount needs to be defined by the responsible CB.

Further details on the A2A process are provided in chapter [Maintain minimum reserve requirement order](#) [▶ 285].

Details on the processing via U2A are provided in the CLM UHB, chapter "*Minimum Reserves*".

8.8.2 Insert or adjust balance for minimum reserve fulfilment

CBs can use this functionality to insert or adjust EoD balances to be considered for the fulfilment of the minimum reserve requirement of an institution. More precisely, it can be used by a CB:

- I on a regular basis, to insert additional EoD balances of accounts held by a party with the respective CB outside the TARGET Services. Those balances to be added for each current or previous business day in the current minimum reserve maintenance period are submitted to CLM as a credit adjustment, i.e. a positive delta amount, which increases the minimum reserve fulfilment balance for the respective date;
- I as a contingency measure, in order to adjust the aggregated EoD balance of a party calculated by the CLM on the basis of the CLM Account data, the general ledgers received from the other settlement services and manually inserted balances for that party (see bullet point above). The aggregated balance calculated and stored in CLM for each current or previous business day can be adjusted by sending a credit or a debit adjustment, i.e. a positive or a negative delta amount, which increases or decreases the minimum reserve fulfilment balance for the respective date.

Note: Technically there is no difference between the insert on regular basis mentioned in the first bullet point and a credit adjustment as a contingency measure mentioned in the second bullet point as in both cases a positive delta is submitted in the same way.

This functionality can be used for CLM Account Holders holding the minimum reserve:

- | directly;
- | in a pool of reserve accounts of different parties.

The functionality is available via A2A and U2A.

Note: The adjustments need to be submitted before the start of the minimum reserve calculations on the last business day of the minimum reserve maintenance period. After processing of an adjustment, CLM considers the submitted adjustments for the next and all upcoming minimum reserve calculations (i.e. for the calculation of the running average and the adjustment balance during the [End-of-day period \(18:00 - 18:45 CET\)](#) [▶ 87] till the end of the current minimum reserve maintenance period.

Further details on the A2A process are provided in chapter [Insert or adjust balance for minimum reserve fulfilment](#) [▶ 287].

This functionality might be used by a CB in case that a certain amount of liquidity is seized on the MCA of a CLM Account Holder and shall not be taken into account for its minimum reserve fulfilment. Further details are provided in chapter [Seizure of funds](#) [▶ 189] .

8.8.3 Administrative minimum reserve penalty

In case there is an infringement of the minimum reserve requirements and penalties are due to be paid by the affected institutions subject to the Eurosystem's minimum reserve system, a CB has to authorise or cancel such penalty before the payment order is created. Administration of minimum reserve penalties can be done in A2A and in U2A mode.

A payment order related to a penalty is only created in case the CB has taken a decision which penalty rate needs to be applied. In case a CB decides to cancel, no payment order is created.

Further details on the A2A process can be found in chapter [Administrative minimum reserve penalty order](#) [▶ 293].

8.9 Standing facilities - specific functions for CBs

Chapter [Standing facilities management](#) [▶ 144] provides a comprehensive overview of the features and functionalities available.

However, a CLM Account Holder cannot set up marginal lending on request directly in CLM. Only the CB responsible for the CLM Account Holder can set up marginal lending on request by sending a liquidity transfer order via its local CMS or manually via U2A. After ECMS go-live ECMS triggers marginal lending on request.

Until ECMS go-live, CBs can set up a marginal lending on request until 18:40 CET (with additional 15 minutes on the last day of the minimum reserve maintenance period).

Further details on the A2A processing are provided in chapter [Process marginal lending on request - setting up order](#) [▶ 278].

8.10 Specific requirements for out-CBs

In general, from a pure technical perspective, there is no difference in the functionality provided to Eurosystem CBs or CBs not part of the Eurosystem which are located in the EEA (so-called “out”-CBs). Differences which are agreed and defined on policy level are out of scope of this UDFS description. This means that technically also out-CBs have access to CB-specific features like e.g. provisioning of intraday credit to their CLM Account Holder and standing facilities. In addition, the cross-CB turnover is calculated for out-CBs and settled on the respective CB ECB account.

The only specific feature refers to the overnight deposit functionality. The process for the setting up and the refunding is the same as for eligible institutions of Eurosystem CBs, but the interest for CLM Account Holders of “out” countries is paid accumulated on a monthly basis. Further details can be found in chapter [Process overnight deposit - refund and interest](#) [▶ 276].

Furthermore, as regards the setting up of the overnight deposit, a control is in place in order to verify that the total amount envisaged for each “out” country is not exceeded. Each out-CB decides whether the access to the function is allowed only for the out-CB on behalf of the CLM Account Holder or directly granted to the CLM Account Holder.

8.11 Contingency settlement - ECONS II

ECONS II (Enhanced Contingency Solution II) is a contingency component which would be **activated if** CLM/RTGS are disturbed and not working. The contingency session can be opened for several business days (up to 5 business days).

The following chapter describes only the CLM relevant aspects of ECONS II processing.

After the contingency session is closed (ECONS II closing day), the balances remaining on the Contingency Accounts in ECONS II are transferred to CLM. ECONS II sends these balances via (a) modified “General ledger”/BankToCustomerStatement” message(s) (camt.053) (one for each currency). CBs have to adjust the balances for reserve management and standing facilities in case of need on the basis of the general ledger message sent by ECONS II after having changed each business day in ECONS II.

After the processing of the “General ledger”/BankToCustomerStatement (camt.053)” message in CLM is ECONS II closed:

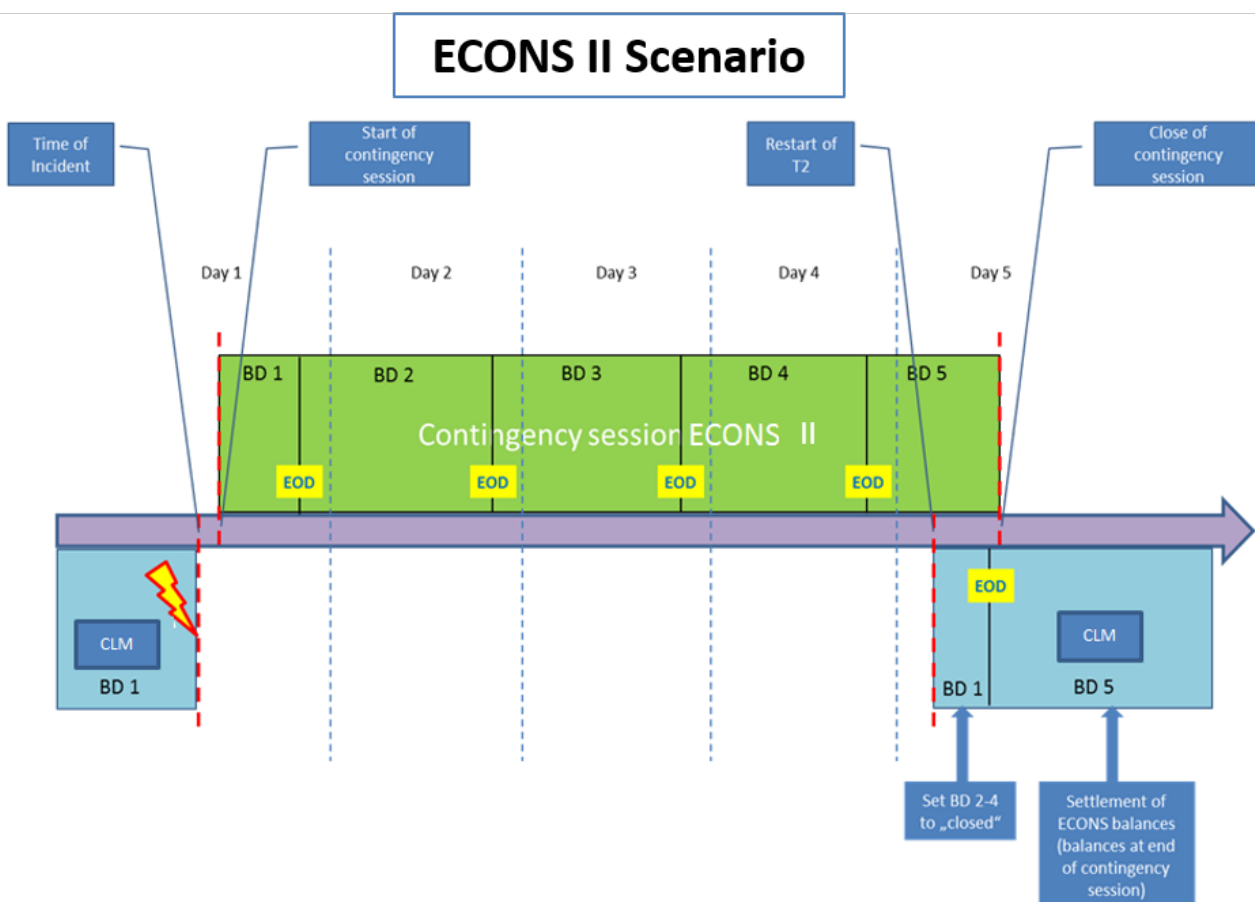

Figure 40 - Interaction between ECONS II and CLM during a disturbance in CLM/RTGS

In the specific case where CLM is available again after a prolonged outage (i.e. an outage lasting for more than one business day), CLM will initially resume operations with the incident business day (e.g. day BD 1).

As a prerequisite for CLM to catch up with the business day which ECONS II has already reached (e.g. BD 5), the transit account balances in CLM need to be aligned using agreed operational procedures. Only thereafter, the CLM incident business day (day BD 1) can be closed and CLM opened for the business day which ECONS II has already reached (BD 5). Once this alignment in business days has taken place, ECONS II can be closed and the related balances transferred to CLM.

8.12 Contingency upload of A2A files and messages in U2A

This procedure enables CBs to forward messages (except for queries) or files to CLM in case their participants' connection to the NSP is interrupted or the provider has problems to process messages/files.

In this case it is possible that the respective CB uploads files or messages either on behalf of the participant or for its own use. This is possible via a dedicated GUI screen by using an uncompressed UTF-8 txt file with maximum size 32 MB. The upload itself follows the four-eyes principle, which means that two users have to upload the file or message independently from each other. There is a check done by the system that the checksum of both files/messages are the same. In order to continue with the upload the DN of the sender

(original sender, i.e. not the user who executes the upload), Business signature DN and the NSP have to be inserted. CLM executes the same validations, which it would execute in case of standard A2A channel delivery.

The message or file to be uploaded does not need to be signed. If a signature is present, it will not be checked by CLM.

Both users need the privilege as described in the CRDM UDFS, chapter "*Privilege*" in the table "*CLM functions*" and in the CLM UHB, chapter "*List of Privileges*".

The communication between participant and CB is under the full responsibility of the CB and subject to an internal guideline.

Part II - Dialogues with the CLM Actor

9 Processes with CLM

The purpose of part II of this UDFS is to describe the interactions between CLM and the business application of a CLM Actor for a given business scenario (use case). It provides a formalised description of the A2A interfaces in order to enable CLM Actors to adapt their business applications to interact with the settlement service CLM. Part II of this UDFS does not enter into any description regarding the required behaviour of the business application(s) of CLM Actors, as this determination remains in the remit of the respective CLM Actor.

This chapter uses activity diagrams in accordance with UML conventions for presenting the processes and actions in CLM that result in message exchanges with the CLM Actor(s). This chapter describes the behaviour of CLM from the perspective of a technically directly connected CLM Actor. The descriptions in this chapter document only the CLM activities that process an inbound communication or trigger a possible outgoing communication to a CLM Actor. The chapter does not document internal processing steps when those processing steps that do not lead to the disclosure of information (sending of messages) to users.

Note: The same conventions apply for the status transition diagrams used in chapter [Status management process](#) [152].

Conventions used

The examples in the subsequent diagrams provide an overview of the conventions used:

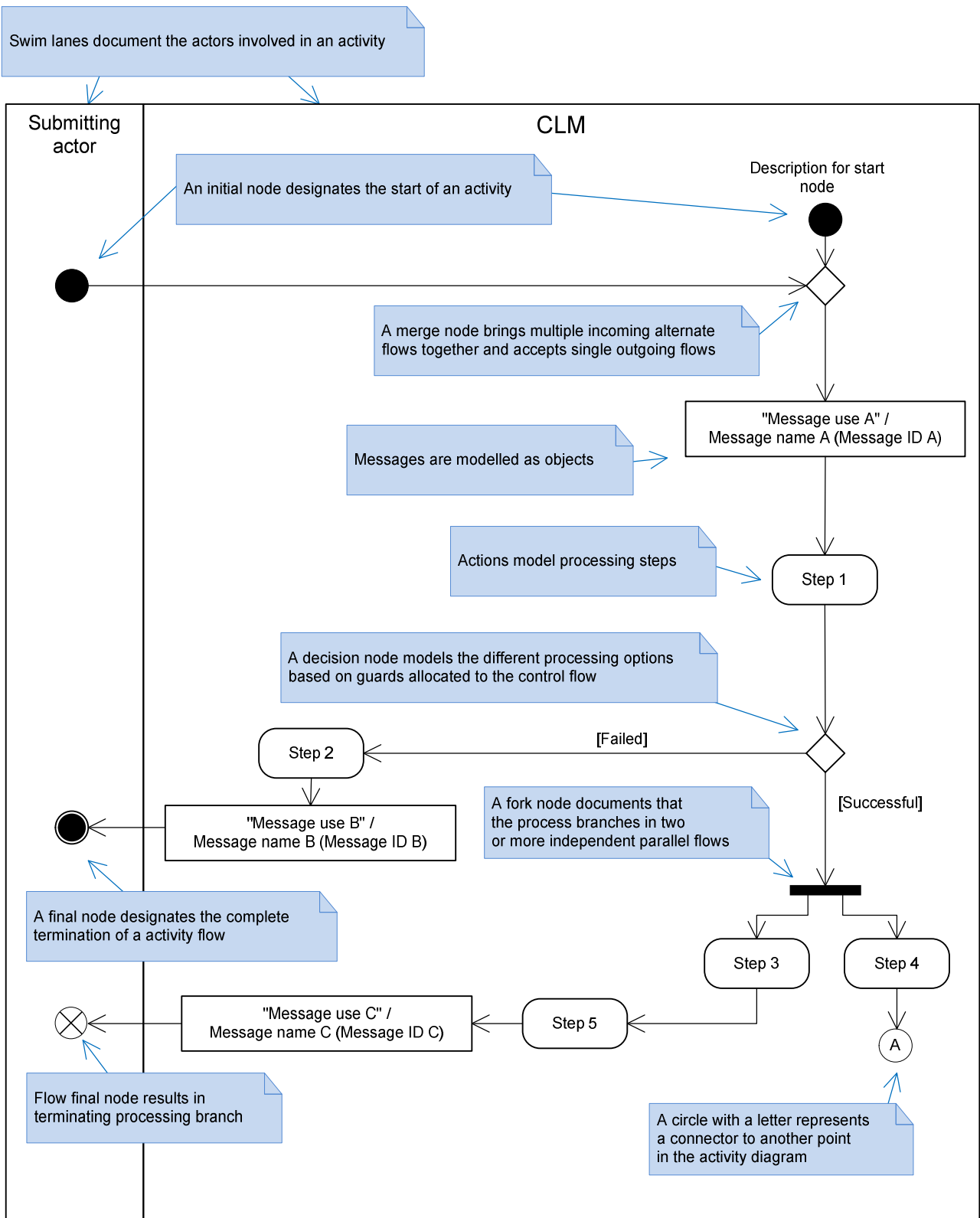

Figure 41 - UML conventions – example I

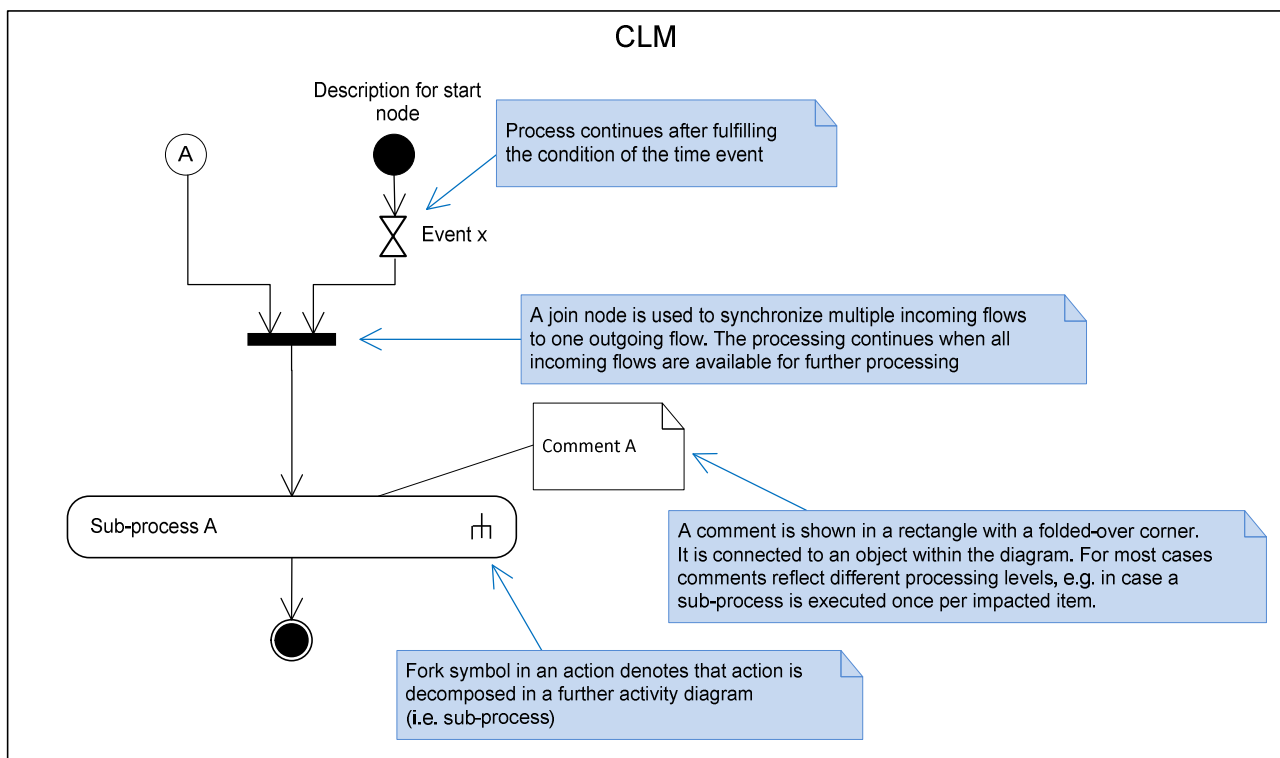

Figure 42 - UML conventions - example II

Each use case generally consists of one diagram. However, this approach can lead to very complex diagrams when a given use case covers many possible process variations. In order to reduce this complexity to ensure readability, a use case may be:

- I decomposed to provide diagrams on the level of its sub-processes;
- I provided as a universal diagram to cover several use cases of the same type (e.g. a generic send query use case instead of a use case for each query).

9.1 Send CLM file

9.1.1 Description

This activity diagram describes the processing that takes place in CLM when a submitting actor sends a file to CLM. A file is a communication that consists of a BFH and one or many individual message(s) for CLM to process. The file can contain different kind of instructions (e.g. payment orders, amendments of payment order, liquidity transfer orders etc.) but all contained instructions have to be directed to CLM only and must not be mixed with instructions to other components (e.g. CRDM or RTGS). Furthermore apart from instructions to CLM no other types of requests are allowed to be sent in a file (e.g. queries):

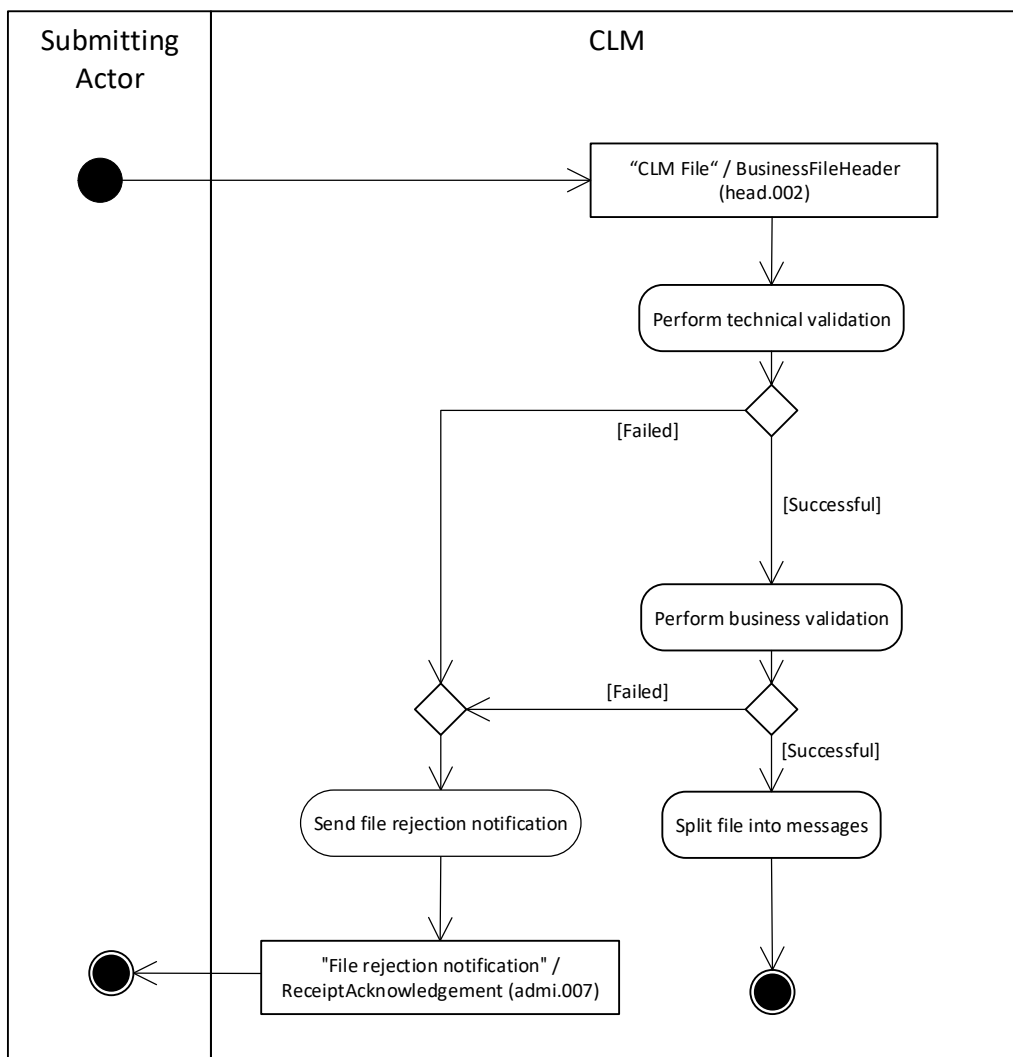

Figure 43 - Send CLM file

CLM receives a file as a communication that has a BFH ([BusinessFileHeader \(head.002\)](#) [▶ 555]) with one or many technical wrappers (head.003) that each contains an individual message. Chapter [Business File Header](#) [▶ 319] provides further details.

Perform technical validation

CLM performs the technical validation of BFH including technical wrapper(s). It validates the compliance of the file structure against the schema. The process identifies as many as possible technical validation errors.

- | **[Failed]** The submitted file is not compliant with the technical validation rules. The processing continues with the process step “Send file rejection notification”.
- | **[Successful]** The submitted file complies with the technical validation rules. The processing continues with the process step “Perform business validation”.

Perform business validation

CLM performs the business validation of the BFH. The process identifies as many as possible business validation errors.

- I **[Failed]** The file is not compliant with the business validation rules. The processing continues with the process step “Send file rejection notification”.
- I **[Successful]** The file complies with the business validation rules. The processing continues with the process step “Split file into messages”.

Send file rejection notification

This process step sends a “File rejection notification”/[ReceiptAcknowledgement \(admi.007\)](#) [▶ 370] that includes all identified errors that resulted in the failed validation to the submitting actor.

Split file into messages

This process step splits the file into individual messages and submits these single messages to the message processing.

9.1.2 Messages

Message description/usage	ISO message	ISO code
CLM File	BusinessFileHeader [▶ 555]	head.002 [▶ 555]

Table 55 - Inbound messages for Send CLM file

Message description/usage	ISO message	ISO code
File rejection notification	ReceiptAcknowledgement [▶ 370]	admi.007 [▶ 370]

Table 56 - Outbound messages for Send CLM file

9.2 Send CLM message

9.2.1 Description

This activity diagram describes the processing that takes place in CLM for a message when a submitting actor sends a single message to CLM or CLM processes a single message from a file.

Note: A message in the context of this process is a communication from a submitting actor to CLM to initiate specific business processing in CLM.

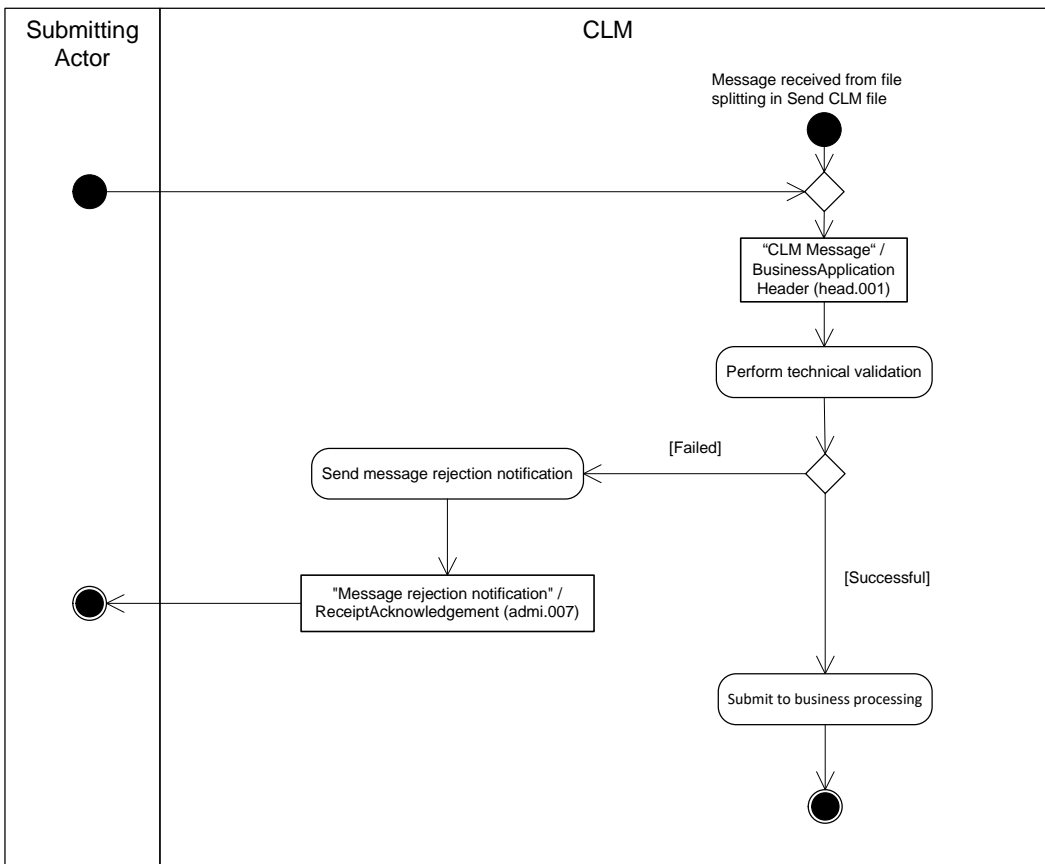

Figure 44 - Send CLM message

CLM receives an individual message from a submitting actor or from the [Send CLM file](#) [▶ 209] process and continues with the step “Perform technical validation”.

Perform technical validation

CLM triggers a technical validation of the message. The technical validation verifies the compliance of the message against the schema that CLM requires for the message. The process identifies as many as possible technical validation errors.

- l **[Failed]** The submitted message is not compliant with the technical validation rules. The processing continues with the process step “Send message rejection notification”.
- l **[Successful]** The submitted message complies with the technical validation rules. The processing continues with the process step “Submit to business processing”.

Send message rejection notification

This process step sends to the submitting actor a “Message rejection notification”/[ReceiptAcknowledgement \(admi.007\)](#) [▶ 370] that includes all identified errors that resulted in the failed.

Submit to business processing

The process step submits the message to the respective business processing in CLM.

9.2.2 Messages

Message description/usage	ISO message	ISO code
CLM Message	BusinessApplicationHeader [▶ 549]	head.001 [▶ 549]

Table 57 - Inbound messages for Send CLM message

Message description/usage	ISO message	ISO code
Message rejection notification	ReceiptAcknowledgement [▶ 370]	admi.007 [▶ 370]

Table 58 - Outbound messages for Send CLM message

9.3 Process CLM payment order and liquidity transfer order

9.3.1 Description

This activity diagram describes the processing of payment orders and liquidity transfer orders after the successful technical validation of the underlying message that contains the payment order or the liquidity transfer order.

Note: The following use cases are classified as liquidity transfer orders (sent by the submitting actor via A2A). In principle, their handling is identical to the one for all liquidity transfer orders in CLM and the respective notifications as described in this process:

- I [Process overnight deposit - setting up order](#) [▶ 275];
- I [Process overnight deposit - reverse order](#) [▶ 275];
- I [Process marginal lending on request - setting up order](#) [▶ 278].

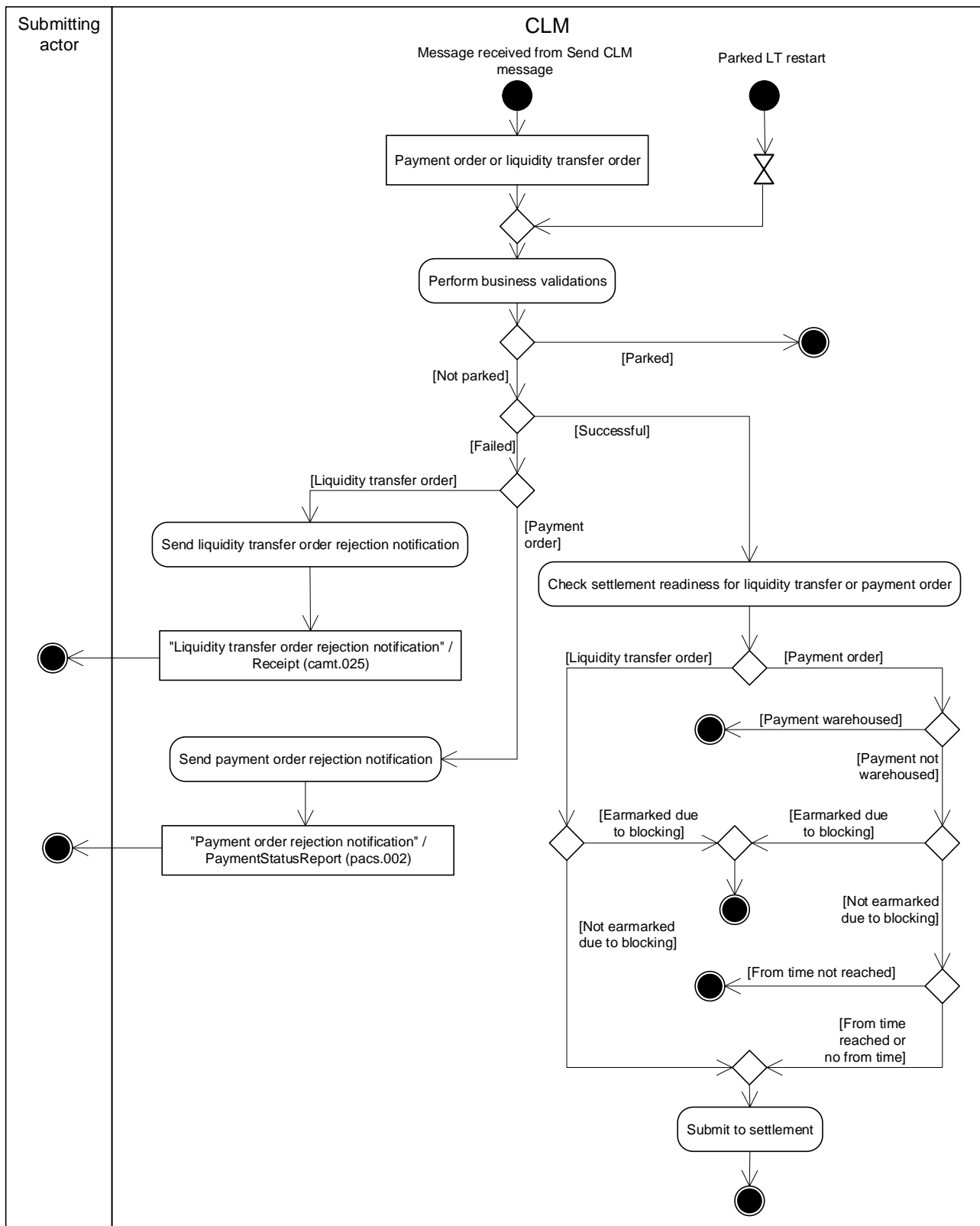

Figure 45 - Process CLM payment order and liquidity transfer order

This process receives an individual message from the [Send CLM message](#) [▶ 211] process or it starts processing after restart of parked liquidity transfer orders and continues with the step “Perform business validations”.

Perform business validations

The process verifies the compliance of a payment order or liquidity transfer order against the business validation rules. At the beginning of business validation CLM checks if the individual message is a liquidity transfer order and if the system status allows processing or requires parking. The process performs the business validations to the extent possible in order to report the maximum number of validation errors to the submitting actor.

- l **[Parked]** In case the liquidity transfer order is subject to parking, the processing terminates.
- l **[Not parked]** In case the individual message is not a liquidity transfer order or the liquidity transfer order is not subject to parking, the step continues with business validation.
- l **[Failed]** The payment order or liquidity transfer order is not compliant with the business validation rules. In case of a liquidity transfer order, the processing continues with the step “Send liquidity transfer order rejection notification”. In case of a payment order, the processing continues with the step “Send payment order rejection notification”.
- l **[Successful]** The payment order or liquidity transfer order complies with the business validation rules. The processing continues with the step “Check settlement readiness for liquidity transfer or payment order”.

Send liquidity transfer order rejection notification

The process step creates a “Liquidity transfer order rejection notification”/[Receipt \(camt.025\)](#) [▶ 479] and sends it to the submitting actor.

Send payment order rejection notification

The process step creates a “Payment order rejection notification”/[PaymentStatusReport \(pacs.002\)](#) [▶ 615] and sends it to the submitting actor.

Check settlement readiness for liquidity transfer or payment order

This processing step determines the state to which the payment order or liquidity transfer order must be set after the successful business validation. If the intended settlement date of the payment order is after the current business day, then the processing step sets the payment order to “warehoused”. If the blocking check described in chapters [Blocking/unblocking party](#) [▶ 47] and [Blocking/unblocking account](#) [▶ 60] results in blocking of the payment order or liquidity transfer order, the processing step sets it to “earmarked”. If the from time is not reached yet, then the processing step sets the payment order to “earmarked”.

Otherwise, the processing continues with “Submit to settlement”.

Submit to settlement

This processing step submits the payment order or the liquidity transfer order to the process [Perform standard CLM settlement](#) [▶ 223].

9.3.2 Messages

Message description/usage	ISO message	ISO code
Financial institution credit transfer order	FinancialInstitutionCreditTransfer [▶ 624]	pacs.009 [▶ 624]
Financial institution direct debit order	FinancialInstitutionDirectDebit [▶ 633]	pacs.010 [▶ 633]
Liquidity credit transfer order	LiquidityCreditTransfer [▶ 505]	camt.050 [▶ 505]

Table 59 - Inbound messages for process CLM payment order and liquidity transfer order

Message description/usage	ISO message	ISO code
Payment order rejection notification	PaymentStatusReport [▶ 615]	pacs.002 [▶ 615]
Liquidity transfer order rejection notification	Receipt [▶ 479]	camt.025 [▶ 479]

Table 60 - Outbound messages for process CLM payment order and liquidity transfer order

9.4 Perform CLM payment order revocation

9.4.1 Description

CLM provides functionality to revoke a queued payment order. CLM needs to receive a payment order revocation request to initiate the revocation of a queued payment order. CLM allows the revocation of the following types of payment order:

- I [FinancialInstitutionCreditTransfer \(pacs.009\)](#) [▶ 624];
- I [FinancialInstitutionDirectDebit \(pacs.010\)](#) [▶ 633].

Note: Only payment orders sent as regular payments can be revoked as connected payments are never queued. Details on the revocation functionality are provided in chapter [Revocation of payment orders](#) [▶ 106]. For information on the matching elements between the revocation message and the message of the payment order to be revoked, see [chapter Message References](#) [▶ 331].

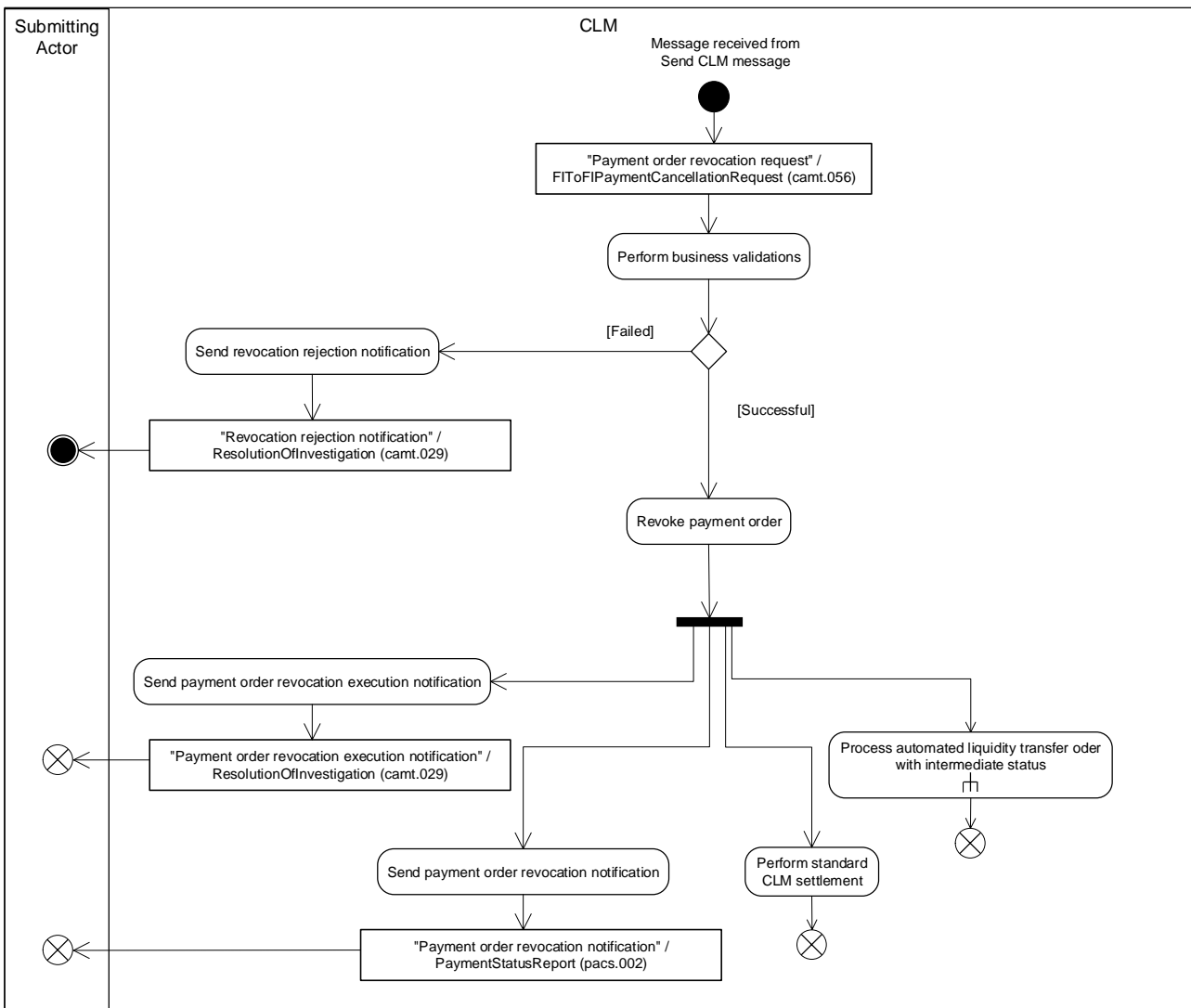

Figure 46 - Perform payment order revocation

This process receives an individual message from the [Send CLM message](#) [▶ 211] process and continues with the step “Perform business validations”.

Perform business validations

The process verifies the compliance of a payment order revocation request against the business validation rules. The process performs the business validations to the extent possible in order to report the maximum number of validation errors to the submitting actor.

- l **[Failed]** The payment order revocation request is not compliant with the business validation rules. The processing continues with step “Send revocation rejection notification”.
- l **[Successful]** The payment order revocation request complies with the business validation rules. The processing continues with “Revoke payment order”.

Send revocation rejection notification

The process step creates a “Revocation rejection notification”/[ResolutionOfInvestigation \(camt.029\)](#) [▶ 561] and sends it to the submitting actor.

Revoke payment order

The process step revokes the payment order and subsequently triggers in parallel the processing steps “Send payment order revocation execution notification”, “Send payment order revocation notification” and the sub-process [Process automated liquidity transfer order with intermediate status](#) [▶ 235] and resolve queue from [Perform standard CLM settlement](#) [▶ 223]. The standardized sub-process “Process automated liquidity transfer order with intermediate status” starts with a check if an automated liquidity transfer order exists, followed by a check on the needed liquidity for pending/queued CBOs before processing.

Send payment order revocation execution notification

The process step creates a “Payment order revocation execution notification”/[ResolutionOfInvestigation \(camt.029\)](#) [▶ 561] and sends it to the submitting actor.

Send payment order revocation notification

The process step creates a “Payment order revocation notification”/[PaymentStatusReport \(pacs.002\)](#) [▶ 615] and sends it to the submitting actor.

9.4.2 Messages

Message description/usage	ISO message	ISO code
Payment order revocation request	FIToFIPaymentCancellationRequest [▶ 573]	camt.056 [▶ 573]

Table 61 - Inbound message for perform CLM payment order revocation

Message description/usage	ISO message	ISO code
Payment order revocation execution notification	ResolutionOfInvestigation [▶ 561]	camt.029 [▶ 561]
Revocation rejection notification	ResolutionOfInvestigation [▶ 561]	camt.029 [▶ 561]
Payment order revocation notification	PaymentStatusReport [▶ 615]	pacs.002 [▶ 615]

Table 62 - Outbound messages for perform CLM payment order revocation

9.5 Execute CLM standing order

CLM standing order liquidity transfer orders are instructions of a CLM Account Holder to transfer regularly a fixed amount of money from its MCA.

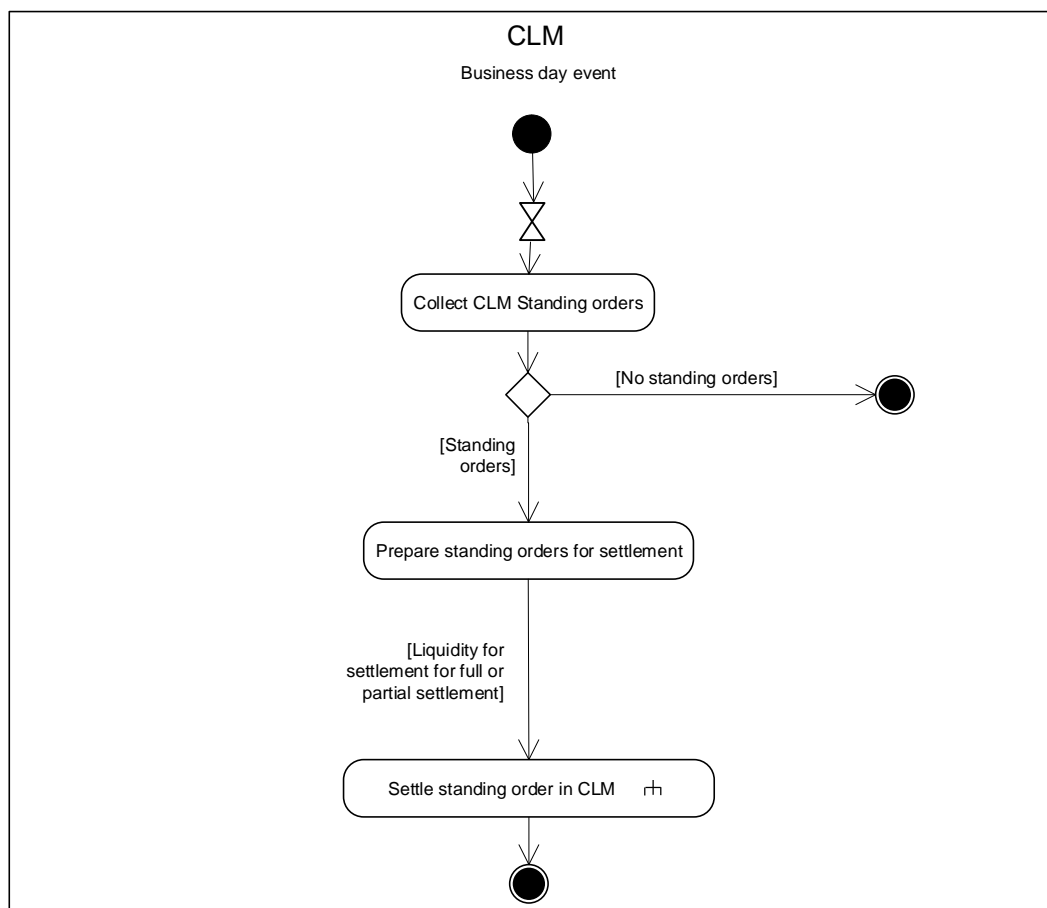

Figure 47 - Execute CLM standing order

The process is triggered by a business day event and continues with “Collect CLM standing orders”. Details of the business day and the relevant events are provided in chapter [Detailed description of the business day](#) [▶ 80].

Collect CLM standing orders

The receipt of a business event for the execution of standing order liquidity transfer orders results in the collection of all CLM standing order liquidity transfer orders for execution. The process continues when standing order liquidity transfer orders are found with the step “Prepare standing orders for settlement”. The process terminates when no standing order liquidity transfer order is found.

Prepare standing orders for settlement

The collection of standing order liquidity transfer orders results in their preparation for settlement. This process step submits all standing order liquidity transfer orders for settlement when sufficient liquidity is

available for full or partial settlement. When there is insufficient liquidity for full settlement, the process prepares the standing order liquidity transfer orders for pro rata settlement.

Note: In case there is no liquidity available for settlement, standing order liquidity transfer orders are settled with an amount of zero. Consequently, partial settlement also includes a settlement with an amount of zero.

The processing continues with the sub-process [Settle standing order in CLM](#) [▶ 220].

9.6 Settle standing order in CLM

9.6.1 Description

This sub-process is called for every settlement of a standing order liquidity transfer order and describes the outbound communications that take place as a result of the settlement:

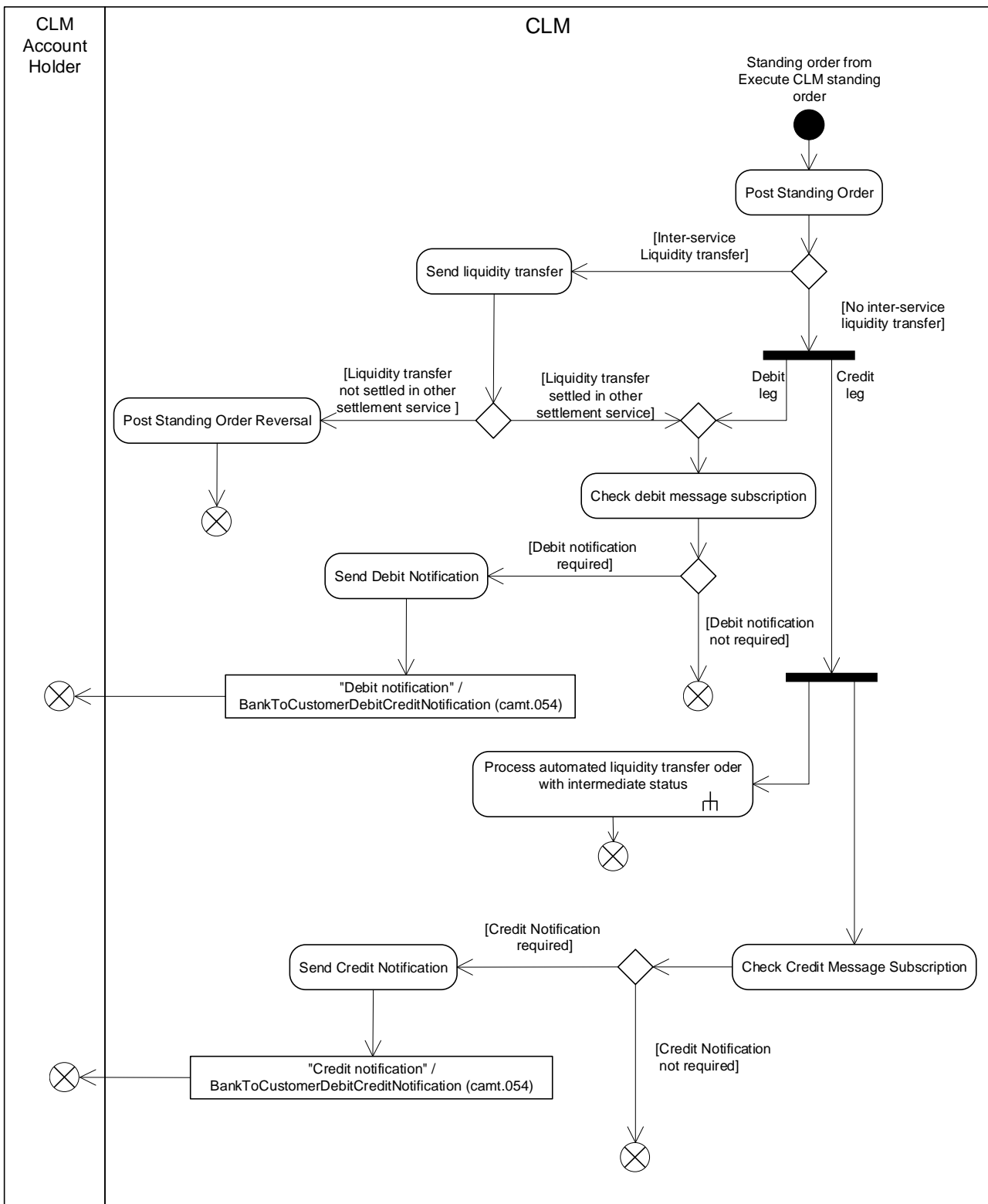

Figure 48 - Settle standing order in CLM

Post standing order

The posting of a standing order liquidity transfer order onto the respective accounts triggers the sending of notifications to the CLM Account Holders as well as additional process steps in case of an inter-service liquidity transfer order.

In case of an inter-service liquidity transfer order, the processing continues with the step “Send liquidity transfer”.

In case of an intra-service liquidity transfer, the processing continues with a parallel processing for the debit leg and the credit leg. For the debit leg the processing continues with the processing step “Check message subscription for debit notification”. For the credit leg it triggers in parallel to the processing step “Check message subscription for credit notification” the sub-process [Process automated liquidity transfer order with intermediate status](#) [▶ 235].

Send liquidity transfer

If the posting relates to an inter-service liquidity transfer order, then CLM sends a credit liquidity transfer to the respective settlement service.

Based on the settlement result received from the target settlement service, the processing continues as follows:

- I **[Settled]** – If the respective settlement service settles the inter-service liquidity transfer order, then the processing continues with the step “Check message subscription for debit notification”;
- I **[Not settled]** – If the respective settlement service does not settle the inter-service liquidity transfer order, then the processing continues with the step “Post standing order reversal”.

Post standing order reversal

CLM reverses the posting for the CLM standing order liquidity transfer.

Check message subscription for debit notification

CLM checks whether a message subscription exists for the CLM Account Holder to notify the settlement. In case a message subscription exists, the processing continues with the step “Send debit notification”.

Send debit notification

This process step sends the “Debit notification”/[BankToCustomerDebitCreditNotification \(camt.054\)](#) [▶ 520] to the CLM Account Holder.

Check message subscription for credit modification

CLM checks whether a message subscription exists for the CLM Account Holder to notify the settlement. In case a message subscription exists, the processing continues with the step “Send credit notification”.

Send credit notification

This process step sends the “Credit notification”/ [BankToCustomerDebitCreditNotification \(camt.054\)](#) [▶ 520] to the CLM Account Holder.

9.6.2 Messages

Message description/usage	ISO message	ISO code
Debit notification	BankToCustomerDebitCreditNotificatio n [520]	camt.054 [▶ 520]
Credit notification	BankToCustomerDebitCreditNotificatio n [520]	camt.054 [▶ 520]

Table 63 - Outbound messages for settle standing order in CLM

9.7 Perform standard CLM settlement

9.7.1 Description

The standard CLM settlement process attempts to settle the following cash transfer order types in CLM:

- | all types of payment orders except connected payment orders;
- | all types of liquidity transfer orders except standing order liquidity transfer orders.

Chapter [Settle connected payments](#) [▶ 243] specifies the settlement process for connected payments owing to the different processing logic.

Standing order liquidity transfers are settled as well in a dedicated settlement process, which is described in chapter [Settle standing order in CLM](#) [▶ 220].

Note:

The following use cases are classified as liquidity transfer orders. In principle, their handling is identical to the one for all liquidity transfer orders in CLM and the respective notifications as described in this process:

- | [Overnight deposit – setting up](#) [▶ 275];
- | [Overnight deposit – reverse](#) [▶ 275];
- | [Overnight deposit – refund](#) [▶ 276];
- | [Marginal lending on request – setting up](#) [▶ 278];⁶⁹
- | [Marginal lending on request – reimbursement](#) [▶ 282].⁷⁰

69 Until ECMS go-live. After ECMS go-live the processes will be performed by a connected payment or a regular payment submitted by ECMS.

The following use cases are classified as payment orders. In principle, their handling is identical to the one for all payment orders in CLM and the respective notifications as described in this process:

- | [Interest payment related to overnight deposit](#) [▶ 276];
- | [Interest payment related to marginal lending](#) [▶ 282]⁷¹ ;
- | [Interest payment related to minimum reserve](#) [▶ 290];
- | [Interest payment related to excess reserve](#) [▶ 290];
- | [Interest payment related to an account subject to interest calculation](#) [▶ 260];
- | [Penalty payment related to minimum reserve](#) [▶ 285].

70 Until ECMS go-live. After ECMS go-live the processes will be performed by a connected payment or a regular payment submitted by ECMS.

71 Until ECMS go-live. After ECMS go-live the processes will be performed by a connected payment or a regular payment submitted by ECMS.

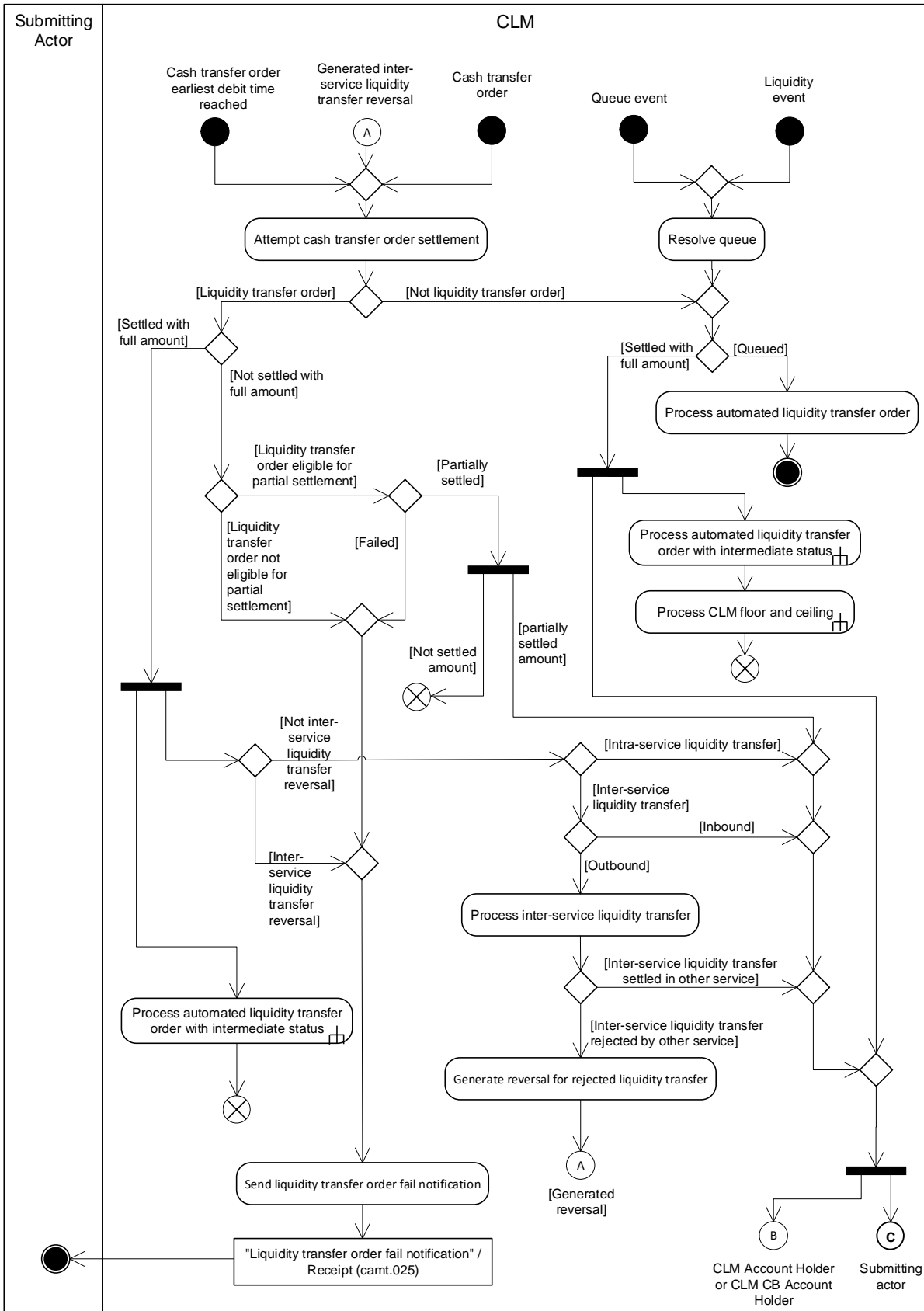

Figure 49 - Standard CLM settlement I

Either the process step “Attempt cash transfer order settlement” or the process step “Resolve queue” are at the beginning of the standard CLM settlement process.

One of the following events triggers the process step “Attempt cash transfer order settlement”:

- | a cash transfer order for which the specified earliest debit time has been reached;
- | a reversal resulting from a settlement fail of an inter-service liquidity transfer that CLM had sent;
- | the receipt of a new cash transfer order from one of the following processes:
 - [Process CLM payment order and liquidity transfer order](#) [▶ 213];
 - [Process CLM floor and ceiling](#) [▶ 237];
 - [Process interest for accounts subject to interest calculation](#) [▶ 260];
 - [Process cross-CB turnover](#) [▶ 266];
 - [Process overnight deposit - refund and interest](#) [▶ 276];
 - [Process marginal lending - reimbursement and interest](#) [▶ 282];
 - [Process minimum reserve](#) [▶ 290];
 - [Administrate minimum reserve penalty order](#) [▶ 293].

One of the following events triggers the process step “Resolve queue”:

- | queue event, i.e. interventions at queue level also taking into account the agreement of a CB in case of blocking - possible via U2A only;
- | liquidity event, i.e. increase of liquidity on the MCA or CLM CB accounts.

Attempt cash transfer order settlement

The processing of a settlement attempt of a cash transfer order (excluding connected payments) depends on the underlying cash transfer type:

Cash transfer order type	Initiation	possible results			
		Queued	Settled with full amount	Failed	Partially settled - no further settlement attempt
Payment orders (excluding connected payments)	Not relevant	X	X		
Liquidity transfer orders	CLM Account Holder		X	X	
	CB		X	X	

Cash transfer order type	Initiation	possible results			
		Queued	Settled with full amount	Failed	Partially settled - no further settlement attempt
	Pull sent from RTGS - rule-based liquidity transfer (floor breach or queued urgent/high priority payment)		X	X	X
	Push sent to RTGS - rule-based liquidity transfer (ceiling breach)		X		
	Pull sent from CLM - rule-based liquidity transfer (floor breach)		X	X	X
	Push sent to CLM - rule-based liquidity transfer (ceiling breach)		X		
	Push from any other settlement service (inbound liquidity transfer)		X		
	Inter-service liquidity transfer reversal (due to rejection of CLM outbound liquidity transfer by other settlement service)		X		

Table 64 - Possible results of “Attempt cash transfer order settlement”

Based on the possible results in process “Attempt cash transfer order settlement” the following next process step starts.

- I **[Settled with full amount]** – CLM settles the cash transfer order. The processing continues with the following process steps:
 - for settled outbound inter-service liquidity transfers with “Process inter-service liquidity transfer”;
 - for other settled liquidity transfers with the following parallel steps:
 - “B” for the CLM Account Holder or CLM CB Account Holder;
 - “C” for the submitting actor;
 In parallel to the mentioned process steps, the processing continues with sub-process [Process automated liquidity transfer order with intermediate status](#) [▶ 235].
 - for all other settled cash transfers with the following three parallel steps:
 - “B” for the CLM Account Holder or CLM CB Account Holder;
 - “C” for the submitting actor;
 - sub-process [Process automated liquidity transfer order with intermediate status](#) [▶ 235] and afterwards sub-process [Process CLM floor and ceiling](#) [▶ 237].
- I **[Queued]** – CLM queues the processed payment order. The processing continues with the step “Process automated liquidity transfer order”.
- I **[Not settled with full amount]** – CLM checks whether the liquidity transfer order is eligible for partial settlement or not. If it is eligible for partial settlement, the processing continues with the step “Partially settled – no further settlement attempt”.
- I **[Not partially settled]** – In case a liquidity transfer order cannot be settled with the full amount and it is not eligible for partial settlement, the settlement attempt fails. The processing continues with the step “Send liquidity transfer order fail notification”.
- I **[Partially settled - no further settlement attempt]** – The rule-based pull liquidity transfer order that RTGS or CLM initiates settles partially with no further settlement attempt. The processing continues with the three parallel steps:
 - “B” for the CLM Account Holder or CLM CB Account Holder;
 - “C” for the submitting actor;
 - sub-process [Process automated liquidity transfer order with intermediate status](#) [▶ 235].

Resolve queue

The process step tries to settle cash transfer orders employing the mechanism described in [Dissolution of the payment queue](#) [▶ 116]. The further processing depends on the possible processing result:

Cash transfer order type	possible results	
	queued	settled with full amount
Payment order	X	X

Table 65 - Possible results of “Resolve queue”

The outcome of the process “Resolve queue” triggers the next process step.

- I **[Settled with full amount]** – CLM settles the cash transfer order. The processing continues with the following three parallel steps:
 - “B” for the CLM Account Holder or CLM CB Account Holder;
 - “C” for the submitting actor;
 - sub-process [Process automated liquidity transfer order with intermediate status](#) [▶ 235] and afterwards sub process [Process CLM floor and ceiling](#) [▶ 237].
- I **[Queued]** – CLM queues the cash transfer order. The processing continues with “Process automated liquidity transfer order”.

Process automated liquidity transfer order

After the first settlement attempt of a payment order, the automated liquidity transfer processing may create an automated liquidity transfer order. Further details can be found in chapter [Automated liquidity transfer due to queued/pending CBO](#) [▶ 129].

Process inter-service liquidity transfer

The settlement of an inter-service liquidity transfer order results in the creation and sending of an inter-service liquidity transfer order to the target settlement service. Based on the settlement result received from the target settlement service, the processing continues as follows:

- I **[Settled]** – The processing continues with “B” for the CLM Account Holder or CLM CB Account Holder and “C” for the submitting actor;
- I **[Rejected]** – The processing continues with the step “Generate reversal for rejected liquidity transfer”.

Send liquidity transfer order fail notification

The process step creates a “Liquidity transfer order fail notification”/[Receipt \(camt.025\)](#) [▶ 479] and sends it to the submitting actor.

Generate reversal for rejected liquidity transfer

The process step creates an inter-service liquidity transfer reversal and submits it to “Attempt cash transfer order settlement”.

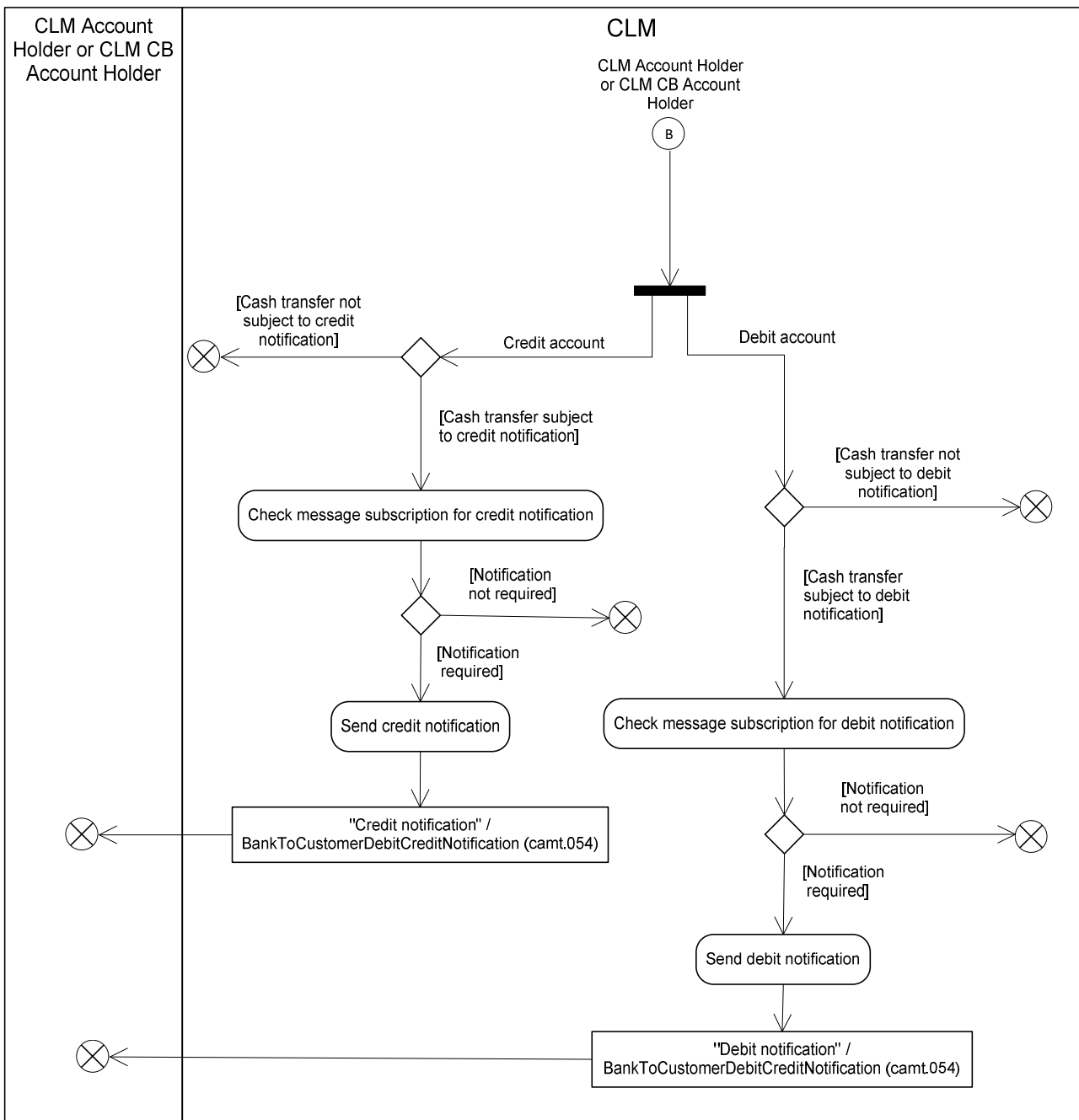

Figure 50 - Standard CLM settlement II

The following table documents whether the CLM Account Holder or CLM CB Account Holder receives a notification in terms of "Debit notification" and "Credit notification" from the standard CLM settlement process:

Cash transfer order type	Submission Type	Use Case	"Debit notification"/ Bank To Customer Debit Credit Notification (camt.054) [▶ 520]	"Credit notification"/ Bank To Customer Debit Credit Notification (camt.054) [▶ 520]
Payment	A2A	FinancialInstitutionCreditTransfer (pacs.009)	-	Optional
		FinancialInstitutionDirectDebit (pacs.010) [▶ 633]	Optional	-
	U2A	Any payment initiated via U2A	-	Optional
	System-generated	Any system-generated payment	Optional ⁷²	Optional ⁷³
Liquidity transfer	U2A	Liquidity transfer with credit on MCA, CLM CB Account, overnight deposit account or marginal lending account ⁷⁴ (credit leg)	-	Optional
		Liquidity transfer with debit on MCA, CLM CB Account, overnight deposit account or marginal lending account (debit leg)	Optional	-
	A2A	Liquidity transfer with credit on MCA, CLM CB Account or overnight deposit account (credit leg)	-	Optional
		Liquidity transfer with debit ⁷⁵ on MCA, CLM CB Account or marginal lending account	-	-

72 A CB can opt for a debit notification resulting from a settled [pacs.009](#) [▶ 622] payment sent by ECMS.

73 A CB can opt for a credit notification resulting from a settled [pacs.010](#) [▶ 631] payment sent by BILL.

74 A credit on the marginal lending account can be initiated via U2A only by the operator on behalf of the CB (reverse of a settled marginal lending on request).

75 In case the CB has sent the liquidity transfer on behalf of the CLM Account Holder, the CLM Account Holder can receive an optional [camt.054](#) [▶ 518] (subject to message subscription).

Cash transfer order type	Submission Type	Use Case	"Debit notification"/Bank ToCustomerDebit CreditNotification (camt.054) [▶ 520]	"Credit notification"/BankToCustomerDebitCreditNotification (camt.054) [▶ 520]
		(debit leg)		
		Liquidity transfer with debit on overnight deposit account (debit leg)	Optional	
	Internal (from other settlement service)	Liquidity transfer with debit on MCA or CLM CB Account. (debit leg)	Optional	-
		Liquidity transfer with credit on MCA, CLM CB Account, overnight deposit account. (credit leg)	-	Optional
	System-generated	Liquidity transfer with debit on MCA, CLM CB Account, overnight deposit account (debit leg)	Optional	-
		Liquidity transfer with credit on MCA, CLM CB Account or marginal lending account (credit leg)	-	Optional

Table 66 - Outbound CLM settlement notifications for the CLM Account Holder or CLM CB Account Holder

For the debit account the processing continues with the process step "Check message subscription for debit notification".

For the credit account the processing continues with the process step "Check message subscription for credit notification".

Check message subscription for debit notification

In case a message subscription exists for the debit notification for the CLM Account Holder or CLM CB Account Holder, the processing continues with the step "Send debit notification". Otherwise, CLM sends no debit notification.

Send debit notification

The process step creates a “Debit notification”/[BankToCustomerDebitCreditNotification \(camt.054\)](#) [▶ 520] for the liquidity transfer and sends it to the CLM Account Holder or CLM CB Account Holder.

Check message subscription for credit notification

In case a message subscription exists for the credit notification for the CLM Account Holder or CLM CB Account Holder, the processing continues with the step “Send credit notification”. Otherwise, CLM sends no credit notification.

Send credit notification

The process step creates a “Credit notification”/[BankToCustomerDebitCreditNotification \(camt.054\)](#) [▶ 520] for the liquidity transfer and sends it to the CLM or CLM CB Account Holder.

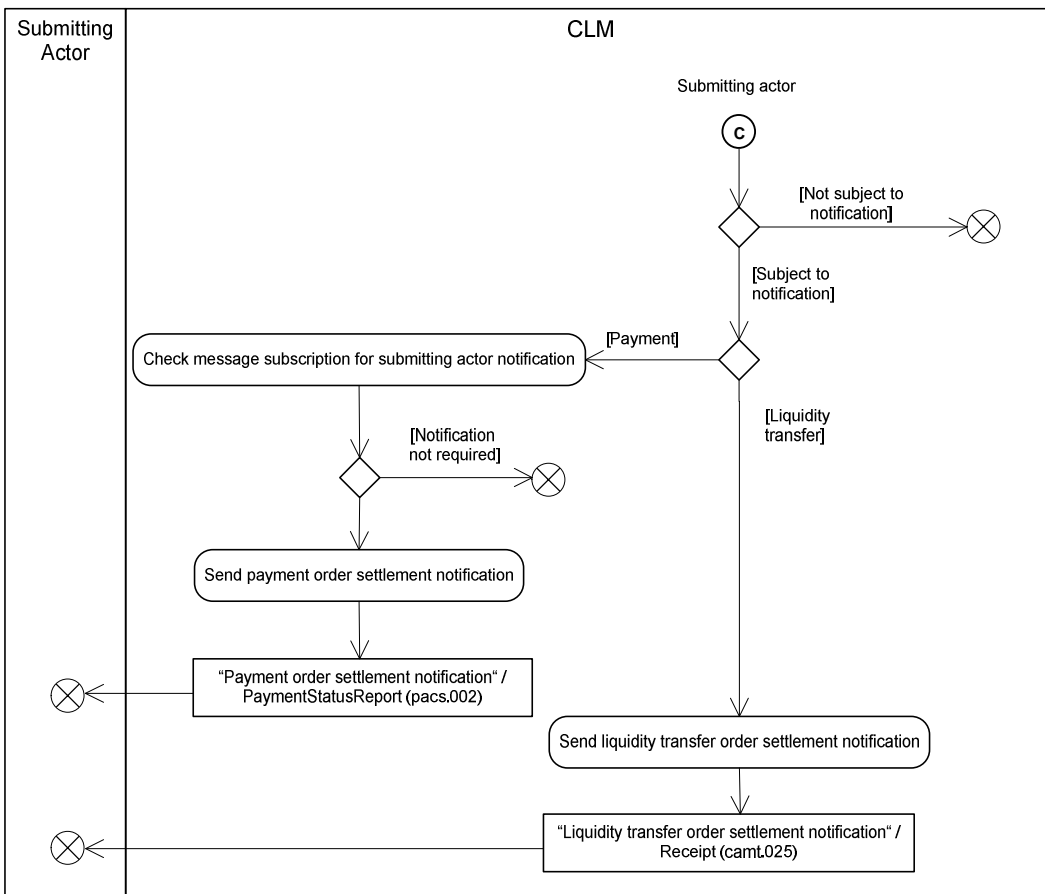

Figure 51 - Standard CLM settlement III

The following table documents whether the submitting actor receives a notification in terms of “Payment order settlement notification” or “Liquidity transfer order settlement notification” from the standard CLM settlement process:

Cash transfer order type	Submission Type	Use Case	“Payment order settlement notification”/“PaymentStatusReport (pacs.002) [▶ 615]”	“Liquidity transfer order settlement notification”/“Receipt (camt.025) [▶ 479]”
Payment	A2A	Any payment initiated via FinancialInstitutionCreditTransfer [▶ 624] (pacs.009) [▶ 624] or FinancialInstitutionDirectDebit (pacs.010) [▶ 633]	Optional	-
	U2A	Any payment initiated via U2A	-	-
	System-generated	Any system-generated payment	-	-
Liquidity transfer	U2A	Any liquidity transfer initiated via U2A	-	-
	A2A	Any liquidity transfer initiated via LiquidityCreditTransfer (camt.050) [▶ 505]	-	Mandatory
	Internal (from other settlement service)	Any internal liquidity transfer from another settlement service	-	-
	System-generated	Any system-generated liquidity transfer	-	-

Table 67 - Outbound CLM settlement notifications for the submitting actor

In case of a payment, the processing continues with the process step “Check message subscription for submitting actor notification”.

In case of a liquidity transfer, the processing continues with the process step “Send liquidity transfer order settlement notification”.

Check message subscription for submitting actor notification

In case a message subscription exists for the notification, the processing continues with the step “Send payment order settlement notification”. Otherwise, CLM sends no notification.

Send payment order settlement notification

The process step creates a “Payment order settlement notification”/[PaymentStatusReport \(pacs.002\)](#) [▶ 615] and sends it to the submitting actor.

Send liquidity transfer order settlement notification

The process step creates a “Liquidity transfer order settlement notification”/[Receipt \(camt.025\)](#) [▶ 479] and sends it to the submitting actor.

9.7.2 Messages

Message use	ISO message	ISO code
Liquidity transfer order fail notification	Receipt [▶ 479]	camt.025 [▶ 479]
Payment order settlement notification	PaymentStatusReport [▶ 615]	pacs.002 [▶ 615]
Liquidity transfer order settlement notification	Receipt [▶ 479]	camt.025 [▶ 479]
Debit notification	BankToCustomerDebitCreditNotification [▶ 520]	camt.054 [▶ 520]
Credit notification	BankToCustomerDebitCreditNotification [▶ 520]	camt.054 [▶ 520]

Table 68 - Outbound messages for process standard CLM settlement

9.8 Process automated liquidity transfer order with intermediate status

This standardised sub-process is triggered by one of the following processes with potential impact on the available liquidity of the CLM Account Holder:

- | [Perform CLM payment order revocation](#) [▶ 216];
- | [Settle standing order in CLM](#) [▶ 220];
- | [Perform standard CLM settlement](#) [▶ 223];
- | [Process CLM reject time](#) [▶ 239];
- | [Settle connected payments](#) [▶ 243];
- | [Modify credit line](#) [▶ 247];
- | [Manage current reservation in CLM](#) [▶ 253].

The processing continues with “Check on automated liquidity transfer order with intermediate status”:

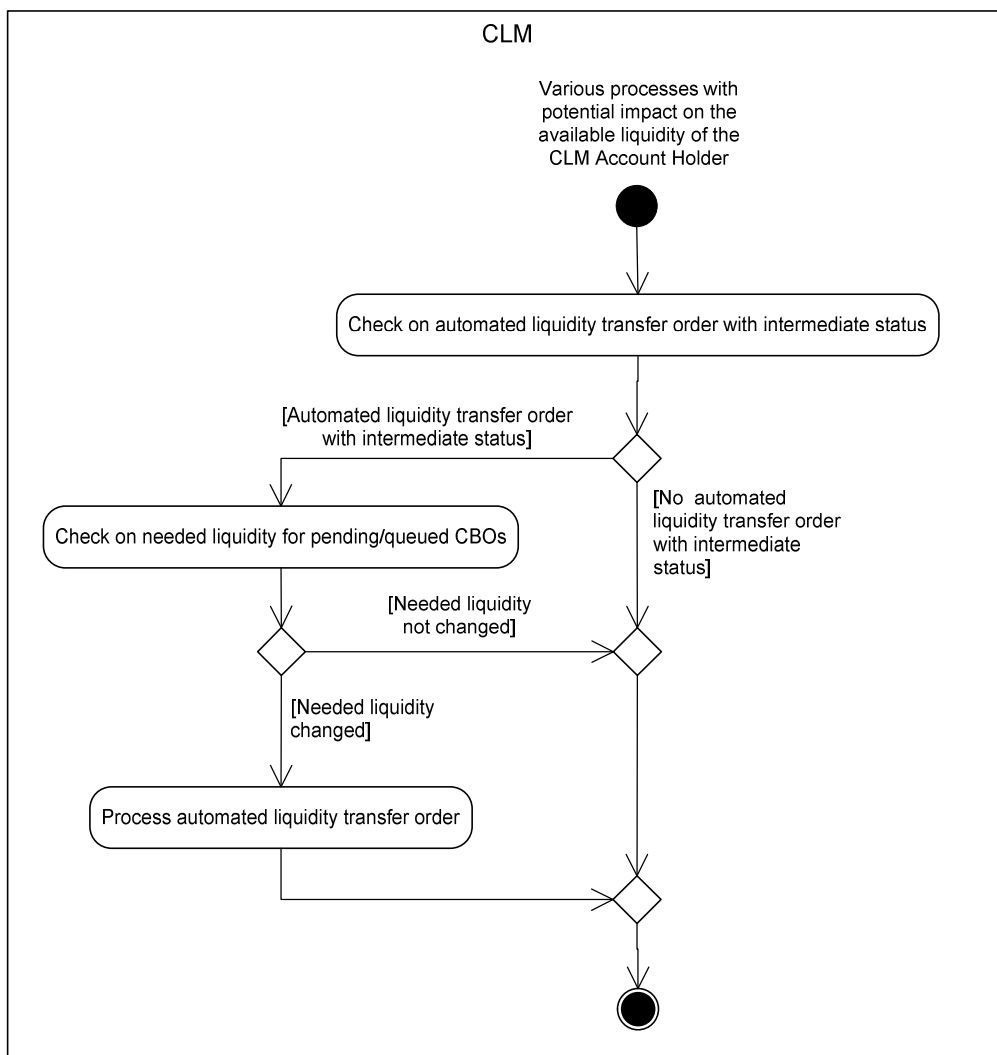

Figure 52 - Process automated liquidity transfer order with intermediate status

Check on automated liquidity transfer order with intermediate status

The processing step checks the existence of an automated liquidity transfer order with intermediate status. In case an automated liquidity transfer order exists as open business case in CLM, the processing continues with “Check on needed liquidity for pending/queued CBOs”. In case no automated liquidity transfer order as open business case exists in CLM, the processing ends.

Check on needed liquidity for pending/queued CBOs

The processing step checks if the needed liquidity for the processing of pending/queued CBOs of the CLM Account Holder has changed. In case the needed liquidity has changed, i.e. the sum of pending/queued CBOs of the CLM Account Holder minus its available liquidity is different to the amount of the automated liquidity transfer order with intermediate status, the processing continues with “Process automated liquidity transfer order”. In case the needed liquidity has not changed, the processing ends.

Process automated liquidity transfer order

In order to address the changed liquidity needs this processing step creates a new automated liquidity transfer order which replaces the previous one in RTGS. Further details can be found in chapter [Automated liquidity transfer due to queued/pending CBO](#) [▶ 129]. Afterwards the processing ends.

9.9 Process CLM floor and ceiling

9.9.1 Description

This standardised sub-process is triggered by one of the following processes:

- | [Perform standard CLM settlement](#) [▶ 223];
- | [Settle connected payments](#) [▶ 243];
- | [Modify credit line](#) [▶ 247]

and checks whether a posting on an MCA resulting from the settlement of a payment order or an execution of a credit line change breaches a defined floor amount or a defined ceiling amount on the MCA.

Note: The settlement of liquidity transfers does not result in the check of a floor breach or a ceiling breach.

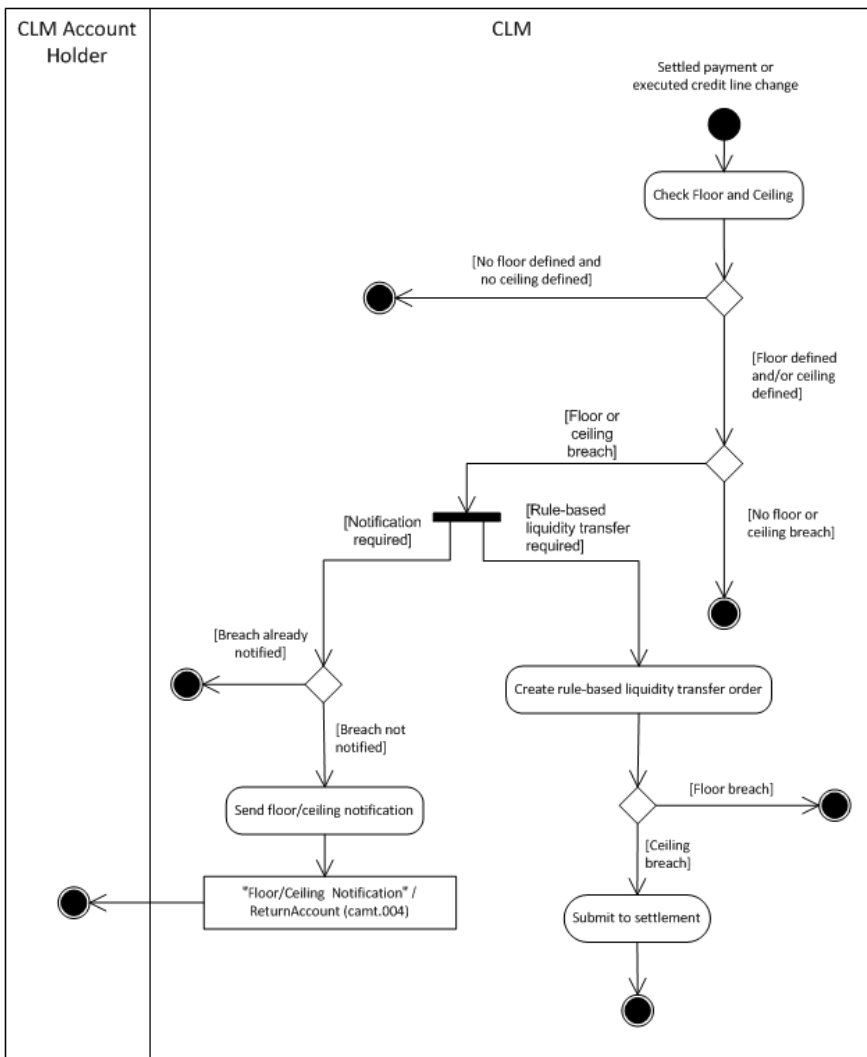

Figure 53 - Floor and ceiling processing

Check floor and ceiling

This process step first checks whether the CLM Account Holder has configured a floor amount or a ceiling amount for the MCA. The process terminates when neither a floor amount nor a ceiling amount is configured for the MCA. The process also terminates when a floor amount or a ceiling amount is configured for the MCA, but the check does not identify a breach. When the check identifies either a floor breach or a ceiling breach, then the check determines whether the breach requires a rule-based liquidity transfer order or a notification or both. In case the breach requires the notification of the breach, the process determines whether the breach was already notified. If it is the case, then the process terminates. Otherwise, it triggers the step “Send floor/ceiling notification”.

In case the breach requires a rule-based liquidity transfer, the processing continues with the step “Create rule-based liquidity transfer order” or executes this step in parallel to the notification, if applicable.

Send floor/ceiling notification

Depending on the breach, this processing step sends the “Floor/Ceiling notification”/[ReturnAccount \(camt.004\)](#) [▶ 380] (i.e. either floor notification or ceiling notification) to the CLM Account Holder.

Further details can be found in chapter [Breach of floor/ceiling threshold - notification](#) [▶ 136].

Create rule-based liquidity transfer order

This process step generates a liquidity transfer order based on a floor breach or a ceiling breach:

- I in case of a floor breach, a pull liquidity transfer is initiated to pull liquidity:
 - either from RTGS to CLM
 - or from a predefined MCA to another MCA within the same Liquidity Transfer Group subject to the floor
 - or from a CLM CB Account to another CLM CB Account or to an MCA belonging to a CB
 - or from an MCA belonging to a CB to a CLM CB Account;
- I in case of a ceiling breach, the processing continues with “Submit to settlement”.

Submit to settlement

This processing step submits the cash transfer order to the process [Perform standard CLM settlement](#) [▶ 223].

Further details can be found in chapter [Breach of floor/ceiling threshold – rule-based liquidity transfer](#) [▶ 136].

9.9.2 Messages

Message description/usage	ISO message	ISO code
Floor/ceiling notification	ReturnAccount [▶ 380]	camt.004 [▶ 380]

Table 69 - Outbound message for process CLM floor or ceiling notification

9.10 Process CLM reject time

A payment order may include a “latest debit time” indicator that specifies the time up to which CLM has to settle the payment order, i.e. the reject time. CLM monitors the reject time of payment orders. When CLM identifies that a payment order is still queued at its reject time, then CLM rejects the payment order.

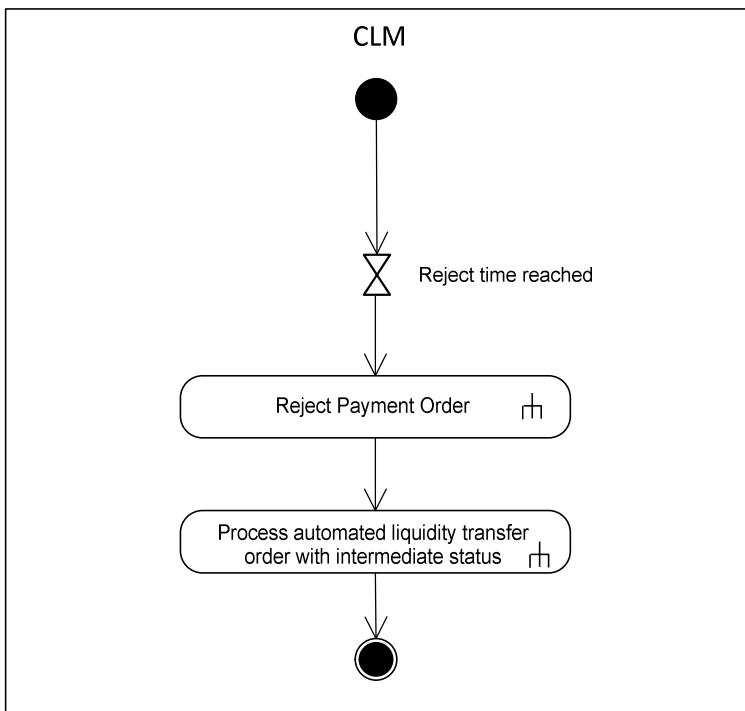

Figure 54 - Process CLM reject time

This process initiates the rejection of all payment orders due to reject time reached. The processing continues with the sub-process [Reject payment order](#) [▶ 259] and afterwards with the sub-process [Process automated liquidity transfer order with intermediate status](#) [▶ 235].

9.11 Initiate CLM reject time broadcast

A payment order may include a “latest debit time”. In case such “latest debit time” is defined, CLM monitors the latest debit time indicator of a payment order to initiate an A2A broadcast.

Further details on “latest debit time indicator” are provided in chapter [Definition of execution time](#) [▶ 98].

Further details on broadcasts can be found in chapter [Broadcasts](#) [▶ 168].

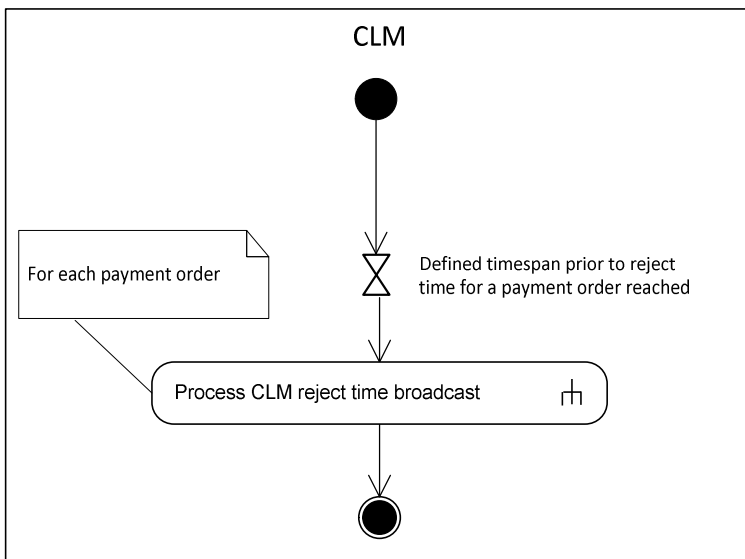

Figure 55 - Initiate CLM reject time broadcast

This process initiates the sending of an A2A broadcast.

The process is triggered in case a defined timespan prior to the indicated reject time for a payment order is reached. The processing continues with the sub-process [Process CLM reject time broadcast](#) [▶ 241].

9.12 Process CLM reject time broadcast

9.12.1 Description

This sub-process sends an A2A broadcast via [SystemEventNotification \(admi.004\)](#) [▶ 365] to the broadcast subscribing party, i.e. the CLM Account Holder or CLM CB Account Holder to be debited.

Note: The A2A broadcast is sent in addition to the U2A broadcast if the respective party has subscribed to receiving A2A broadcasts.

Further details on broadcasts can be found in chapter [Broadcasts](#) [▶ 168].

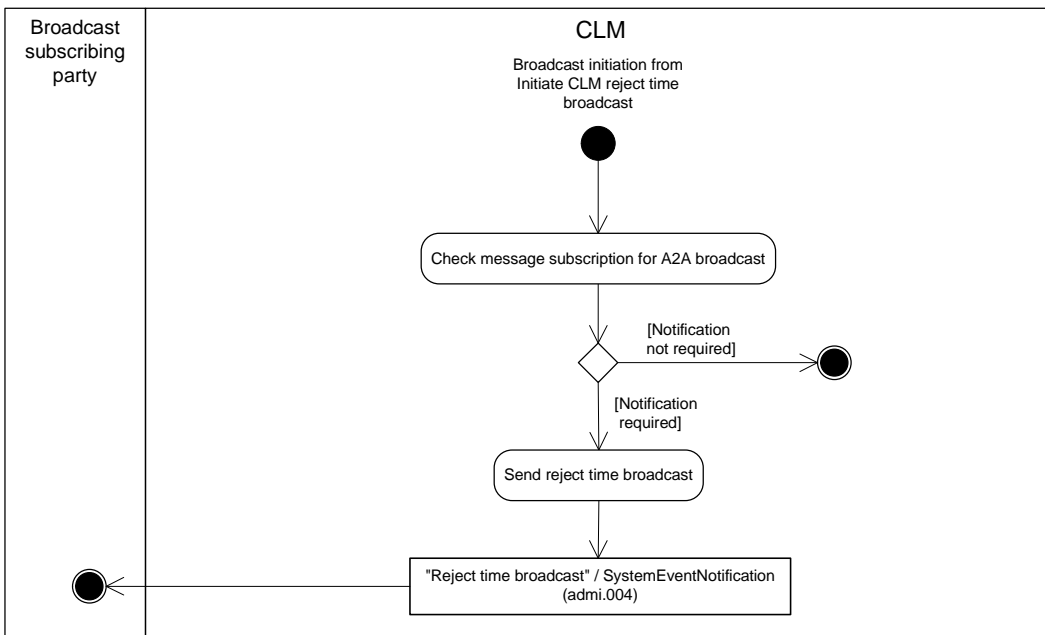

Figure 56 - Process CLM reject time broadcast

This sub-process is triggered by the process “[Initiate CLM reject time broadcast](#) [▶ 240]” and starts with the process step “Check message subscription for A2A broadcast”.

Check message subscription for A2A broadcast

This process step checks whether a message subscription for A2A broadcasts exists. In case such subscription exists, the processing continues with the step “Send reject time broadcast”.

Send reject time broadcast

This process step creates a "Reject time broadcast"/[SystemEventNotification \(admi.004\)](#) [▶ 365] and sends it to the broadcast subscribing party.

9.12.2 Messages

Message description/usage	ISO message	ISO code
Reject time broadcast	SystemEventNotification [▶ 365]	admi.004 [▶ 365]

Table 70 - Outbound messages for process CLM reject time broadcast

9.13 Settle connected payments

9.13.1 Description

This process is called for the settlement of a [Connected payment](#) [▶ 191]:

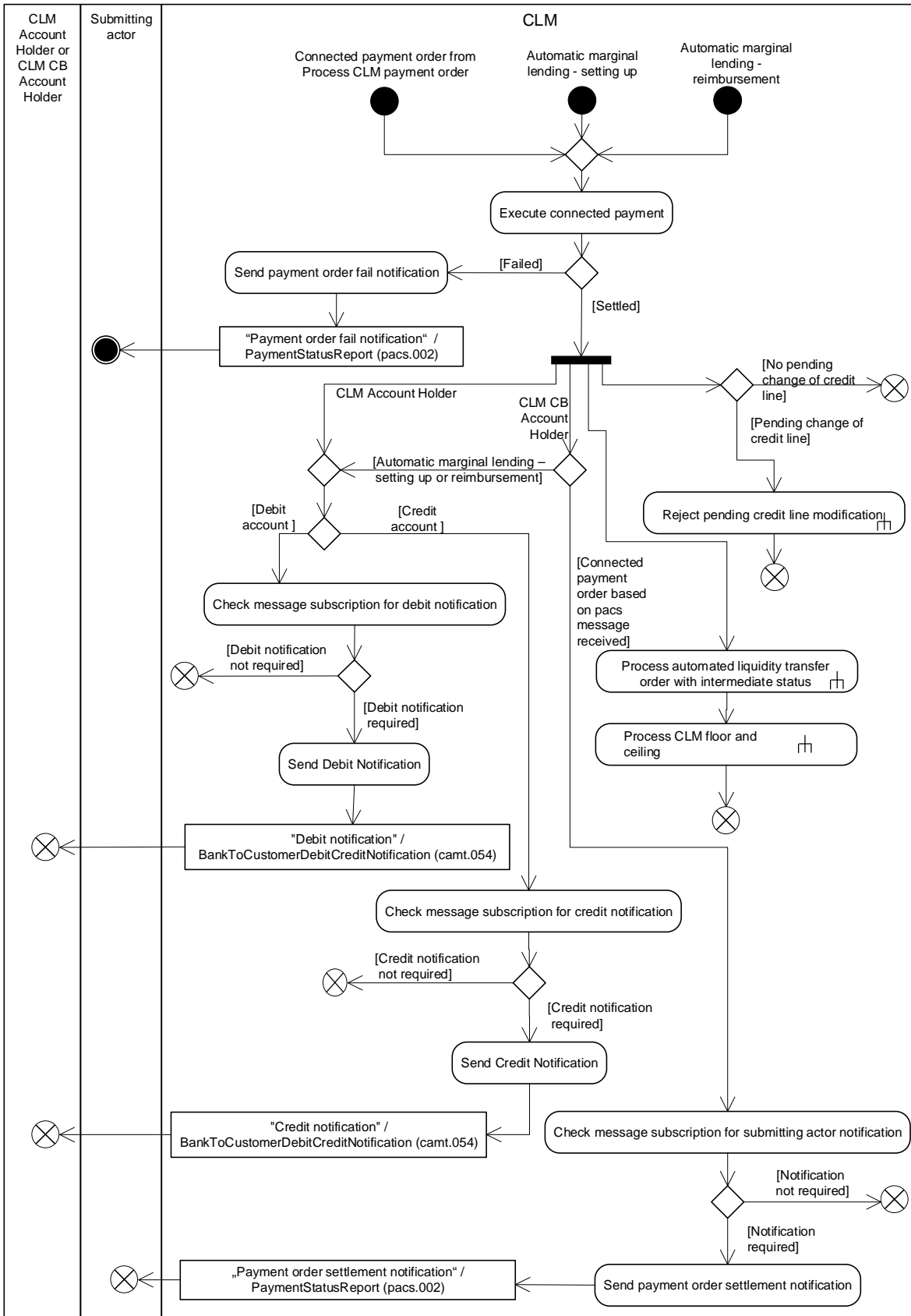

Figure 57 - Settle connected payments

One of the following events triggers the process step “Execute connected payment”:

- | a connected payment order, i.e. a [FinancialInstitutionCreditTransfer \(pacs.009\)](#) [▶ 624] or a [FinancialInstitutionDirectDebit \(pacs.010\)](#) [▶ 633], from the [Process CLM payment order and liquidity transfer order](#) [▶ 213];
- | an [automatic marginal lending set-up](#) [▶ 280] during the EOD processing;
- | an [automatic marginal lending - reimbursement](#) [▶ 282].

Execute connected payment

The outcome of the process step “Execute connected payment” triggers one of the following process steps (refer to chapter [Processing of cash transfer orders](#) [▶ 107] for further details).

- | **[Failed]** – The connected payment order failed. Automatic marginal lending set-up and the respective refund always settle and are on that basis not relevant for this possible processing result. The processing continues with “Send payment order fail notification”.
- | **[Settled]** – The process settles the connected payment order, i.e. settlement of the payment amount and change of the credit line. The processing continues with a split allowing the following parallel processing steps
 - sub-process [Process automated liquidity transfer order with intermediate status](#) [▶ 235] and afterwards with sub-process [Process CLM floor and ceiling](#) [▶ 237];
 - sub-process [Reject pending credit line modification](#) [▶ 252];
 - the processing for information to the CLM CB Account Holder and
 - the processing for information to the CLM Account Holder.

The processing for the CLM CB Account Holder continues with one of the following steps:

- | “Check message subscription for submitting actor notification” if the processing started with a received connected payment order;
- | “Check message subscription for debit notification” in case of an automatic marginal lending setting-up;
- | “Check message subscription for credit notification” in case of an automatic marginal lending reimbursement.

For the CLM Account Holder the processing continues with one of the following steps:

- | “Check message subscription for debit notification” in case the MCA is debited;
- | “Check message subscription for credit notification” in case the MCA is credited.

Send payment order fail notification

The process step creates a “Payment order fail notification”/[PaymentStatusReport \(pacs.002\)](#) [▶ 615] and sends it to the submitting actor.

Check message subscription for submitting actor notification

In case a message subscription is configured for the submitting actor notification, the processing continues with “Send payment order settlement notification”. Otherwise, CLM sends no notification.

Check message subscription for debit notification

In case a message subscription for the debit notification exists, the processing continues with “Send Debit Notification”. Otherwise, CLM sends no notification.

Send debit notification

The process step creates a "Debit notification"/[BankToCustomerDebitCreditNotification \(camt.054\)](#) [▶ 520] and sends it to the CLM Account Holder or CLM CB Account Holder.

Note: A CLM CB Account Holder receives such notification only in case of an automatic marginal lending set up.

Check message subscription for credit notification

In case a message subscription for the credit notification exists, the processing continues with “Send Credit Notification”. Otherwise, CLM sends no credit notification.

Send credit notification

The process step creates a "Credit notification"/[BankToCustomerDebitCreditNotification \(camt.054\)](#) [▶ 520] and sends it to the CLM Account Holder or CLM CB Account Holder.

Note: A CLM CB Account Holder receives such notification only in case of an automatic marginal lending reimbursement.

Send payment order settlement notification

The process step creates a “Payment order settlement notification”/[PaymentStatusReport \(pacs.002\)](#) [▶ 615] and sends it to the submitting actor.

9.13.2 Messages

Message description/usage	ISO message	ISO code
Payment order fail notification	PaymentStatusReport [▶ 615]	pacs.002 [▶ 615]
Payment order settlement notification	PaymentStatusReport [▶ 615]	pacs.002 [▶ 615]
Debit notification	BankToCustomerDebitCreditNotificatio n [▶ 520]	camt.054 [▶ 520]
Credit notification	BankToCustomerDebitCreditNotificatio n [▶ 520]	camt.054 [▶ 520]

Table 71 - Outbound messages for settle connected payments

9.14 Modify credit line

9.14.1 Description

This process triggers the modification of a credit line on an MCA.

Note: Connected payments may also be used for changing the credit line on an MCA. However, changing a credit line via a connected payment is covered by the process “[Settle connected payments](#) [▶ 243]”:

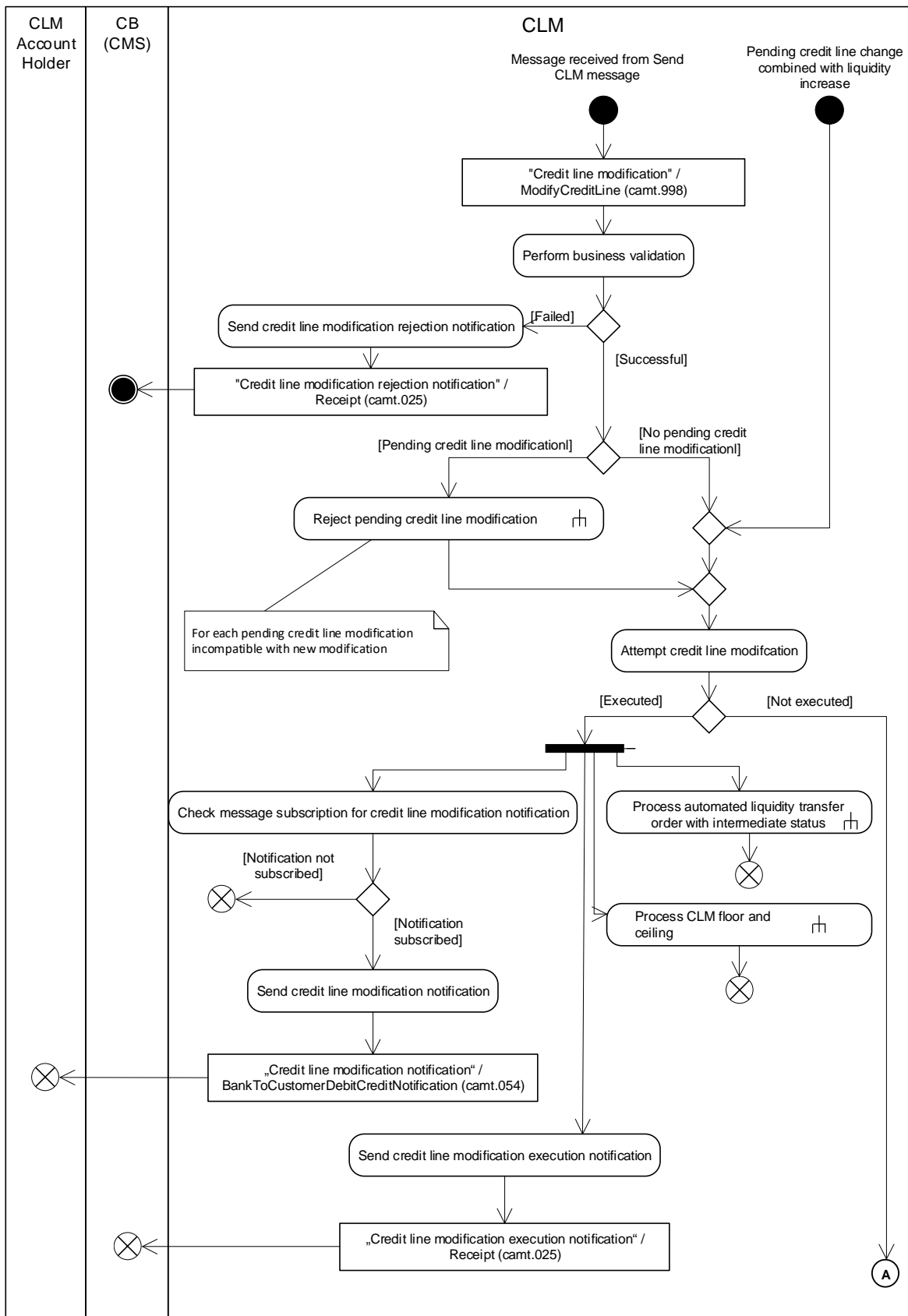

Figure 58 - Modify credit line I

CLM initiates this process in two cases:

- | a message is received from the process “Send CLM message”;
- | a pending credit line change combined with a liquidity increase.

In case of a message received, the process continues with the step “Perform business validations”.

In case of pending credit line change combined with a liquidity increase, the process continues with the step “Attempt credit line modification”.

Perform business validations

The process verifies whether a credit line modification request is compliant with the business validation rules. The process performs the business validations to the extent possible in order to report as many as possible validation errors to the submitting actor.

- | **[Failed]** The credit line modification request is not compliant with the business validation rules. The processing continues with “Send credit line modification rejection notification”.
- | **[Successful]** The credit line modification request complies with the business validation rules. In case a pending credit line modification is incompatible with the new modification, the processing continues with the sub-process “[Reject pending credit line modification](#) [▶ 252]”. Afterwards, the process continues with the step “Attempt credit line modification”.

Note: Only pending delta credit line modifications are compatible with new delta credit line modifications. Several delta credit line modifications can be pending in parallel, but all pending delta credit line modifications for one MCA are rejected, if a fixed amount credit line modification is received.

Further details on credit line management are provided in chapter [Credit line management](#) [▶ 190].

Send credit line modification rejection notification

CLM rejects the request and sends a "Credit line modification rejection notification"/[Receipt \(camt.025\)](#) [▶ 479] to the CB (local CMS⁷⁶).

Attempt credit line modification

CLM attempts to update the credit line on the MCA.

There are two possible results of this process:

- | **[Executed]** The processing continues after the modification of credit line with a split allowing the following parallel steps:
 - “Check message subscription for credit line modification notification”;
 - “Send credit line modification execution notification”;

⁷⁶ Credit line modifications in EUR using [ModifyCreditLine \(camt.998\)](#) [▶ 578] from local CMS are only allowed until ECMS go-live.

- sub-[Process automated liquidity transfer order with intermediate status](#) [▶ 235] and
- sub-[Process CLM floor and ceiling](#) [▶ 237].

I **[Not executed]** In case it is not possible to decrease the credit line (as credit line increases are always processed), the credit line modification is set to status "pending" and the processing continues with "A".

Check message subscription for credit line modification notification

In case a message subscription for the credit line modification notification exists, the processing continues with "Send credit line modification notification". Otherwise, CLM sends no notification.

Send credit line modification notification

The process step creates a "Credit line modification notification"/[BankToCustomerDebitCreditNotification \(camt.054\)](#) [▶ 520] and sends it to the CLM Account Holder.

Send credit line modification execution notification

The process step creates a "Credit line modification execution notification"/[Receipt \(camt.025\)](#) [▶ 479] and sends it to the CB (local CMS⁷⁷).

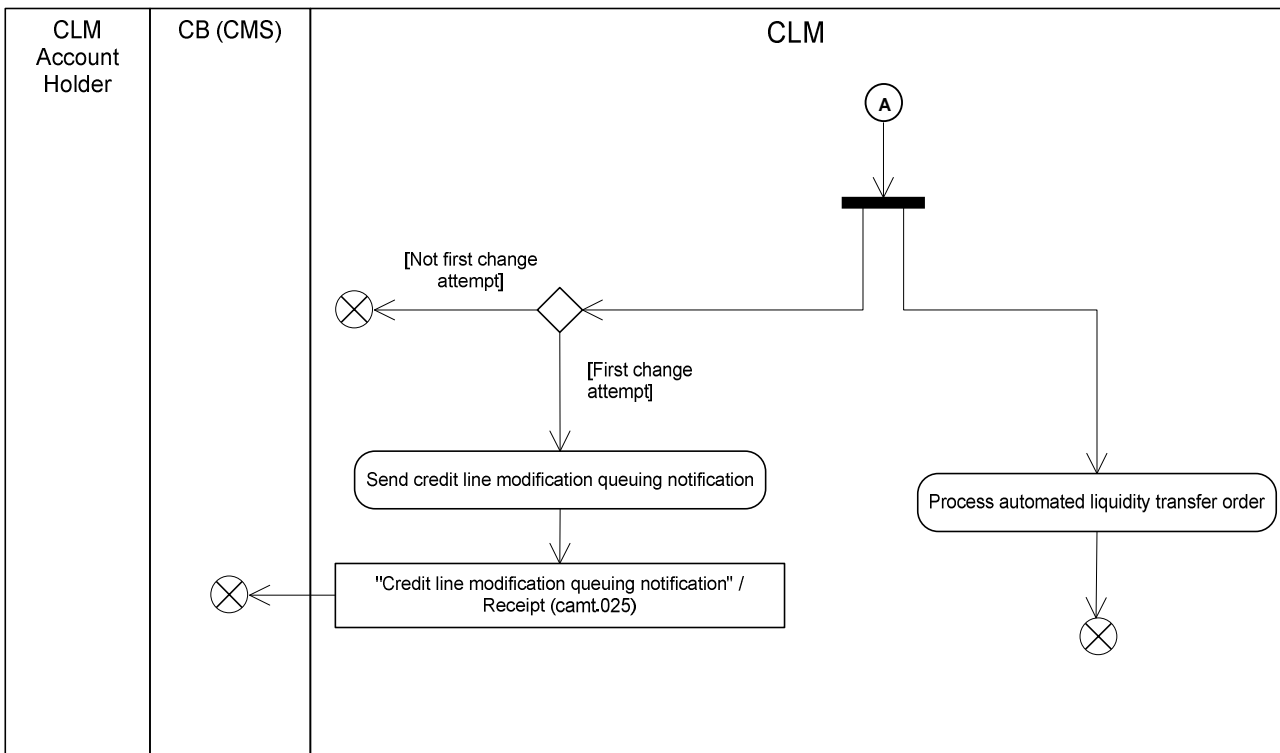

Figure 59 - Modify credit line II

The processing continues with a split into the following processing steps.

77 Credit line modifications in EUR using [ModifyCreditLine \(camt.998\)](#) [▶ 578] from local CMS are only allowed until ECMS go-live.

- | If it is the first attempt to modify the credit line, the processing continues with the processing step “Send credit line modification queuing notification”. If it is not the first attempt to modify the credit line, the processing finishes.
- | The processing continues with “Process automated liquidity transfer order”.

Send credit line modification queuing notification

CLM notifies the CB of the failed execution after the first attempt only and sends a "Credit line modification queuing notification"/[Receipt \(camt.025\)](#) [▶ 479] to the CB (local CMS⁷⁸).

Process automated liquidity transfer order

After the first settlement attempt of a credit line modification, the automated liquidity transfer processing may create an automated liquidity transfer order. Further details can be found in chapter [Automated liquidity transfer due to queued/pending CBO](#) [▶ 129].

9.14.2 Messages

Message description/usage	ISO message	ISO code
Credit line modification	ModifyCreditLine [▶ 580]	camt.998 [▶ 580]

Table 72 - Inbound messages for modify credit

Message description/usage	ISO message	ISO code
Credit line modification rejection notification	Receipt [▶ 479]	camt.025 [▶ 479]
Credit line modification notification	BankToCustomerDebitCreditNotification [▶ 520]	camt.054 [▶ 520]
Credit line modification execution notification	Receipt [▶ 479]	camt.025 [▶ 479]
Credit line modification queuing notification	Receipt [▶ 479]	camt.025 [▶ 479]

Table 73 - Outbound messages for modify credit line

78 Credit line modifications in EUR using [ModifyCreditLine \(camt.998\)](#) [▶ 578] from local CMS are only allowed until ECMS go-live.

9.15 Reject pending credit line modification

9.15.1 Description

This sub-process removes a pending credit line modification:

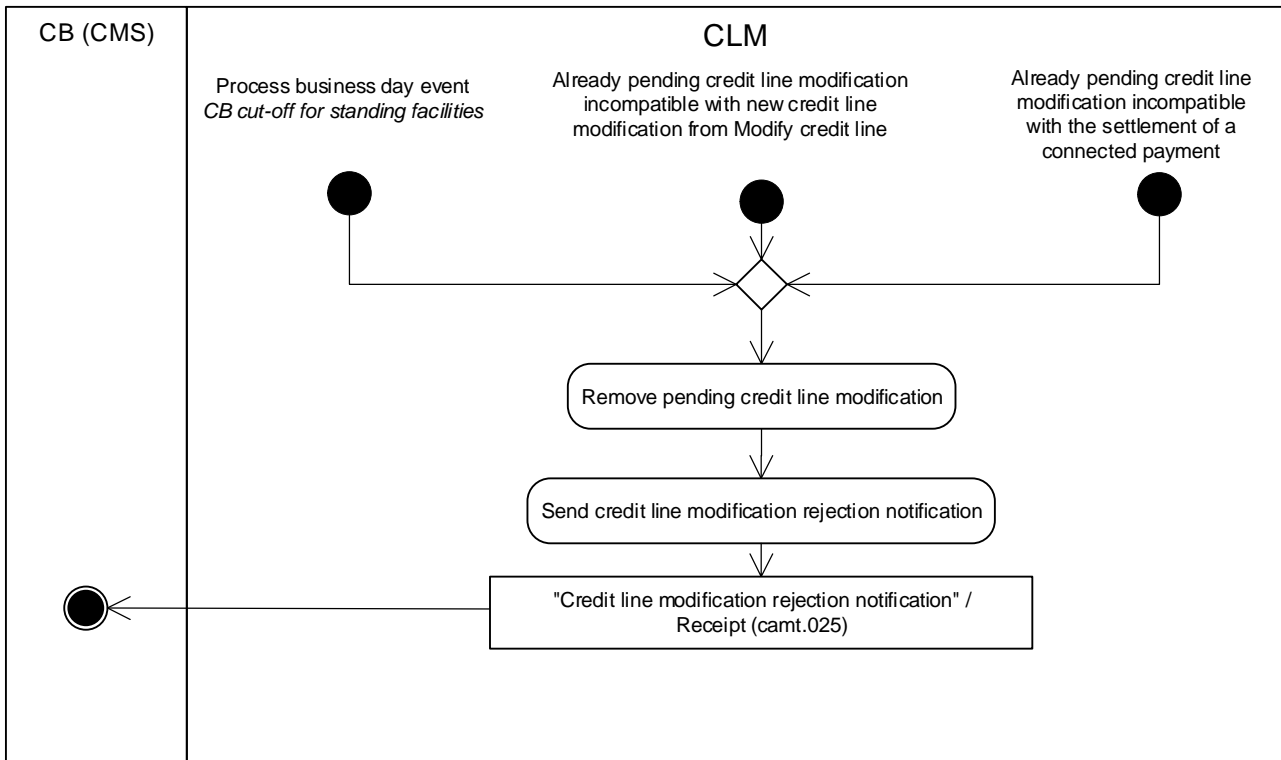

Figure 60 - Reject pending credit line modification

This sub-process is triggered either by:

- | The [Process business day event "CB cut-off for standing facilities"](#) [▶ 272];
- | the existence of a pending credit line modification from the process "[Modify credit line](#) [▶ 247]";
- | the existence of a pending credit line modification incompatible with the settlement of a [Connected payment](#) [▶ 191].

The sub-process starts with the process step "Remove pending credit line modification".

Remove pending credit line modification

This process step removes the pending credit line modification and the processing continues with "Send credit line modification rejection notification".

Send credit line modification rejection notification

The process step creates a "Credit line modification rejection notification"/[Receipt \(camt.025\)](#) [▶ 479] and sends it to the CB (local CMS⁷⁹).

9.15.2 Messages

Message description/usage	ISO message	ISO code
Credit line modification rejection notification	Receipt [▶ 479]	camt.025 [▶ 479]

Table 74 - Outbound messages for reject pending credit line modification

9.16 Manage current reservation in CLM

9.16.1 Description

This process triggers the modification or deletion of a current reservation in CLM. "Modification" of a current reservation also includes the set-up of a current reservation with immediate effect for the current business day:

79 Credit line modifications in EUR using [ModifyCreditLine \(camt.998\)](#) [▶ 578] from local CMS are only allowed until ECMS go-live.

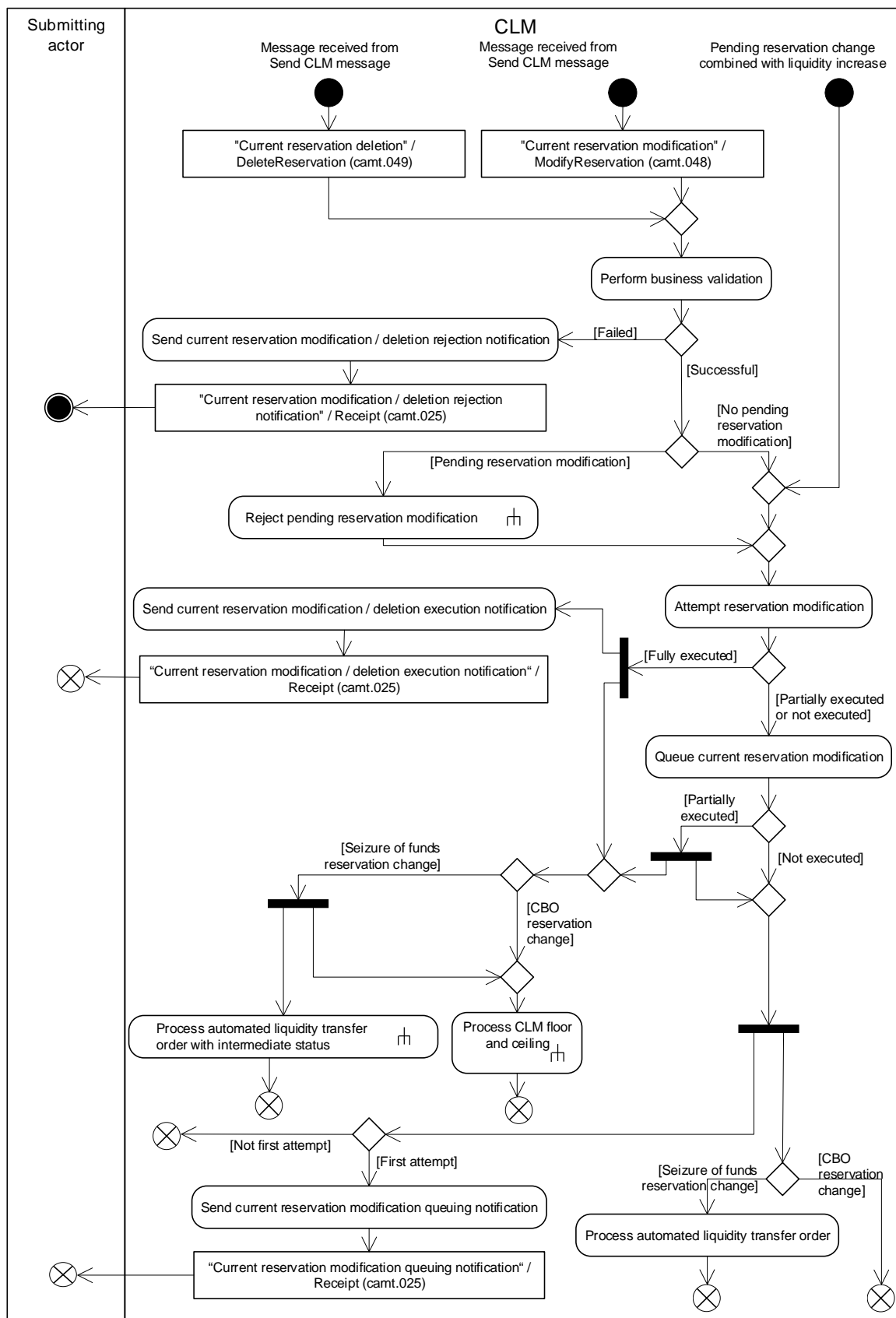

Figure 61 - Manage current reservation

CLM initiates this process when it receives:

- | a message from the process "Send CLM message" to delete a current reservation ([DeleteReservation \(camt.049\)](#) [▶ 502]);
- | a message from the process "Send CLM message" to modify a current reservation ([ModifyReservation \(camt.048\)](#) [▶ 499]);
- | the notification of a liquidity increase on the MCA in case of pending reservation.

The processing continues with the process step "Perform business validation" when it receives a message from the process "Send CLM message". Otherwise the processing continues with the process step "Attempt reservation modification".

For details on reservations see [Liquidity reservation](#) [▶ 130].

Perform business validations

The process step verifies whether a current reservation deletion request or a current reservation modification request is compliant with the business validation rules. It performs the business validations to the extent possible in order to report the maximum number of validation errors to the submitting actor.

- | **[Failed]** The current reservation deletion request or a current reservation modification request is not compliant with the business validation rules. The processing continues with "Send current reservation modification/deletion rejection notification".
- | **[Successful]** The current reservation deletion request or a current reservation modification request complies with the business validation rules. If a pending reservation modification exists, the processing triggers the sub-process "[Reject pending reservation modification in CLM](#) [▶ 257]". The processing continues with "Attempt reservation modification".

Send current reservation modification / deletion rejection notification

CLM rejects the request and sends a "Current reservation modification/deletion rejection notification"/[Receipt \(camt.025\)](#) [▶ 479] to the submitting actor.

Attempt reservation modification

In case CLM attempts to modify the reservation, there are two possible outcomes:

- | full execution of the modification or deletion;
- | partial execution or no execution of the modification.

In case of a deletion of a reservation, CLM always fully executes the order.

For the full execution of a reservation modification request or a reservation deletion request, the processing continues with a split allowing parallel processing of the

- | step "Send current reservation modification / deletion execution notification";

- I sub-“[Process CLM floor and ceiling](#) [▶ 237]”⁸⁰ and
- I sub-“[Process automated liquidity transfer order with intermediate status](#) [▶ 235]” in case of seizure of funds reservation change.

The processing finishes with these sub-processes.

If the attempt to execute the reservation modification request results in a partial execution or no execution the processing continues with step “Queue current reservation modification”.

Queue current reservation modification

CLM queues the modification for further processing and the processing continues with a split into the following processing steps.

- I Only on the first attempt to modify the reservation, the processing continues with the processing step “Send current reservation modification queuing notification”. If it is not the first attempt to modify the reservation, the processing finishes.
- I In case of seizure of funds reservation change the processing continues in parallel with the processing step “Process automated liquidity transfer order”.
- I In case of partial execution the processing continues in parallel with the sub-“[Process CLM floor and ceiling](#) [▶ 237]”⁸¹
- I In case of partial execution of seizure of funds reservation change the processing continues in parallel with the sub-“[Process automated liquidity transfer order with intermediate status](#) [▶ 235]”.

Note: In case the available liquidity on the MCA increases, a pending seizure of funds reservation is always executed prior to a pending reservation for CBOs.

Send current reservation modification/deletion execution notification

CLM executes the request and sends a "Current reservation modification/deletion execution notification"/[Receipt \(camt.025\)](#) [▶ 479] to the submitting actor.

Note: In the very exceptional case that the execution of a seizure of funds reservation leads to a reduction of an already existing CBO reservation, no modification/deletion execution notification will be sent to the CLM Account Holder.

Send current reservation modification queuing notification

CLM sends a "Current reservation modification queuing notification"/[Receipt \(camt.025\)](#) [▶ 479] to the submitting actor.

80 The sub-process CLM floor and ceiling executes for seizure of funds reservation change a floor and ceiling check and for CBO reservation change a ceiling check only.

81 The sub-process CLM floor and ceiling executes for the seizure of funds reservation change a floor check only.

Process automated liquidity transfer order

After the reservation modification attempt, the automated liquidity transfer processing may create an automated liquidity transfer order and the processing finishes. Further details can be found in chapter [Automated liquidity transfer due to queued/pending CBO](#) [▶ 129].

9.16.2 Messages

Message description/usage	ISO message	ISO code
Current reservation deletion	DeleteReservation [▶ 502]	camt.049 [▶ 502]
Current reservation modification	ModifyReservation [▶ 499]	camt.048 [▶ 499]

Table 75 - Inbound messages for manage current reservation

Message description/usage	ISO message	ISO code
Current reservation modification/deletion rejection notification	Receipt [▶ 479]	camt.025 [▶ 479]
Current reservation modification/deletion execution notification	Receipt [▶ 479]	camt.025 [▶ 479]
Current reservation modification queuing notification	Receipt [▶ 479]	camt.025 [▶ 479]

Table 76 - Outbound messages for manage current reservation

9.17 Reject pending reservation modification in CLM

9.17.1 Description

This sub-process removes a pending reservation change from processing:

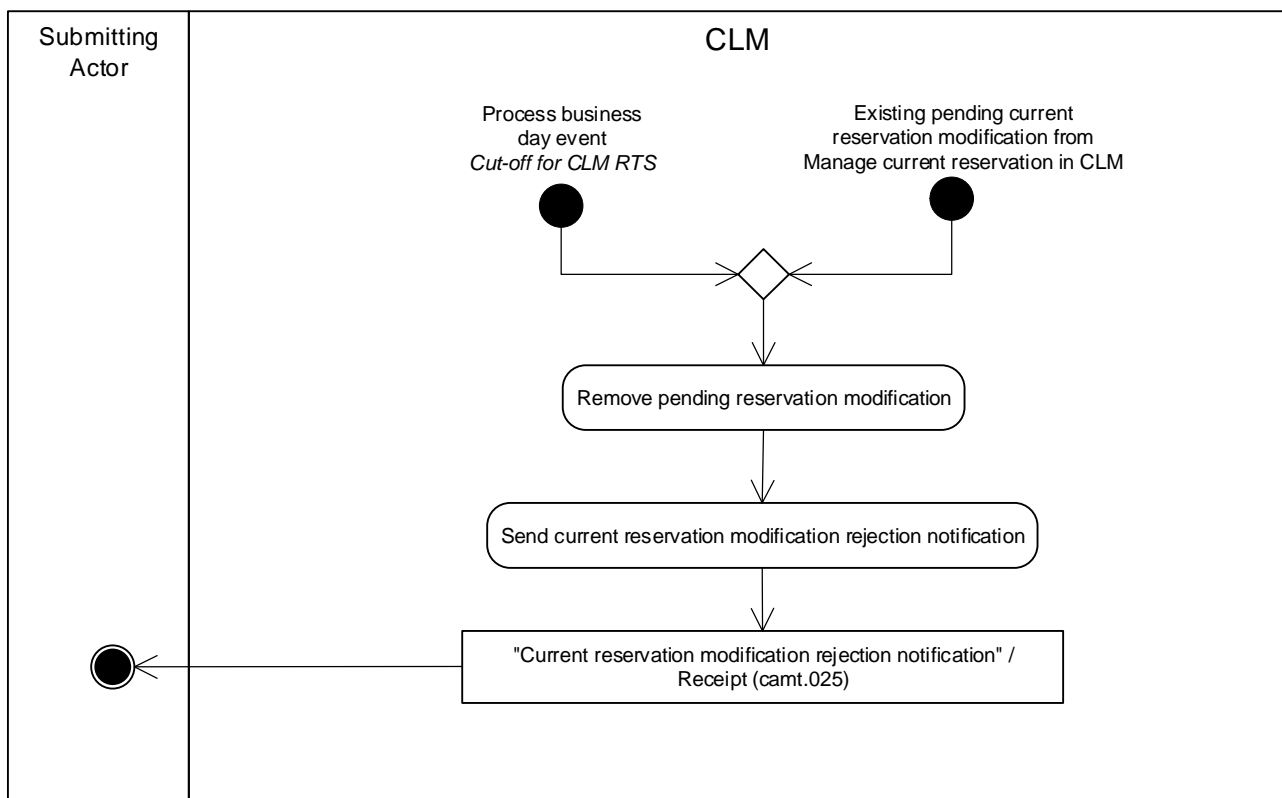

Figure 62 - Reject pending reservation modification

This sub-process is triggered either by:

- I the [Process business day event "Cut-off for CLM RTS"](#) [▶ 270];
- I the existence of a pending current reservation from the process "[Manage current reservation in CLM](#) [▶ 253]".

The sub-process starts with the process step "Remove pending reservation modification". For details on reservations see [Liquidity reservation](#) [▶ 130].

Remove pending reservation modification

This process step removes the pending reservation modification and the processing continues with the step "Send current reservation modification rejection notification".

Send current reservation modification rejection notification

The process step creates a "Current reservation modification rejection notification"/[Receipt \(camt.025\)](#) [▶ 479] and sends it to the submitting actor.

9.17.2 Messages

Message description/usage	ISO message	ISO code
Current reservation modification rejection notification	Receipt [▶ 479]	camt.025 [▶ 479]

Table 77 - Outbound messages for reject pending reservation modification in CLM

9.18 Reject payment order

9.18.1 Description

This sub-process rejects a payment order and sends a rejection notification for the payment order to the submitting actor:

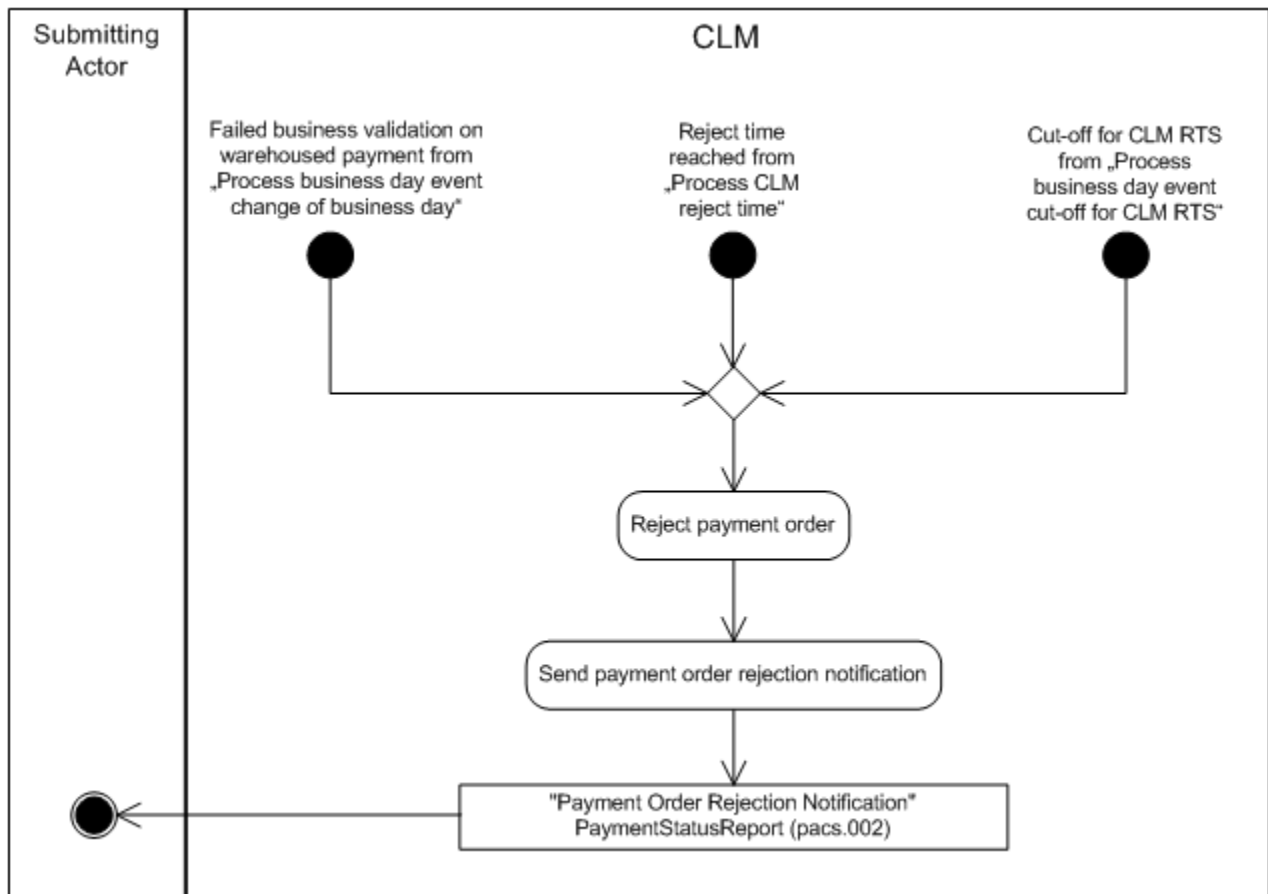

Figure 63 - Reject payment order

This subprocess is called when:

- a rejection of a queued payment order takes place after event ["Cut-off for CLM RTS processing"](#) [▶ 270];

- | a warehoused payment order fails revalidation at the SoD (see [Process business day event “Change of business day”](#) [▶ 267]);
- | a payment order is still queued when reaching its reject time ([Process CLM reject time](#) [▶ 239]).

Reject payment order

This processing step rejects the payment order and subsequently the processing continues with “Send payment order rejection notification”.

Send payment order rejection notification

This processing step sends the "Payment order rejection notification"/[PaymentStatusReport \(pacs.002\)](#) [▶ 615] to the submitting actor.

9.18.2 Messages

Message description/usage	ISO message	ISO code
Payment order rejection notification	PaymentStatusReport [▶ 615]	pacs.002 [▶ 615]

Table 78 - Outbound message for reject payment order

9.19 Process interest for accounts subject to interest calculation

This sub-process triggers the daily calculation of the average balance for the respective remuneration period by taking into account the EoD balance of the respective account. This is not limited to cash accounts in CLM, but can be subject to all types of cash accounts for which respective information is provided to CLM.

Furthermore, it triggers the calculation of interest and – if required – respective payment initiation at:

- | the end of the minimum reserve maintenance period;
- | the end of the month.

Further details can be found in chapter [Minimum reserve management and interest calculation](#) [▶ 139].

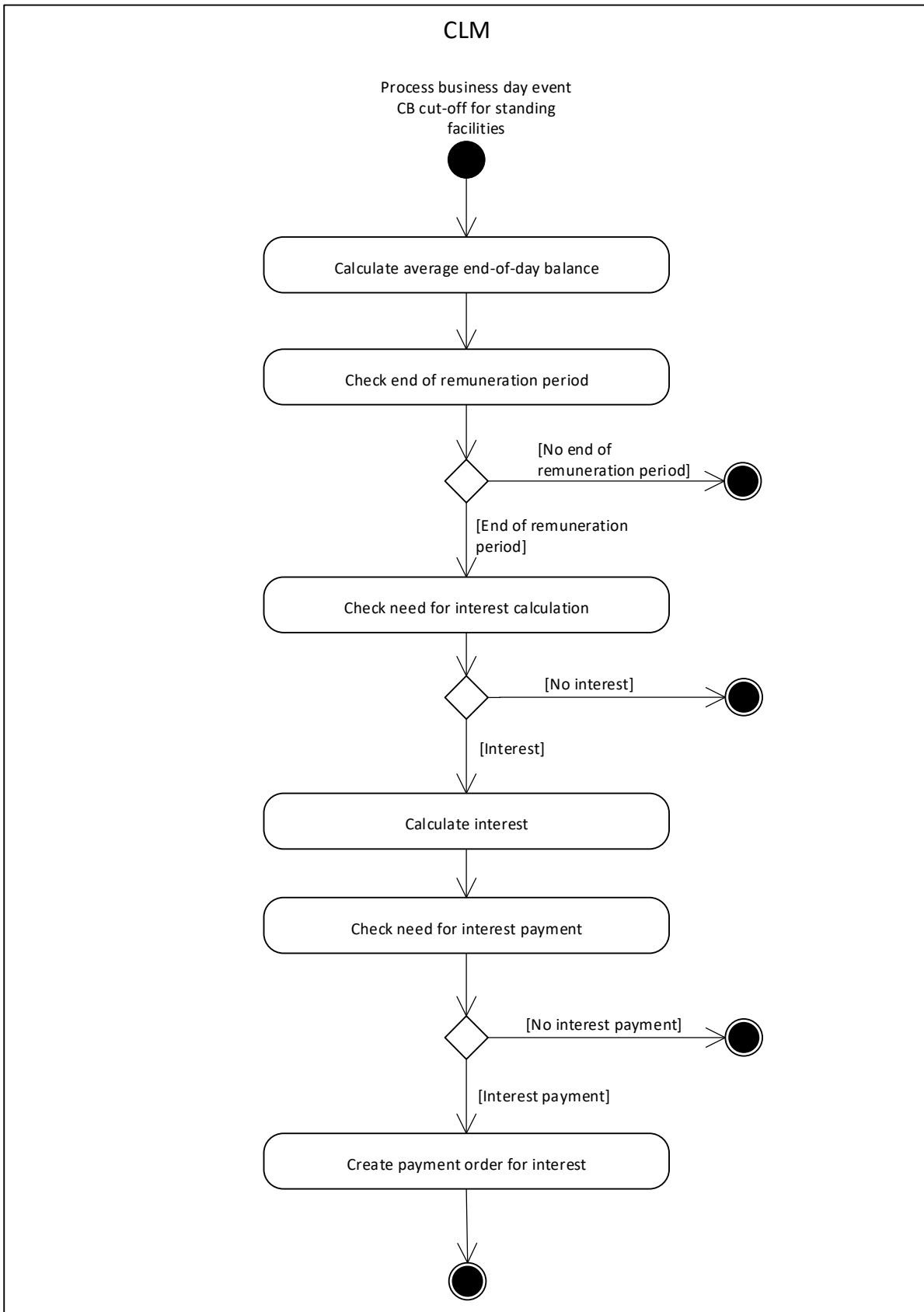

Figure 64 - Process interest for accounts subject to interest calculation

CLM initiates this sub-process during “CB cut-off for standing facilities” processing (see [Process business day event “CB cut-off for standing facilities”](#) [▶ 272]).

Calculate average EoD balance

On a daily basis, this processing step calculates the average EoD balance for every relevant cash account and the processing continues with “Check on end of remuneration period”.

Check on end of remuneration period

The process step checks if the end of the remuneration period is reached. The remuneration period is either:

- | the minimum reserve maintenance period;
- | a month.

The processing continues as follows:

- | in case it is the last business day of the remuneration period, the processing continues with “Check need for interest calculation”;
- | in case it is not the last business day of the remuneration period, the processing terminates.

Check need for interest calculation

The process step checks if interest need to be calculated.

Interest has to be calculated if:

- | the interest rate to be considered is not equal to zero;
- | the average EoD balance for the relevant cash account to be considered is not equal to zero.

The processing continues as follows:

- | in case no interest calculation is necessary, the processing terminates;
- | in case an interest calculation is necessary, the processing continues with “Calculate interest”.

Calculate interest

The process step calculates the interest with the relevant interest rate and the process continues with “Check need for interest payment”.

Check need for interest payment

The process step checks if an interest payment needs to be created according to the reference data of the respective account:

- | in case no interest payment is necessary, the processing terminates;
- | in case an interest payment is necessary, the processing continues with “Create interest payment order”.

Create interest payment order

This processing step creates the payment order for interest with value date two business days after the end of the respective remuneration period and with status “warehoused”. The further processing is described in [Process business day event “Change of business day”](#) [▶ 267].

9.20 Coordinate general ledger creation with other settlement services

9.20.1 Description

CLM initiates this sub-process when the event “Start of EoD processing” is reached. This sub-process is triggered for each settlement service and currency on each business day:

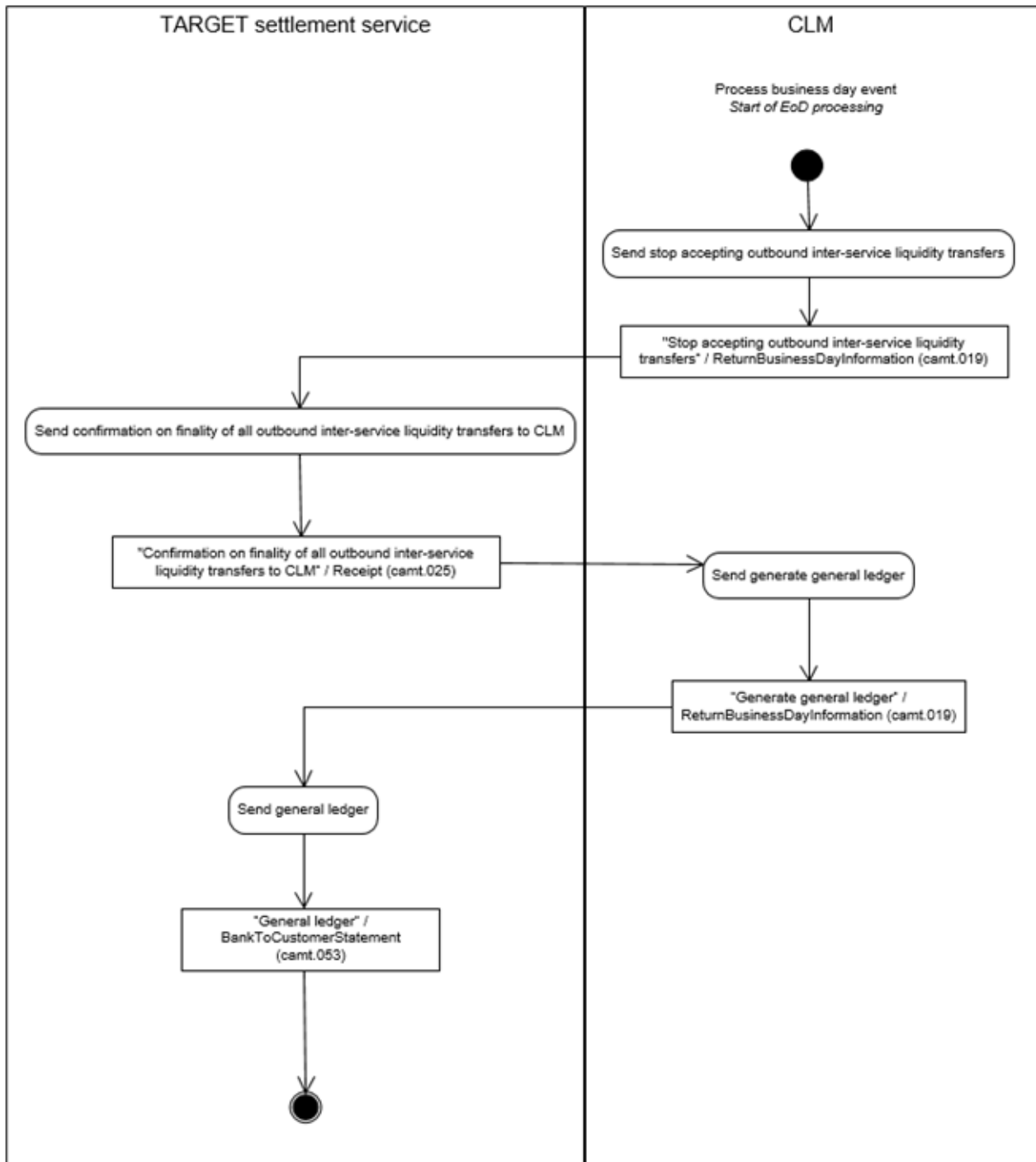

Figure 65 - Coordinate general ledger creation with other settlement services

Send stop accepting outbound inter-service liquidity transfers

After the “Start of EoD processing” in CLM is reached, CLM sends a "Stop accepting outbound inter-service liquidity transfers"/ReturnBusinessDayInformation (camt.019) to the settlement service.

Send confirmation on finality of all outbound inter-service liquidity transfers to CLM

After the reception of the "Stop accepting outbound inter-service liquidity transfers"/ReturnBusinessDayInformation (camt.019) the settlement service stops accepting outbound inter-service liquidity transfers to CLM from external actors. Outbound inter-service liquidity transfers due to standing order liquidity transfer orders are still possible for some settlement services, e.g. for RTGS after the last settlement attempt. When all outbound inter-service liquidity transfers sent by this settlement service have been answered by CLM and the CLM responses have been finally processed by the settlement service (this includes reversal settlement in case of rejection by the receiving settlement service), the settlement service sends a "Confirmation on finality of all outbound inter-service liquidity transfers to CLM"/Receipt (camt.025) to CLM.

Send generate general ledger

After the reception of the "Confirmation on finality of all outbound inter-service liquidity transfers to CLM"/Receipt (camt.025) CLM checks whether all other settlement services have confirmed that there are no unanswered outbound inter-service liquidity transfers. If this is the case CLM sends a "Generate general ledger"/ReturnBusinessDayInformation (camt.019) to the settlement service.

Send general ledger

After the reception of the "Generate general ledger"/ReturnBusinessDayInformation (camt.019) the settlement service can start creating the general ledger. It must be ensured by the settlement service that no further transactions for the business date and currency reported in the general ledger to be created are settled. The settlement service sends the "General ledger"/BankToCustomerStatement (camt.053) to CLM.

9.20.2 Messages

Use case	Message description/usage	ISO message	ISO code
Send stop accepting outbound inter-service liquidity transfers	Stop accepting outbound inter-service liquidity transfers	ReturnBusinessDayInformation	camt.019
Send confirmation on finality of all outbound inter-service liquidity transfers to CLM	Confirmation on finality of all outbound inter-service liquidity transfers to CLM	Receipt	camt.025
Send generate general ledger to the settlement services	Generate general ledger	ReturnBusinessDayInformation	camt.019
Send general ledger to CLM	General ledger	BankToCustomerStatement	camt.053

Table 79 - Used messages to coordinate general ledger creation with other settlement services

9.21 Process cross-CB turnover

This sub-process triggers the calculation of the position of each individual CB vis-à-vis the Eurosystem:

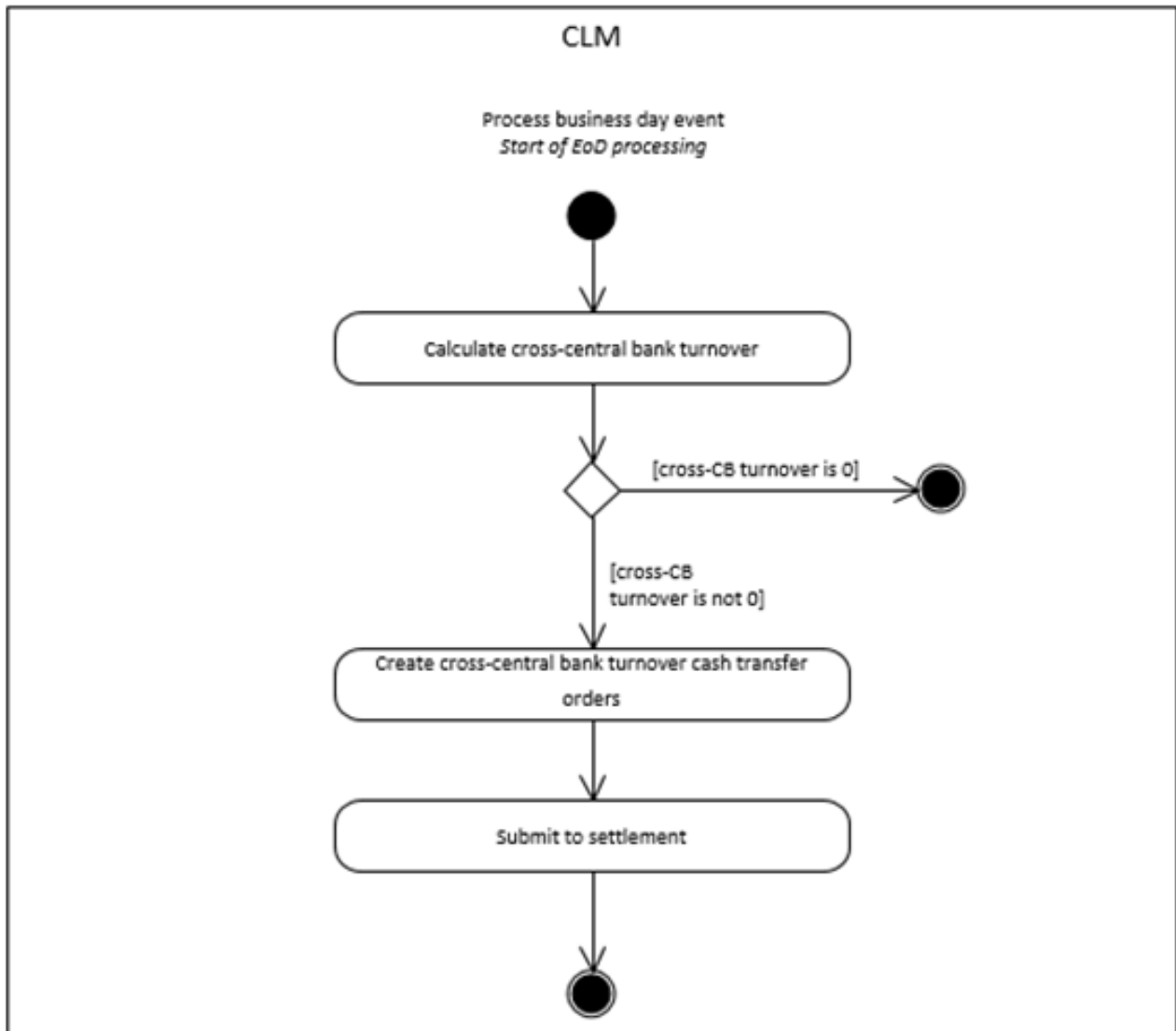

Figure 66 - Process cross-CB turnover

CLM initiates this sub-process during “Start of EoD processing” processing.

The processing continues with the process step “Calculate cross-CB turnover”.

Calculate cross-CB turnover

The process step calculates the positions between the CBs. Further details on cross-CB turnover can be found in chapter [Cross-CB turnover](#) [▶ 197]:

- I in case the cross-CB turnover is zero, the processing terminates;

-
- I in case the cross-CB turnover is different from zero, the processing continues with “Create cross-CB turnover cash transfer order”.

Create cross-CB turnover cash transfer orders

The process step generates the cross-CB turnover cash transfer orders (i.e. one for posting on the CB ECB accounts and one for the corresponding ECB mirror accounts) and the process continues with “Submit to settlement”.

Submit to settlement

This processing step submits the cross-CB turnover cash transfer order to the process [Perform standard CLM settlement](#) [▶ 223].

9.22 Business day event processes

The processes described in this chapter are all started by business day events. Further details on the business day and the related events can be found in chapter [Business day](#) [▶ 73].

9.22.1 Process business day event “Change of business day”

As the reference data updates become effective in CLM as of the start of a new business day, CLM revalidates each warehoused payment order at the start of every business day after the event “Change of business day” in order to ensure that the payment orders still comply with the business validation rules:

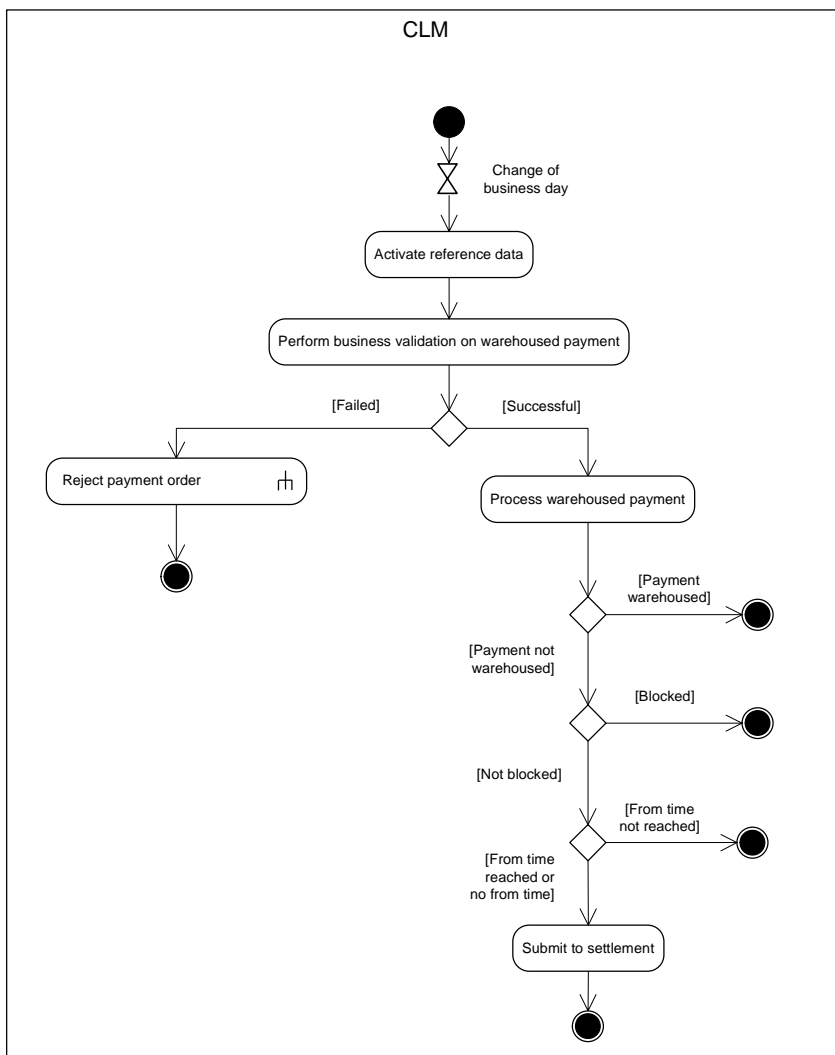

Figure 67 - Process business day event “Change of business day”

The event “Change of business day” triggers the processing step “Active reference data”.

Activate reference data

The processing step activates the reference data in CLM which were loaded during the EoD period of the previous business day. After activation, the processing continues with the processing step “Perform business validation” for each warehoused payment order.

Perform business validation on warehoused payment

The process verifies whether the warehoused payment order remains compliant with the business validation rules after the reference data updates are activated in CLM. The process performs the business validations to the extent possible in order to report the maximum number of validation errors to the submitting actor.

- I **[Failed]** The warehoused payment order is not compliant with the business validation rules. The processing continues with the sub-process “[Reject payment order](#) [▶ 259]”.

-
- I **[Successful]** The warehoused payment order remains compliant with the business validation rules. The processing continues with the process step “Process warehoused payment order”.

Process warehoused payment order

This processing step determines the state to which the payment order must be set after the successful business validation. If the intended settlement date of the payment order is after the current business day, then processing step sets the payment order to “warehoused”. Otherwise, the processing step checks if blocking is applicable. If the blocking check described in chapters [Blocking/unblocking party](#) [▶ 47] and [Blocking/unblocking account](#) [▶ 60] results in blocking of the payment order, then the processing step sets the payment order to “earmarked”. Otherwise, the processing step checks if an earliest debit time indicator (FromTime) was set. If the set FromTime is not reached, then the processing step sets the payment order to “earmarked”.

Otherwise the processing continues with the step “Submit to settlement”.

Submit to settlement

This processing step submits the payment order to the process “[Perform standard CLM settlement](#) [▶ 223]”. The settlement attempt takes place when the [settlement window for CBOs](#) [▶ 80] is opened.

9.22.2 Process business day event “Start of CLM RTS”

This process is valid only until ECMS go-live. After ECMS go-live CLM will only perform the reimbursement of the automatic marginal lending. The reimbursement of marginal lending on request and the interest payments for both marginal lending on request and automatic marginal lending will be processed by ECMS, and send as other monetary policy operations to CLM (either connected or regular payments).

This process serves as basis for all sub-processes to be initiated after event “Start of CLM RTS”:

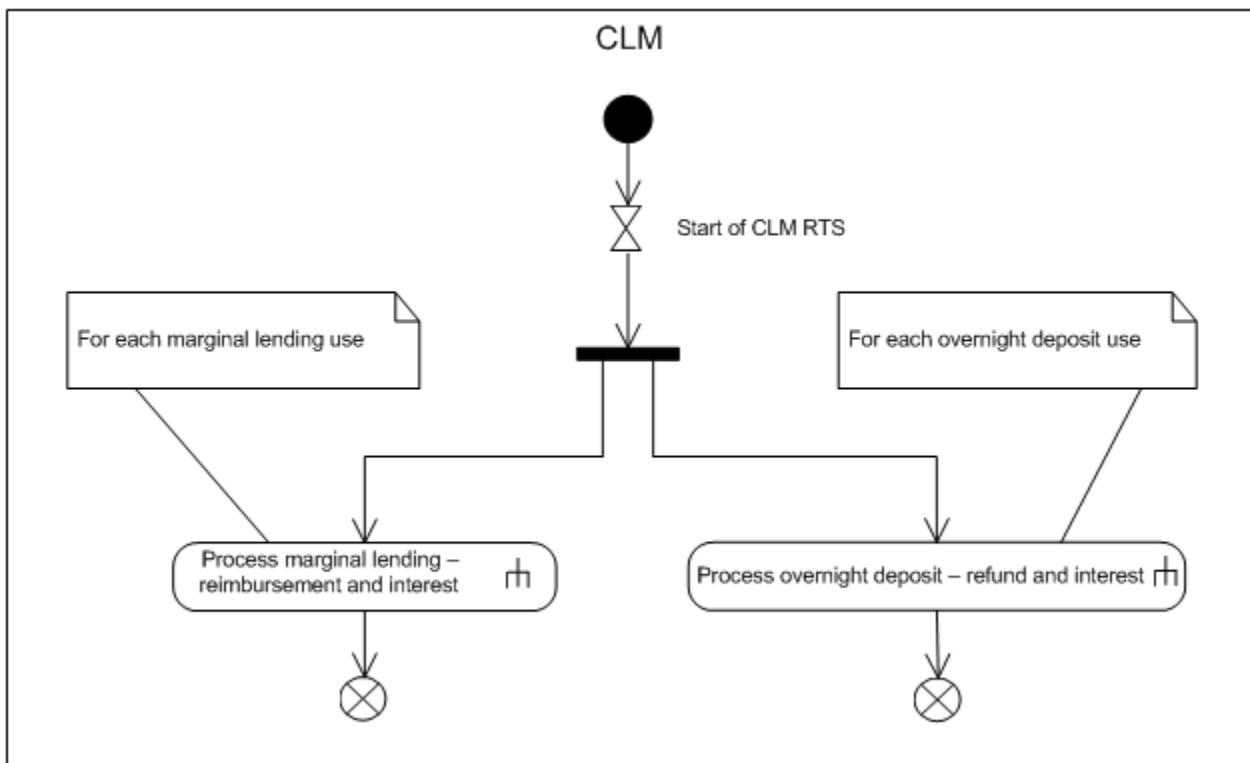

Figure 68 - Process business day event “Start of CLM RTS”

The time-based event “Start of CLM RTS” triggers the processing, which subsequently results in the parallel triggering of the following sub-processes:

- I [Process overnight deposit - refund and interest](#) [▶ 276] for each overnight deposit use;
- I [Process marginal lending - reimbursement and interest](#) [▶ 282] for each marginal lending use.

9.22.3 Process business day event “Cut-off for CLM RTS”

This process serves as basis for all sub-processes to be initiated after the event “Cut-off CLM RTS”.

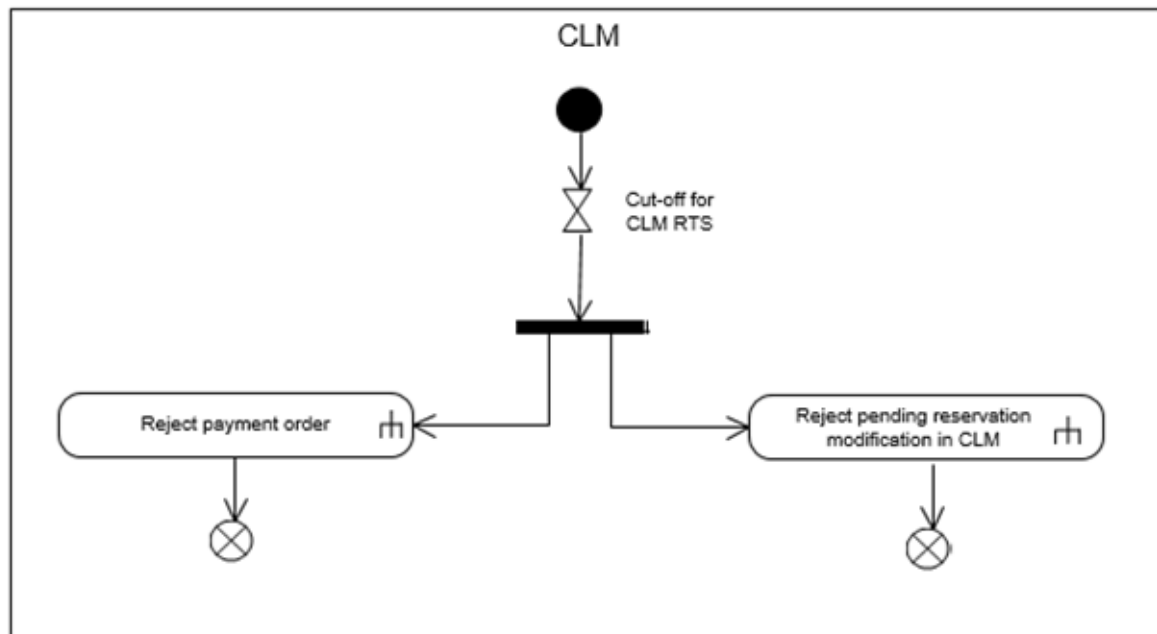

Figure 69 - Process business day event “Cut-off for CLM RTS”

The time-based event “Cut-off CLM RTS” triggers the closure processing, which subsequently results in the parallel triggering of the following sub-processes:

- I [“Reject payment order \[▶ 259\]”](#);
- I [“Reject pending reservation modification in CLM \[▶ 257\]”](#).

9.22.4 Process business day event “Start of EoD processing”

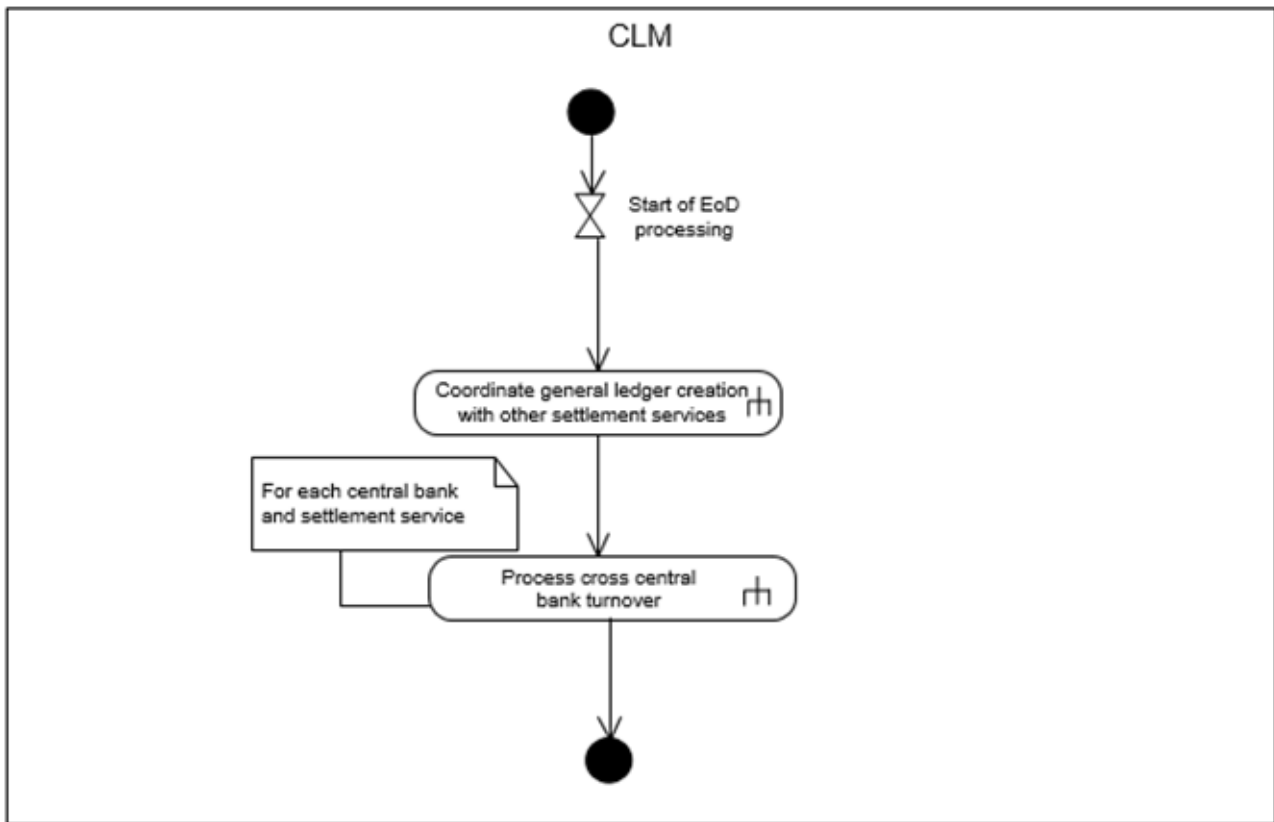

Figure 70 - Process business day event “Start of EoD processing

The not time-based event “Start of EoD processing” triggers the end of day activities with following sub-processes:

- I “Coordinate general ledger with other settlement services”;
- I “Process of cross central bank turnover”

9.22.5 Process business day event “CB cut-off for standing facilities”

This process serves as basis for all sub-processes to be initiated after the event “CB cut-off for standing facilities”:

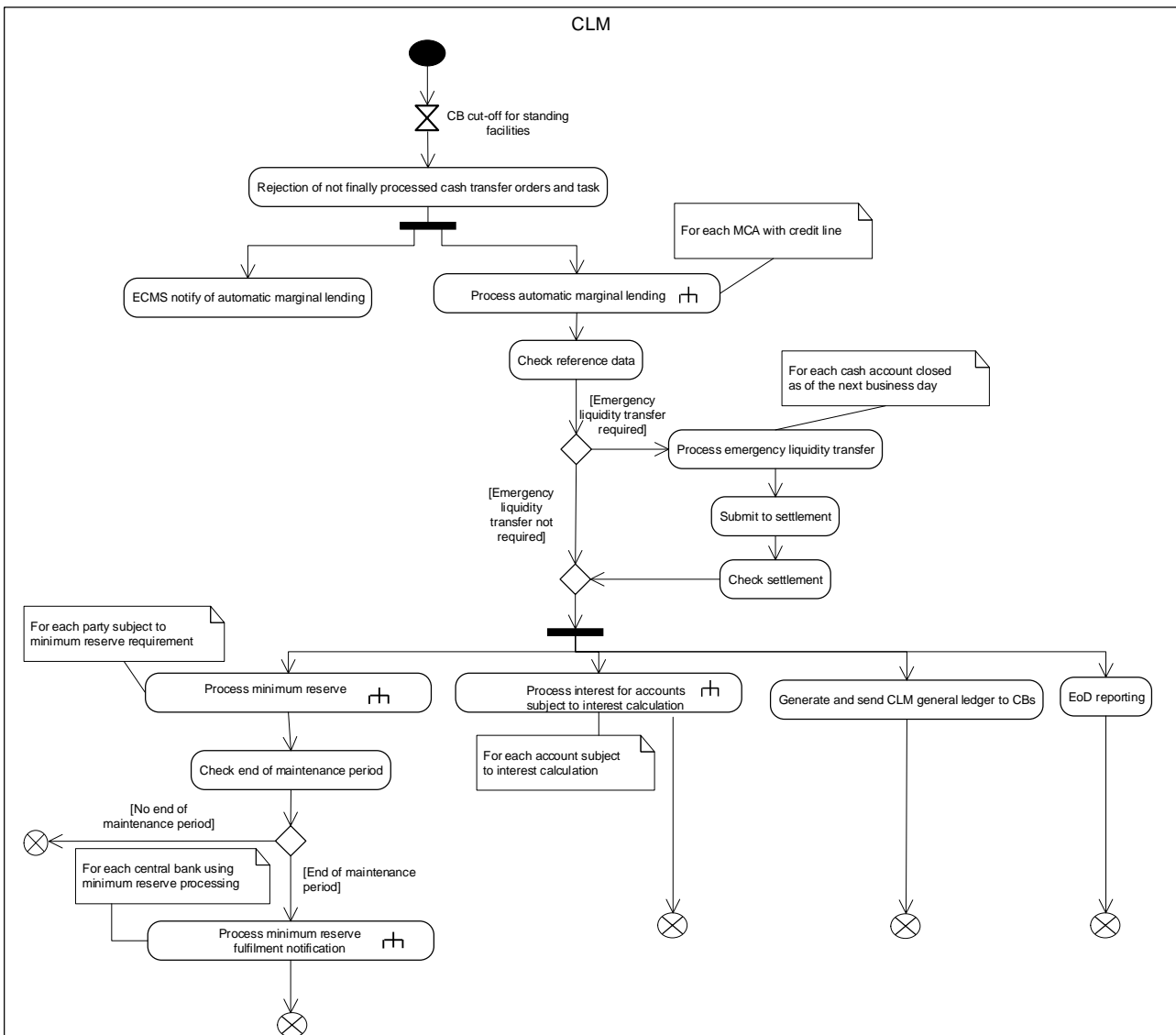

Figure 71 - Process “CB cut-off for standing facilities”

The event “CB cut-off for standing facilities” triggers the rejection of not finally processed cash transfer orders and tasks. The process continues in parallel with the process “ECMS notify of automatic marginal lending” (once ECMS is live) and the sub-process “Process automatic marginal lending”. Then the process continues with the step “Check reference data”.

Check reference data

The processing step checks if there are any cash accounts to be closed as of the next business day that have a balance.

- I In case no such accounts exist, the EoD processing continues and triggers in parallel the following sub-processes and processing steps.
 - [Process minimum reserve](#) [▶ 290] for each party subject to minimum reserve requirement.

- [Process interest for accounts subject to interest calculation](#) [▶ 260] for each account subject to interest calculation.
 - Generate and send CLM general ledger to CBs.
 - EoD reporting.
- l In case there is a cash account to be closed which has a balance and shall be closed as of the next business day, the processing continues with the processing step “Process emergency liquidity transfer”.

Check end of maintenance period

The process step checks if the minimum reserve maintenance period ends:

- l in case the current business day is not the last day of the minimum reserve maintenance period, the processing terminates;
- l in case the current business day is the last day of the minimum reserve maintenance period, the [Process minimum reserve fulfilment notification](#) [▶ 296] is called for each CB using minimum reserve processing.

Process emergency liquidity transfer

The process step creates an emergency liquidity transfer order for each cash account that has a balance, but shall be closed as of the next business day, towards the default CB Account of the CB the CLM Account Holder belongs to (see chapter [Closing of accounts still containing a balance](#) [▶ 61]). It continues with the processing step “Submit to settlement”.

Submit to settlement

This processing step submits the liquidity transfer order to the process [Perform standard CLM settlement](#) [▶ 223] and continues with the processing step “Check settlement”.

Check settlement

This processing step checks continuously whether all submitted liquidity transfer orders are settled. Once all liquidity transfer orders are settled, the processing continues and triggers in parallel the following sub-processes and processing steps.

- l [Process minimum reserve](#) [▶ 290] for each party subject to minimum reserve requirement. After successful finalisation of “Process minimum reserve” for each institution subject to minimum reserve, the processing continues with “Check end of maintenance period”.
- l [Process interest for accounts subject to interest calculation](#) [▶ 260] for each account subject to interest calculation.
- l Generate and send CLM general ledger to CBs.
- l EoD reporting.

9.23 Processing of standing facilities

9.23.1 Process overnight deposit - setting up order

The process for overnight deposit – setting up order is identical to the processing of liquidity transfers in CLM. This includes also the sending of the same notifications as for liquidity transfers (which differ depending on the submission in A2A or U2A).

In A2A the submitting actor sends a [LiquidityCreditTransfer \(camt.050\)](#) [▶ 505] for setting up an overnight deposit in CLM or RTGS. In addition, the submitting actor has the possibility to trigger an overnight deposit also via U2A. CLM checks whether the actor is allowed to use the overnight deposit facility (see [Index of validation rules and error codes](#) [▶ 643]).

The account to be debited is the MCA of the CLM Account Holder requesting the overnight deposit, an RTGS DCA, an RTGS sub-account, an RTGS CB Account or a TIPS Account. The account to be credited is an overnight deposit account and in case the liquidity comes from an MCA it must be the overnight deposit account of the CB for the respective CLM Account Holder requesting the overnight deposit.

The processing of liquidity transfer orders is described in chapters:

- I [Process CLM payment order and liquidity transfer order](#) [▶ 213];
- I [Perform standard CLM settlement](#) [▶ 223].

Further details on overnight deposit – setting up can be found in chapter [Overnight deposit](#) [▶ 145] and as regards out CBs in chapter [Specific requirements for out-CBs](#) [▶ 204].

9.23.2 Process overnight deposit - reverse order

The process for overnight deposit - reverse order to the CLM Account Holder's MCA is identical to the processing of liquidity transfers in CLM. This includes also the sending of the same notifications as for liquidity transfers (which differ depending on the submission in A2A or U2A).

In A2A, the submitting actor sends a [LiquidityCreditTransfer \(camt.050\)](#) [▶ 505] for setting up an overnight deposit reverse order in CLM. In addition, the submitting actor has the possibility to trigger an overnight deposit reverse order also via U2A.

The account to be debited is the overnight deposit account of the CB for the respective CLM Account Holder requesting the overnight deposit reverse order. The account to be credited is the MCA of the CLM Account Holder requesting the overnight deposit reverse order.

The processing of liquidity transfer orders is described in chapters:

- I [Process CLM payment order and liquidity transfer order](#) [▶ 213];
- I [Perform standard CLM settlement](#) [▶ 223].

Further details on overnight deposit - reverse order can be found in chapter [Overnight deposit](#) [▶ 145].

9.23.3 Process overnight deposit - refund and interest

This sub-process triggers the refunding of each overnight deposit use for all relevant counterparties as well as the related settlement of interest:

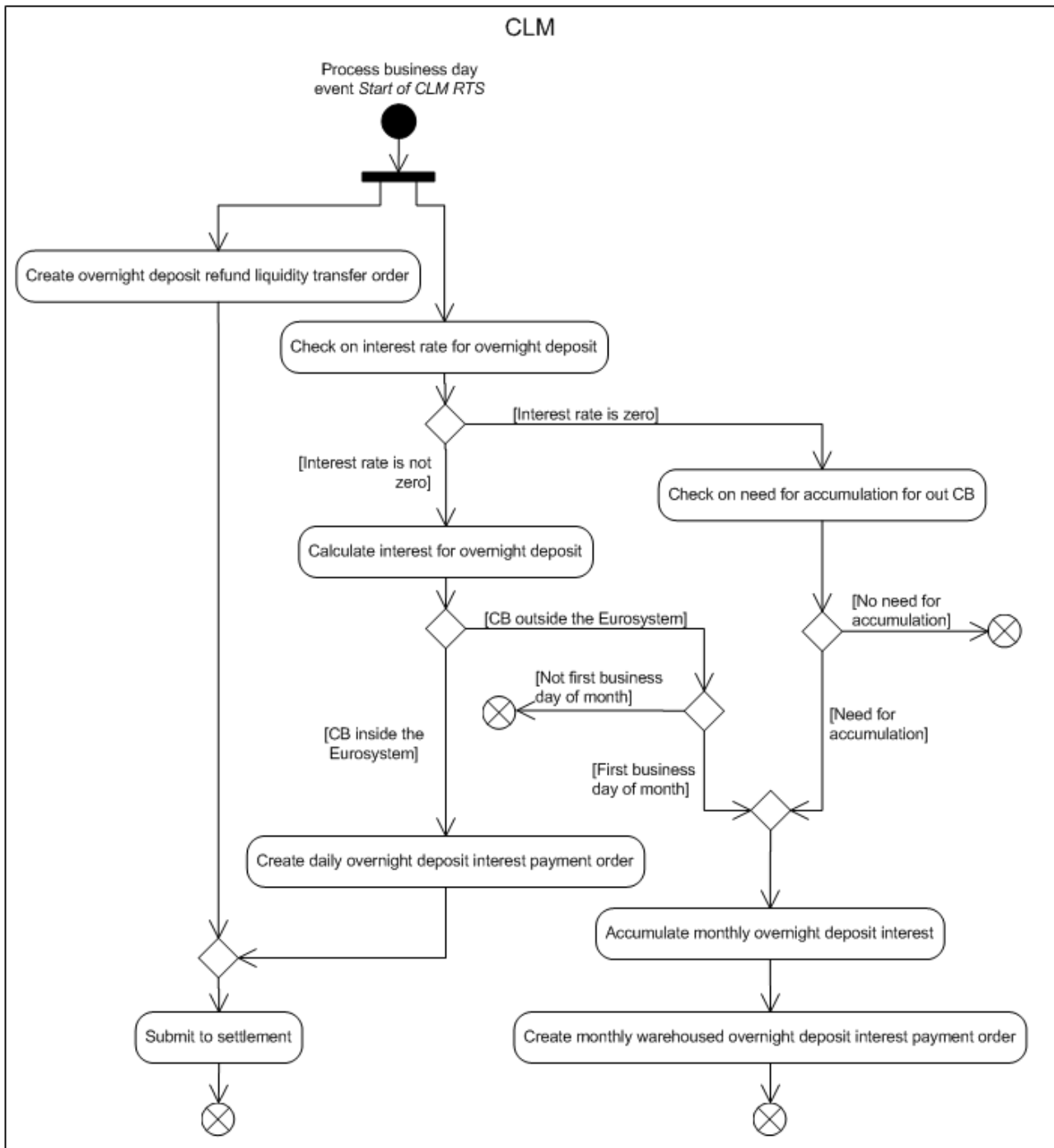

Figure 72 - Overnight deposit - refund

CLM initiates this sub-process during “Start of CLM RTS” processing.

The processing continues with a split allowing a different processing for “Create overnight deposit refund liquidity transfer order” and “Check on interest rate for overnight deposit”.

Create overnight deposit refund liquidity transfer order

The process step generates the overnight deposit refund liquidity transfer order and the process continues with “Submit to settlement”.

Check on interest rate for overnight deposit

The process step checks the interest rate for overnight deposit:

- | in case the interest rate is unequal to zero, the processing continues with “Calculate interest for overnight deposit”;
- | in case the interest rate is equal to zero, the processing continues with “Check on need for accumulation for out CB”.

Check on need for accumulation for out CB

The process step checks if:

- | the relevant CB is an out CB;
- | the current business day is the first business day of the month;
- | interest on overnight deposit was calculated on at least one business day of the previous month.

Depending on the result, the following cases occur:

- | in case all mentioned conditions are fulfilled, the processing continues with “Accumulate monthly overnight deposit interest”;
- | in case at least one of the mentioned conditions is not fulfilled, the processing terminates.

Calculate interest for overnight deposit

The process step calculates the daily overnight deposit interest and the process continues:

- | for CLM Account Holder with responsible CB inside the Eurosystem with “Create daily overnight deposit interest payment order”;
- | for CLM Account Holder with responsible CB outside the Eurosystem depending on the business day:
 - in case the business day is the first business day of the month, the processing continues with “Accumulate monthly overnight deposit interest”;
 - in case the business day is not the first business day of the month, the processing terminates.

Create daily overnight deposit interest payment order

This processing step generates on each business day the overnight deposit interest payment order and the process continues with “Submit to settlement”.

Accumulate monthly overnight deposit interest

This processing step accumulates the calculated daily interest for the last calendar month and the process continues with “Create monthly warehoused overnight deposit interest payment order”.

Create monthly warehoused overnight deposit interest payment order

This processing step generates the overnight deposit interest payment order on the first business day of the following month with value date five business days after the generation date (warehoused payment). Their further processing is described in chapter [Process business day event “Change of business day”](#) [▶ 267].

Submit to settlement

The settlement process for the refund of overnight deposits is identical to the settlement process of liquidity transfers in CLM.

The settlement process for overnight deposit interest payment orders is identical to the settlement process of payments in CLM. In case of positive interest, a credit transfer order is created. In case of negative interest, a debit transfer order is created.

This processing step submits the liquidity transfer orders and payment orders to the process [Perform standard CLM settlement](#) [▶ 223].

9.23.4 Process marginal lending on request - setting up order

9.23.4.1 Before launch of ECMS

Before the launch of ECMS, the process for marginal lending on request – setting-up order is identical to the processing of liquidity transfers in CLM. This includes also the sending of the same notifications as for liquidity transfers (which differ depending on the submission in A2A or U2A).

In A2A the local CMS of the CB sends a [LiquidityCreditTransfer \(camt.050\)](#) [▶ 505] for setting-up a marginal lending on request to CLM. In addition, CBs have the possibility to trigger marginal lending on request also via U2A.

The debit account for the setting-up order is the marginal lending account of the CB dedicated to the respective CLM Account Holder in CLM. The credit account is the MCA of the CLM Account Holder requesting the marginal lending.

The processing of liquidity transfer orders is described in chapters:

- I [Process CLM payment order and liquidity transfer order](#) [▶ 213];
- I [Perform standard CLM settlement](#) [▶ 223].

Further details on marginal lending on request can be found in chapter [Marginal lending on request](#) [▶ 146].

9.23.4.2 After launch of ECMS

After the launch of ECMS, the process for marginal lending on request – setting-up order is identical to the processing of payment orders in CLM. This includes also the sending of the same notifications as for payment orders.

In A2A ECMS sends a [FinancialInstitutionCreditTransfer \(pacs.009\)](#) [▶ 624] for setting-up a marginal lending on request to CLM. In addition, CBs have the possibility to trigger marginal lending on request also via U2A in the ECMS.

The debit account for the setting-up order is the relevant account of the CB in CLM. The credit account is an MCA defined by the CLM Account Holder requesting the marginal lending.

The processing of payment orders is described in chapters:

- I [Process CLM payment order and liquidity transfer order](#) [▶ 213];
- I [Perform standard CLM settlement](#) [▶ 223].

9.23.5 Process marginal lending on request - reverse order

9.23.5.1 Before launch of ECMS

The process is only available in U2A for the operator on behalf of the CB. The process for marginal lending on request – reverse order is identical to the processing of liquidity transfers in CLM. This includes also the sending of the same notifications as for liquidity transfers initiated via U2A.

The debit account is an MCA defined by the CLM Account Holder. The credit account is the marginal lending account which served as basis for the marginal lending on request – setting up.

The processing of liquidity transfer orders is described in chapters:

- I [Process CLM payment order and liquidity transfer order](#) [▶ 213];
- I [Perform standard CLM settlement](#) [▶ 223].

Further details on marginal lending on request can be found in chapter [Marginal lending on request](#) [▶ 146].

9.23.5.2 After launch of ECMS

The process for marginal lending on request – reverse order is identical to the processing of payment orders in CLM.

The debit account is an MCA defined by the CLM Account Holder. The credit account is the relevant account of the CB in CLM.

The processing of payment orders is described in chapters:

- I [Process CLM payment order and liquidity transfer order](#) [▶ 213];
- I [Perform standard CLM settlement](#) [▶ 223].

9.23.6 Process automatic marginal lending - setting up - before and after launch of ECMS

9.23.6.1 Description

This sub-process triggers the execution of automatic marginal lending for all relevant counterparties. It applies before and after the launch of ECMS with one exception.

After the launch of ECMS ECMS is informed on the automatic marginal lending:

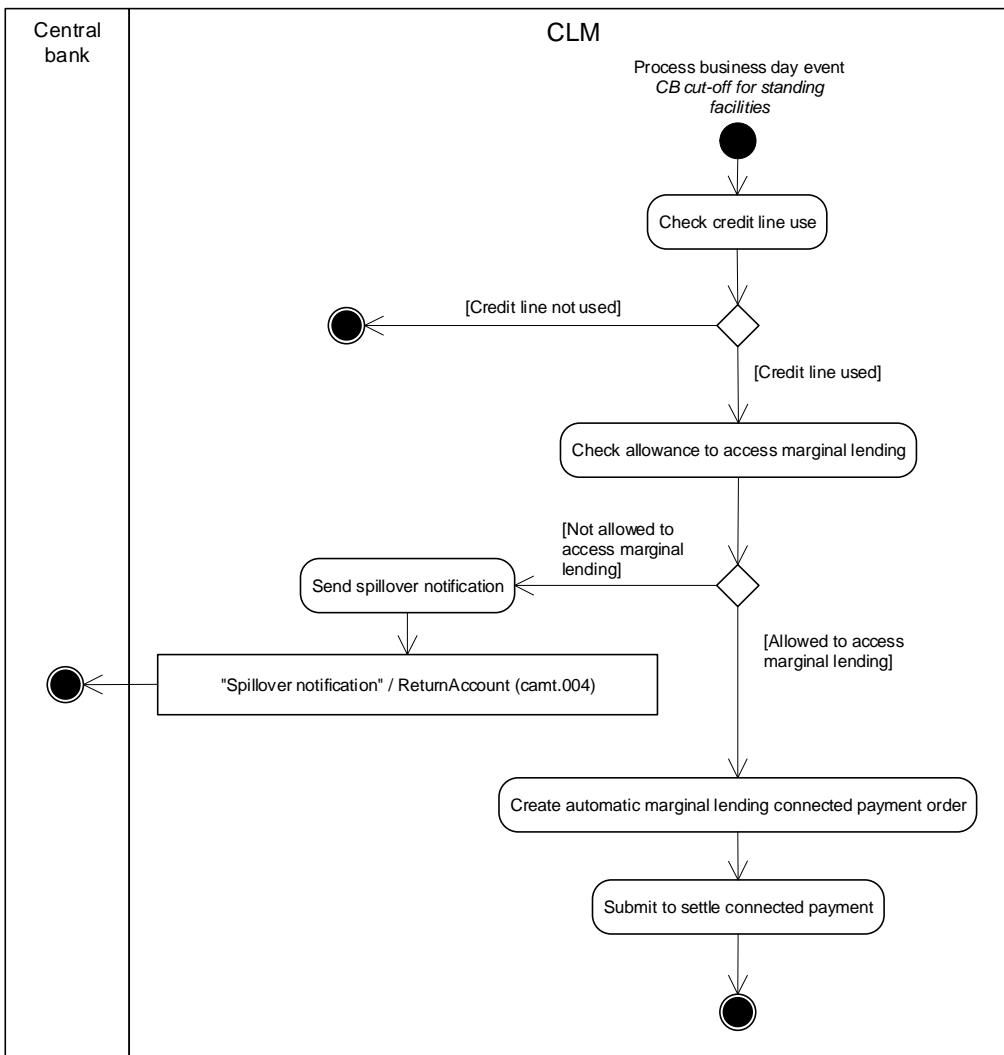

Figure 73 - Process automatic marginal lending – setting up

CLM initiates this sub-process during [“CB cut-off for standing facilities”](#) [▶ 272] processing.

The processing continues with the process step “Check credit line use”.

Further details on automatic marginal lending can be found in chapter [Automatic marginal lending](#) [▶ 149].

Check credit line use

The process step checks if an existing credit line is used (fully or partially) by the CLM Account Holder. The check takes the data on relevant balances received from all settlement services into account. The automatic marginal lending is used to transform an intraday credit into an overnight credit at the end of the business day. In case no credit line is used, the processing terminates. If the calculated overall aggregated balance of the institution on all of the cash accounts to be included in the calculation is negative, the processing continues with “Check allowance to access marginal lending”. Further details are provided in chapter [Automatic marginal lending](#) [▶ 149].

Check allowance to access marginal lending

The process step checks if the CLM Account Holder is allowed to access marginal lending. In case the CLM Account Holder is not allowed to access marginal lending, the processing continues with “Send spillover notification”. In case the CLM Account Holder is allowed to access marginal lending (i.e. marginal lending account is available for the CLM Account Holder), the processing continues with “Create automatic marginal lending connected payment order”.

Send spillover notification

This processing step sends the "Spillover notification"/[ReturnAccount \(camt.004\)](#) [▶ 380] to the CB responsible for the CLM Account Holder.

Create automatic marginal lending connected payment order

The process step generates the automatic marginal lending connected payment order and the process continues with “Submit to settle connected payment”.

Submit to settle connected payment

This processing step submits the automatic marginal lending connected payment order to the process “[Settle connected payments](#) [▶ 243]”.

9.23.6.2 Messages

Report name	ISO message	ISO code
Spillover notification	ReturnAccount [▶ 380]	camt.004 [▶ 380]

Table 80 - Outbound messages for process automatic marginal lending

9.23.7 Process marginal lending - reimbursement and interest

This sub-process triggers the reimbursement of all marginal lending uses for all relevant counterparties as well as the related settlement of interest.

Further details on marginal lending can be found in chapters [Marginal lending on request](#) [▶ 146] and [Automatic marginal lending](#) [▶ 149].

9.23.7.1 Before launch of ECMS

Before the launch of ECMS, CLM starts this process based on the business day event “Start of CLM RTS”.

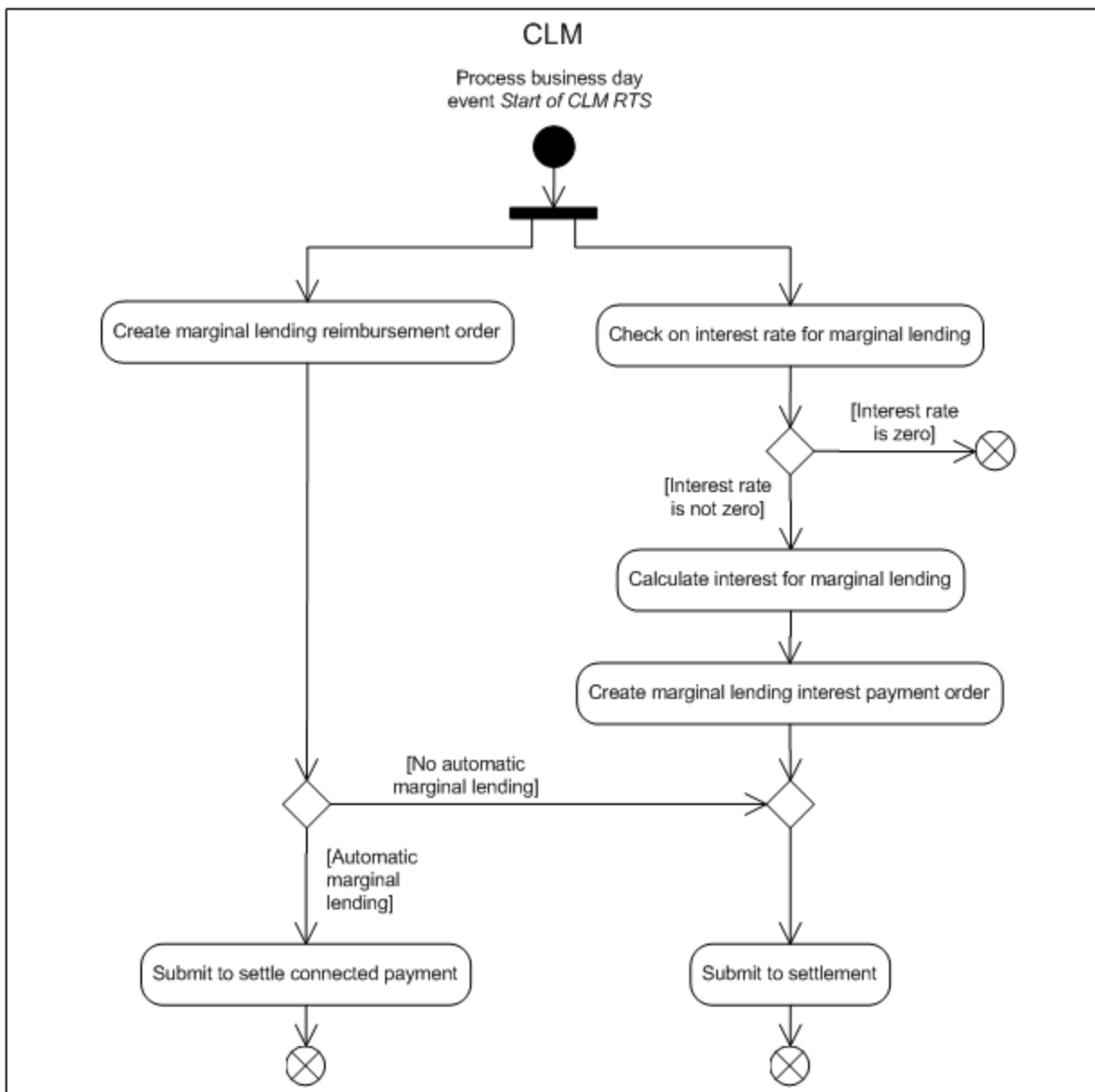

Figure 74 - Reimburse marginal lending

The processing continues with a split into the following processing steps:

- I “Create marginal lending reimbursement order” and
- I “Check on interest rate for marginal lending”

Create marginal lending reimbursement order

The process step generates the marginal lending reimbursement order. The debit account for the reimbursement order is an MCA defined by the CB for the CLM Account Holder accessing the marginal lending. The credit account is the relevant dedicated marginal lending account in CLM.

In case the underlying business case was an automatic marginal lending, the marginal lending reimbursement order is a connected payment and the processing continues with “Submit to settle connected payment”.

In case the underlying business case was a marginal lending on request, the marginal lending reimbursement order is a liquidity transfer and the processing continues with “Submit to settlement”.

Submit to settlement

The settlement process for marginal lending on request reimbursement is identical to the settlement process of liquidity transfers in CLM.

The processing step submits the liquidity transfer orders to the process [Perform standard CLM settlement](#) [▶ 223].

Submit to settle connected payments

This processing step submits the connected payment order to reimburse the automatic marginal lending to the process [Settle connected payments](#) [▶ 243].

Check on interest rate for marginal lending

The process step checks the interest rate for marginal lending:

- | in case the interest rate is not equal to zero, the processing continues with “Calculate interest for marginal lending”;
- | in case the interest rate is equal to zero, the processing terminates.

Calculate interest for marginal lending

The process step first checks if the marginal lending has to be excluded from the interest calculation or not (information is stored in the reference data) and calculates as follows:

- | in case the marginal lending does not have to be excluded from the interest calculation, the interest to be paid is calculated based on the total amount on the respective marginal lending account;
- | in case the marginal lending has to be excluded from the interest calculation, the interest to be paid is calculated based on the amount on the respective marginal lending account related to the marginal lending only.

The process continues with “Create marginal lending interest payment order”.

Create marginal lending interest payment order

The process step generates the marginal lending interest payment order and the process continues with “Submit to settlement”. In case of both a marginal lending on request and an automatic marginal lending of a

single CLM Account Holder eligible for marginal lending only one interest payment is generated covering both types of marginal lending.

9.23.7.2 After launch of ECMS

After the launch of ECMS, this process triggers the reimbursement of automatic marginal lending for all relevant counterparties in accordance with the processing [Before launch of ECMS](#) [▶ 282].

For reimbursement of marginal lending on request the following rule applies: As ECMS can send regular or connected payment orders, CLM processes the payment orders received from ECMS in accordance with the relevant sub-process, which is either “Perform standard CLM settlement” or “Settle connected payment”. This includes reimbursement of marginal lending on request and respective interest payment orders.

9.24 Processing of minimum reserve and interest

9.24.1 Maintain minimum reserve requirement order

9.24.1.1 Description

This process allows a CB to insert the value of the minimum reserve requirement for each counterparty subject to minimum reserve.

Further details can be found in chapter [Minimum reserve management and interest calculation](#) [▶ 139].

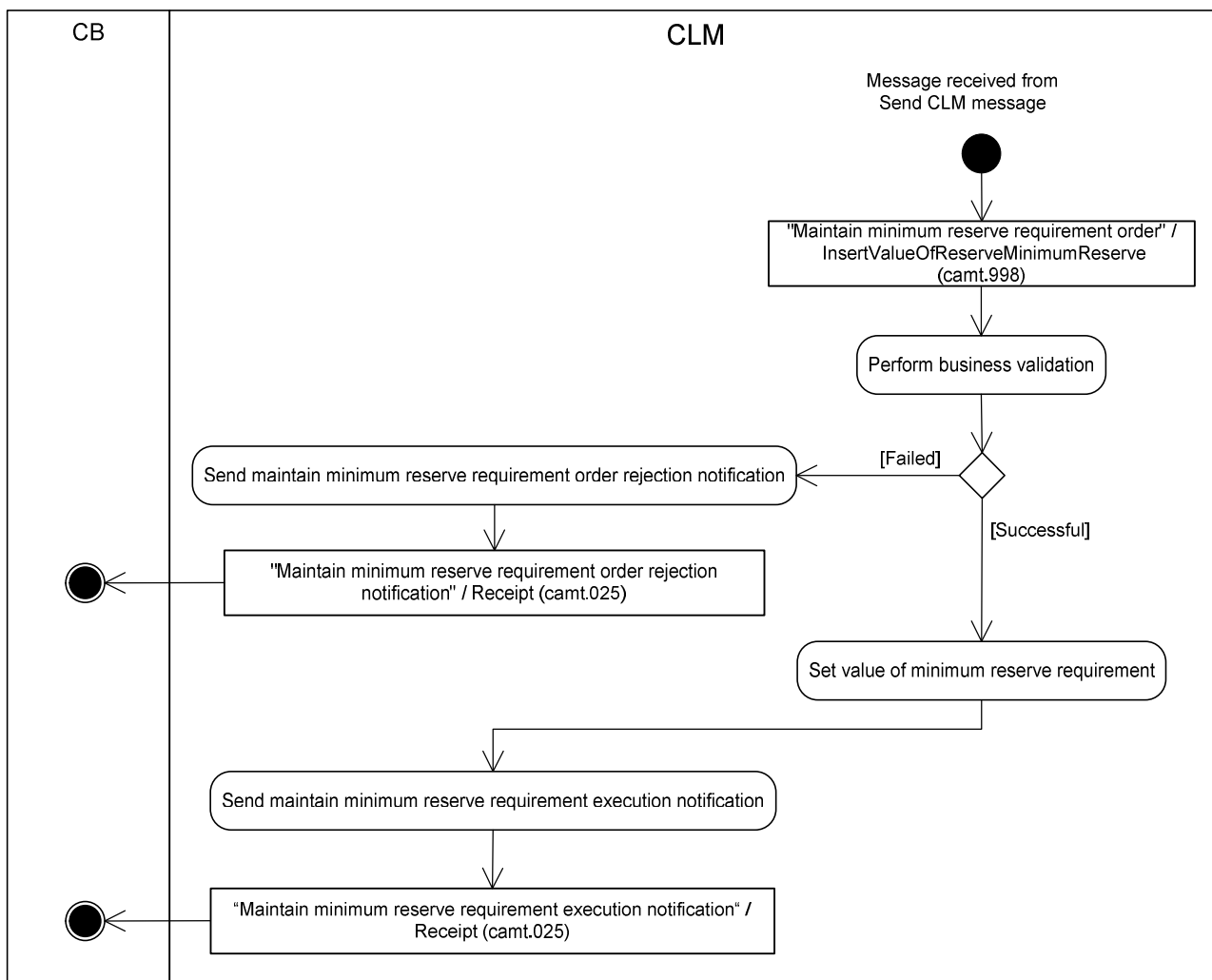

Figure 75 - Maintain minimum reserve requirement order

CLM initiates this process when it receives a message from the process “Send CLM message” to insert a value for minimum reserve requirement.

The initial set-up and the modification of the value of the minimum reserve requirement are identical, i.e. in every message an absolute value is provided, no delta value is allowed.

The processing continues with the process step “Perform business validations”.

Perform business validations

The process step verifies whether the “Maintain minimum reserve requirement order” is compliant with the business validation rules. It performs the business validations to the extent possible in order to report the maximum number of validation errors to the submitting CB.

- I **[Failed]** The minimum reserve requirement maintenance order is not compliant with the business validation rules. The processing continues with “Send maintain minimum reserve requirement order rejection notification”.

- I **[Successful]** The minimum reserve fulfilment maintenance order complies with the business validation rules. The processing continues with “Set value of minimum reserve requirement”.

Send maintain minimum reserve requirement order rejection notification

CLM rejects the request and sends a “Maintain minimum reserve requirement order rejection notification”/[Receipt \(camt.025\)](#) [▶ 479] to the submitting CB.

Set value of minimum reserve requirement

The process step executes the minimum reserve requirement maintenance order and the processing continues with “Send maintain minimum reserve requirement execution notification”

Send maintain minimum reserve requirement execution notification

CLM sends a “Maintain minimum reserve requirement execution notification”/[Receipt \(camt.025\)](#) [▶ 479] to the submitting CB.

9.24.1.2 Messages

Message description/usage	ISO message	ISO code
Maintain minimum reserve requirement order	InsertValueOfReserveMinimumReserve [▶ 600]	camt.998 [▶ 600]

Table 81 - Inbound messages for maintain minimum reserve requirement

Message description/usage	ISO message	ISO code
Maintain minimum reserve requirement order rejection notification	Receipt [▶ 479]	camt.025 [▶ 479]
Maintain minimum reserve requirement execution notification	Receipt [▶ 479]	camt.025 [▶ 479]

Table 82 - Outbound messages for maintain minimum reserve requirement

9.24.2 Insert or adjust balance for minimum reserve fulfilment

9.24.2.1 Description

This process allows a CB to insert additional balances of accounts outside TARGET Services for the minimum reserve fulfilment for any counterparty that is subject to minimum reserve in CLM. In addition, it is

possible to adjust EoD balances to be considered for the fulfilment of the minimum reserve requirement of an institution.

Further details can be found in chapter [Minimum reserve management and interest calculation](#) [▶ 139].

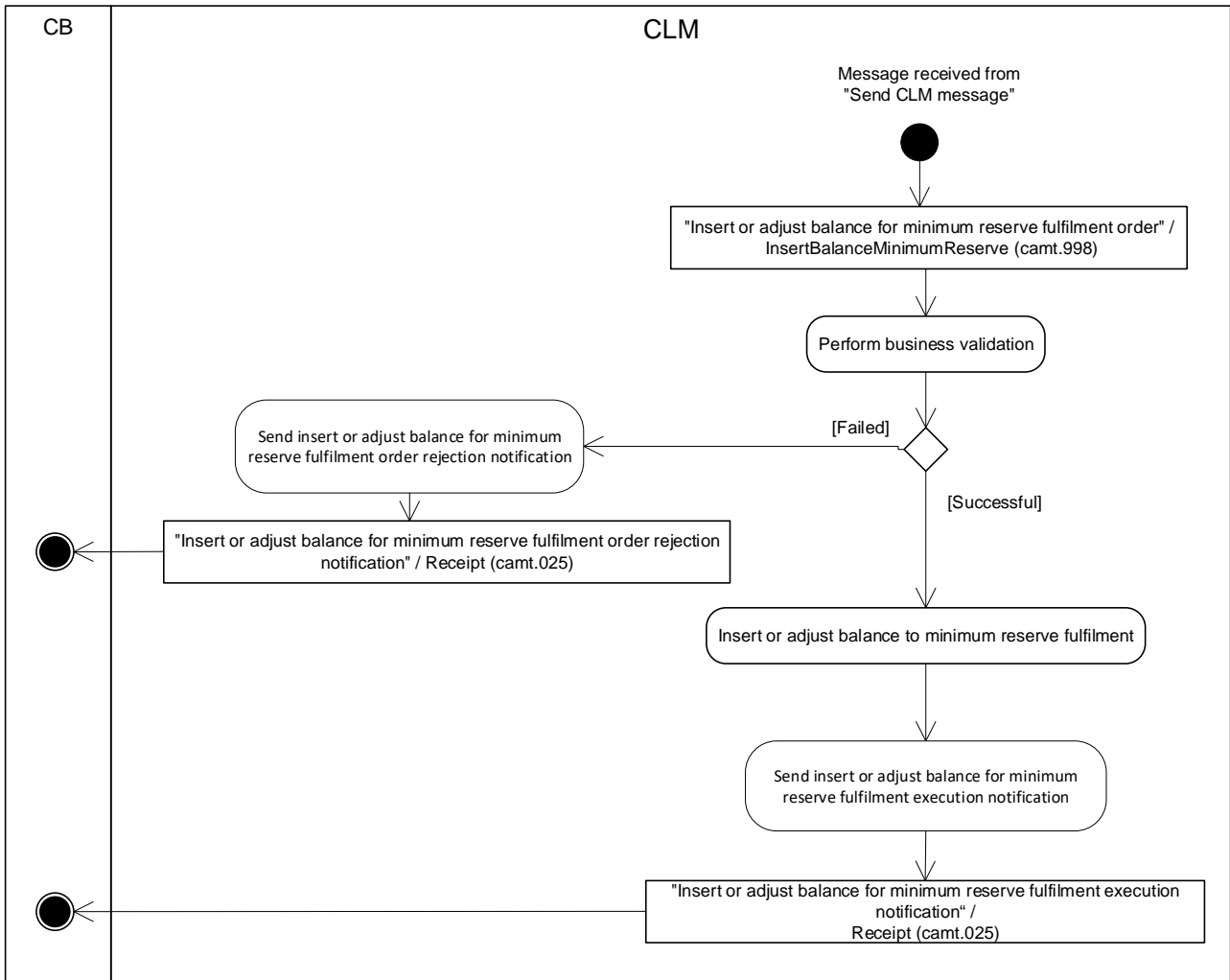

Figure 76 - Insert or adjust balance for minimum reserve fulfillment

CLM initiates this process when it receives a message from the process “Send CLM message” to insert additional balances of accounts outside TARGET Services or to adjust the balance for the minimum reserve fulfillment.

The processing continues with the process step “Perform business validations”.

Perform business validations

The process step verifies whether the “Insert or adjust balance for minimum reserve fulfillment order” is compliant with the business validation rules. It performs the business validations to the extent possible in order to report as many as possible validation errors to the submitting CB.

- I **[Failed]** The insert balance for minimum reserve fulfilment order is not compliant with the business validation rules. The processing continues with the step “Send insert or adjust balance for minimum reserve fulfilment order rejection notification”.
- I **[Successful]** The insert balance for minimum reserve fulfilment order complies with the business validation rules. The processing continues with the step “Insert or adjust balance to minimum reserve fulfilment”.

Send insert or adjust balance for minimum reserve fulfilment order rejection notification

CLM rejects the request and sends an “Insert or adjust balance for minimum reserve fulfilment order rejection notification”/[Receipt \(camt.025\)](#) [▶ 479] to the submitting CB.

Insert or adjust balance to minimum reserve fulfilment

The process step executes the insert or adjust balance for minimum reserve fulfilment order and the processing continues with “Send insert balance for minimum reserve fulfilment execution notification”.

Send insert or adjust balance for minimum reserve fulfilment execution notification

CLM sends an "Insert or adjust balance for minimum reserve fulfilment execution notification”/[Receipt \(camt.025\)](#) [▶ 479] to the submitting CB.

9.24.2.2 Messages

Message description/usage	ISO message	ISO code
Insert or adjust balance for minimum reserve fulfilment order	InsertBalanceMinimumReserve (camt.998) - specific for CBs [▶ 604]	camt.998 [▶ 604]

Table 83 - Inbound messages for insert or adjust balance for minimum reserve fulfilment

Message description/usage	ISO message	ISO code
Insert or adjust balance for minimum reserve fulfilment order rejection notification	Receipt (camt.025) [▶ 479]	camt.025 [▶ 479]
Insert or adjust balance for minimum reserve fulfilment execution notification	Receipt (camt.025) [▶ 479]	camt.025 [▶ 479]

Table 84 - Outbound messages for insert or adjust balance for minimum reserve fulfilment

9.24.3 Process minimum reserve

This sub-process triggers the minimum reserve fulfilment calculation, respective interest and penalties for all parties subject to minimum reserve requirement.

Further details on minimum reserve can be found in chapter [Minimum reserve management and interest calculation](#) [▶ 139].

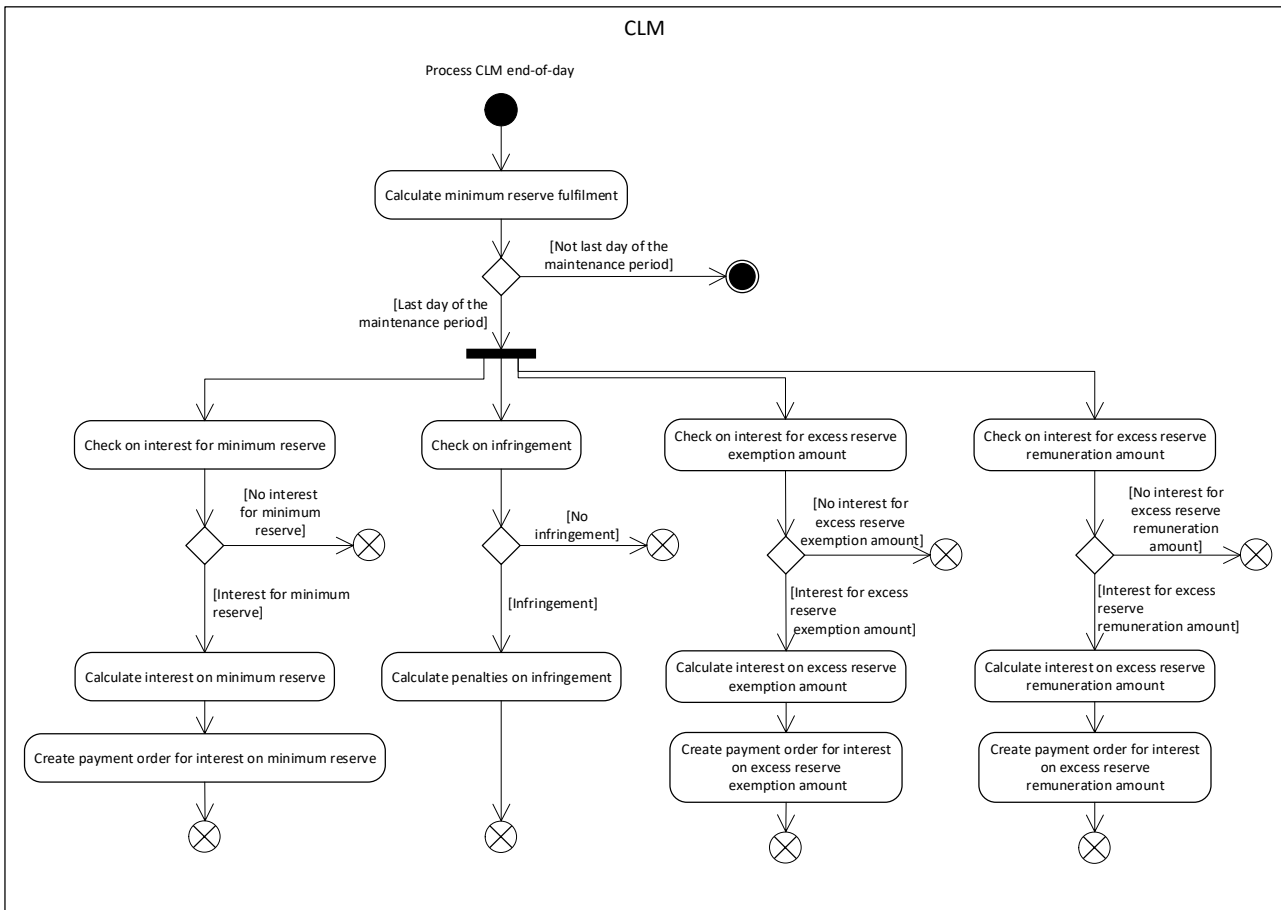

Figure 77 - Process minimum reserve

CLM initiates this sub-process during [“CB cut-off for standing facilities”](#) [▶ 272] processing.

The processing continues with [“Calculate minimum reserve fulfilment”](#).

Calculate minimum reserve fulfilment

On a daily basis, this processing step calculates the accumulation of EoD balances of all relevant cash accounts, the running average and the adjustment balance for all parties subject to minimum reserve requirements. In addition, this calculation may include also balances on accounts held outside the TARGET Services, which are to be considered according to the [InsertBalanceMinimumReserve](#) [▶ 604] message sent by the responsible CB.

- | In case it is the last business day of minimum reserve maintenance period, the processing continues with a split allowing a different processing for “Check on interest for minimum reserve”, “Check on infringement”, “Check on interest for excess reserve exemption amount” and “Check on interest for excess reserve remuneration amount”.
- | In case it is not the last business day of minimum reserve maintenance period, the processing terminates.

Check on interest for minimum reserve

This processing step checks if interest has to be calculated for the minimum reserve.

Interest has to be calculated if all following conditions are fulfilled:

- | the interest rate to be considered is not equal to zero;
- | the minimum reserve requirement is not equal to zero;
- | the running average to be considered is not equal to zero.

The processing continues as follows:

- | in case no interest for minimum reserve has to be calculated, the processing terminates;
- | in case interest for minimum reserve has to be calculated, the processing continues with “Calculate interest on minimum reserve”.

Check on infringement

This processing step checks if the minimum reserve requirements are violated (i.e. infringement of the minimum reserve requirements):

- | in case of no infringement of the minimum reserve requirements, the processing terminates;
- | in case of infringement of the minimum reserve requirements, the processing continues with “Calculate penalties on infringement”.

Check on interest for excess reserve - exemption amount

This processing step checks if interest have to be calculated:

Interest has to be calculated if all following conditions are fulfilled:

- | the excess reserve interest rate (exempt tier) to be considered is not equal to zero;
- | the excess reserve is not equal to zero.

The processing continues as follows:

- | in case no interest for the exempt tier of the excess reserve has to be calculated, the processing terminates;
- | in case interest for excess reserve has to be calculated, the processing continues with “Calculate interest on excess reserve – exemption amount”.

Check on interest for excess reserve – remuneration amount

This processing step checks if interest have to be calculated:

Interest has to be calculated if all following conditions are fulfilled:

- | the excess reserve interest rate (non-exempt tier) to be considered is not equal to zero;
- | the excess reserve is not equal to zero.

The processing continues as follows:

- | in case no interest for the non-exempt tier of the excess reserve has to be calculated, the processing terminates;
- | in case interest for excess reserve has to be calculated, the processing continues with “Calculate interest on excess reserve – remuneration amount”.

Calculate interest on minimum reserve

This processing step calculates the interest on the minimum reserve and the processing continues with “Create payment order for interest on minimum reserve”.

Calculate penalties on infringement

This processing step calculates the penalties due to the infringement of the minimum reserve requirements and the processing terminates. The further processing of the infringements of the minimum reserve requirements is described in [Administrate minimum reserve penalty order](#) [▶ 293].

Calculate interest on excess reserve – exemption amount

This processing step calculates the interest to be paid on the exempt tier of the excess reserve and the processing continues with “Create payment order for interest on excess reserve – exemption amount”.

Calculate interest on excess reserve – remuneration amount

This processing step calculates the interest to be paid on the non-exempt tier of the excess reserve and the processing continues with “Create payment order for interest on excess reserve – remuneration amount”.

Create payment order for interest on minimum reserve

This processing step creates the payment order for interest on minimum reserve with value date two business days after the end of the respective minimum reserve maintenance period and with status “warehoused”. The further processing is described in [Perform standard CLM settlement](#) [▶ 223].

Create payment order for interest on excess reserve – exemption amount

This processing step creates the payment order for interest on the exempt tier of the excess reserve with value date two business days after the end of the respective maintenance period and with status “warehoused”. The further processing is described in [Perform standard CLM settlement](#) [▶ 223].

Create payment order for interest on excess reserve – remuneration amount

This processing step creates the payment order for interest on the non-exempt tier of the excess reserve with value date two business days after the end of the respective maintenance period and with status “warehoused”. The further processing is described in [Perform standard CLM settlement](#) [▶ 223].

9.24.4 Administrative minimum reserve penalty order

9.24.4.1 Description

This process allows a CB to:

- | authorise for single infringement (penalty type 1);
- | authorise for repeated infringement (penalty type 2);
- | cancel.

Penalties due to minimum reserve requirement infringement(s) for each counterparty subject to minimum reserve in CLM:

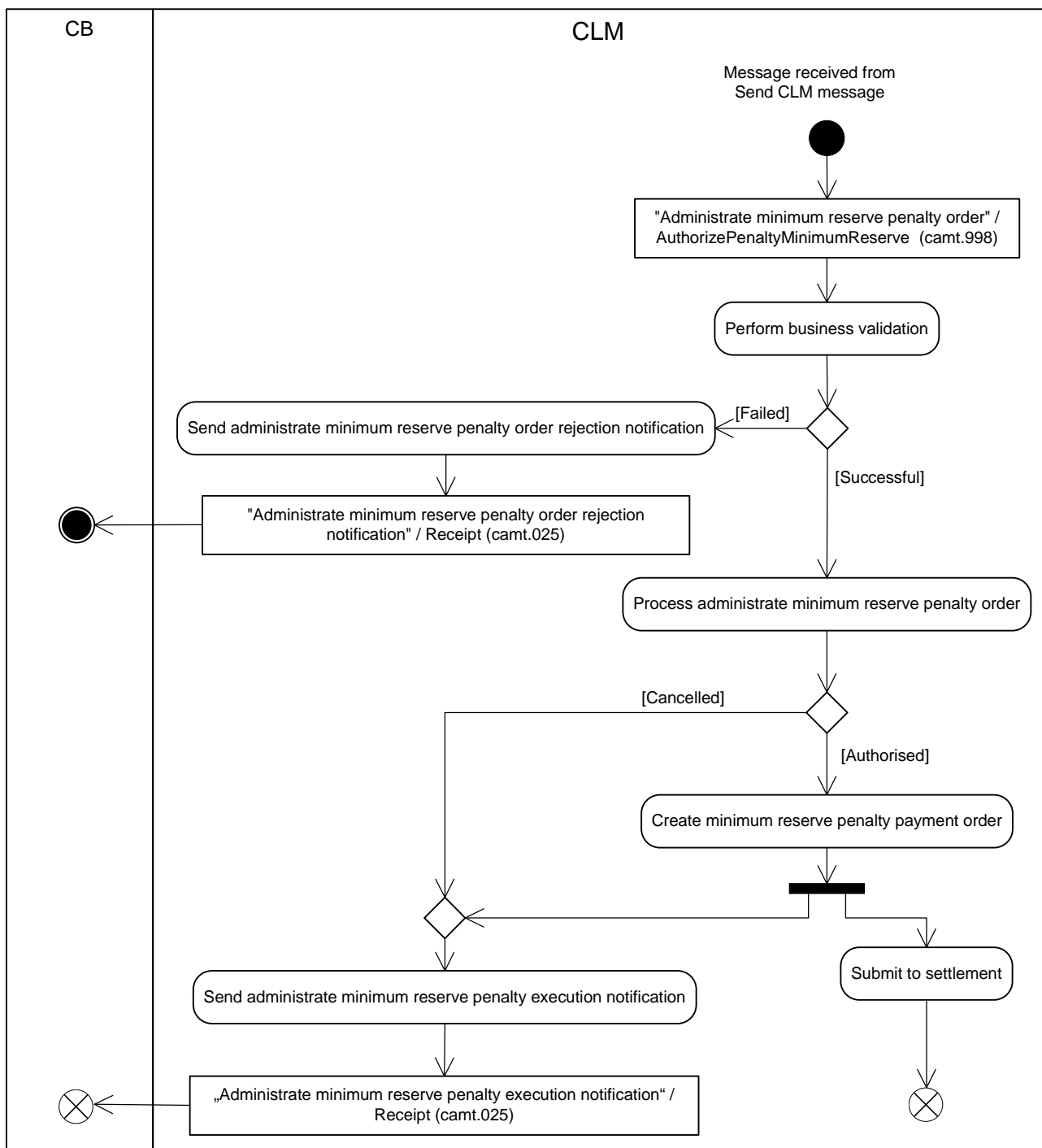

Figure 78 - Administrate minimum reserve penalty order

CLM initiates this process when it receives a message from the process “[Send CLM message](#) [▶ 211]” to administrate a minimum reserve penalty.

The processing continues with the process step “Perform business validation”.

Perform business validations

The process step verifies whether the “Administrative minimum reserve penalty order” is compliant with the business validation rules. It performs the business validations to the extent possible in order to report the maximum number of validation errors to the CB.

- | **[Failed]** The “Administrative minimum reserve penalty order” is not compliant with the business validation rules. The processing continues with “Send administrative minimum reserve penalty order rejection notification”.
- | **[Successful]** The “Administrative minimum reserve penalty order” complies with the business validation rules. The processing continues with “Process administrative minimum reserve penalty order”.

Send administrative minimum reserve penalty order rejection notification

CLM rejects the request and sends an "Administrative minimum reserve penalty order rejection notification"/[Receipt \(camt.025\)](#) [▶ 479] to the CB.

Process administrative minimum reserve penalty order

The process step executes the “Administrative minimum reserve penalty order”. In case of:

- | authorisation with determination of penalty type 1, the order is set to “authorised with penalty type 1”;
- | authorisation with determination of penalty type 2, the order is set to “authorised with penalty type 2”.

and the processing continues with “Create minimum reserve penalty payment order”.

In case of cancellation, the order is set to “cancelled” the processing continues with “Send administrative minimum reserve penalty execution notification”

Create minimum reserve penalty payment order

The process step generates the minimum reserve penalty payment order and the process executes the following two processing steps in parallel:

- | “Submit to settlement”;
- | “Send administrative minimum reserve penalty execution notification”.

Submit to settlement

This processing step submits the penalty payment order to the process “[Perform standard CLM settlement](#) [▶ 223]”.

Send administrative minimum reserve penalty execution notification

CLM sends an "Administrative minimum reserve penalty execution notification"/[Receipt \(camt.025\)](#) [▶ 479] to the CB.

9.24.4.2 Messages

Message description/usage	ISO message	ISO code
Administrate minimum reserve penalty order	AuthorizePenaltyMinimumReserve [▶ 584]	camt.998 [▶ 584]

Table 85 - Inbound messages for administrate minimum reserve penalty order

Message description/usage	ISO message	ISO code
Administrate minimum reserve penalty order rejection notification	Receipt [▶ 479]	camt.025 [▶ 479]
Administrate minimum reserve penalty order execution notification	Receipt [▶ 479]	camt.025 [▶ 479]

Table 86 - Outbound messages for administrate minimum reserve penalty order

9.24.5 Process minimum reserve fulfilment notification

9.24.5.1 Description

This sub-process triggers the minimum reserve fulfilment notification for all CBs using minimum reserve processing:

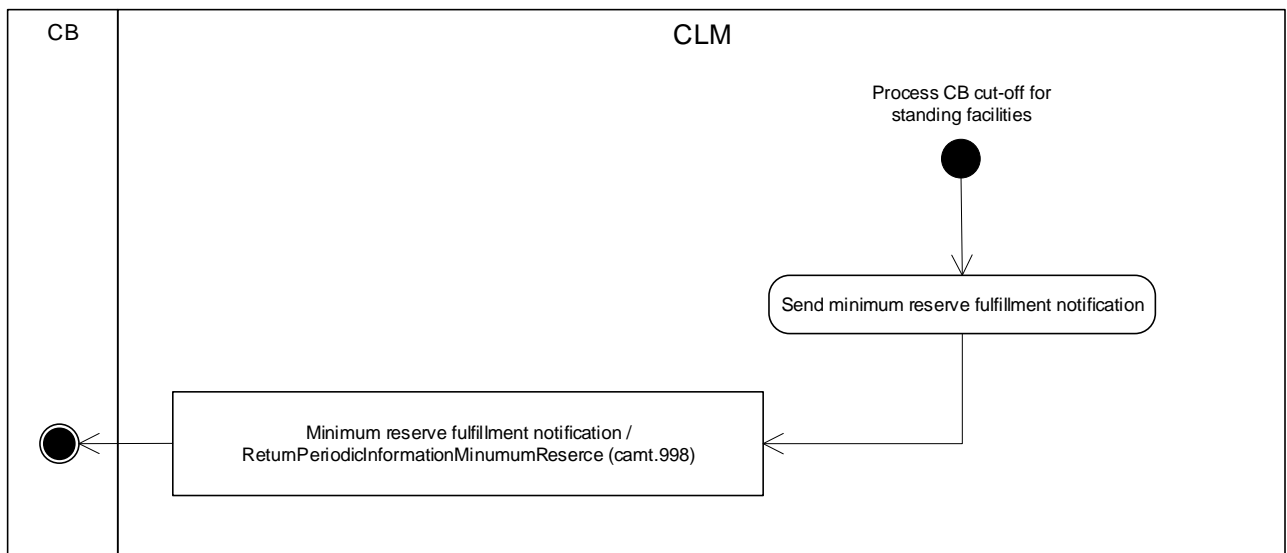

Figure 79 - Process minimum reserve fulfilment notification

CLM initiates this process during “CB cut-off for standing facilities” processing at end of minimum reserve maintenance period and after “[Process minimum reserve](#) [▶ 290]”.

The processing continues with “Send minimum reserve fulfilment notification”.

Send minimum reserve fulfilment notification

CLM sends an "Minimum reserve fulfilment notification"/[ReturnPeriodicInformationMinimumReserve \(camt.998\) - specific for CBs](#) [▶ 608] to the responsible CB.

9.24.5.2 Messages

Message description/usage	ISO message	ISO code
Minimum reserve fulfilment notification	ReturnPeriodicInformationMiniumReserve [▶ 608]	camt.998 [▶ 608]

Table 87 - Outbound message for process minimum reserve fulfilment notification

9.25 Information services

9.25.1 Send CLM query

9.25.1.1 Description

CLM provides a defined set of queries allowing the CLM Actors to request their respective business data from CLM. A query allows the CLM Actor to specify the criteria which CLM shall use to retrieve data. It allows the CLM Actor to limit the scope of the retrieved data to the specific data that the CLM Actor requires. Query requests and the query responses are ISO 20022 compliant XML messages.

The "Send CLM query" describes the interactions between a CLM Actor that submits a query and CLM that provide a response to the query. The chapter [Query management for CLM](#) [▶ 164] describes the respective business scope. The chapter [Query management - CB specific queries](#) [▶ 200] provides information on CB-specific queries:

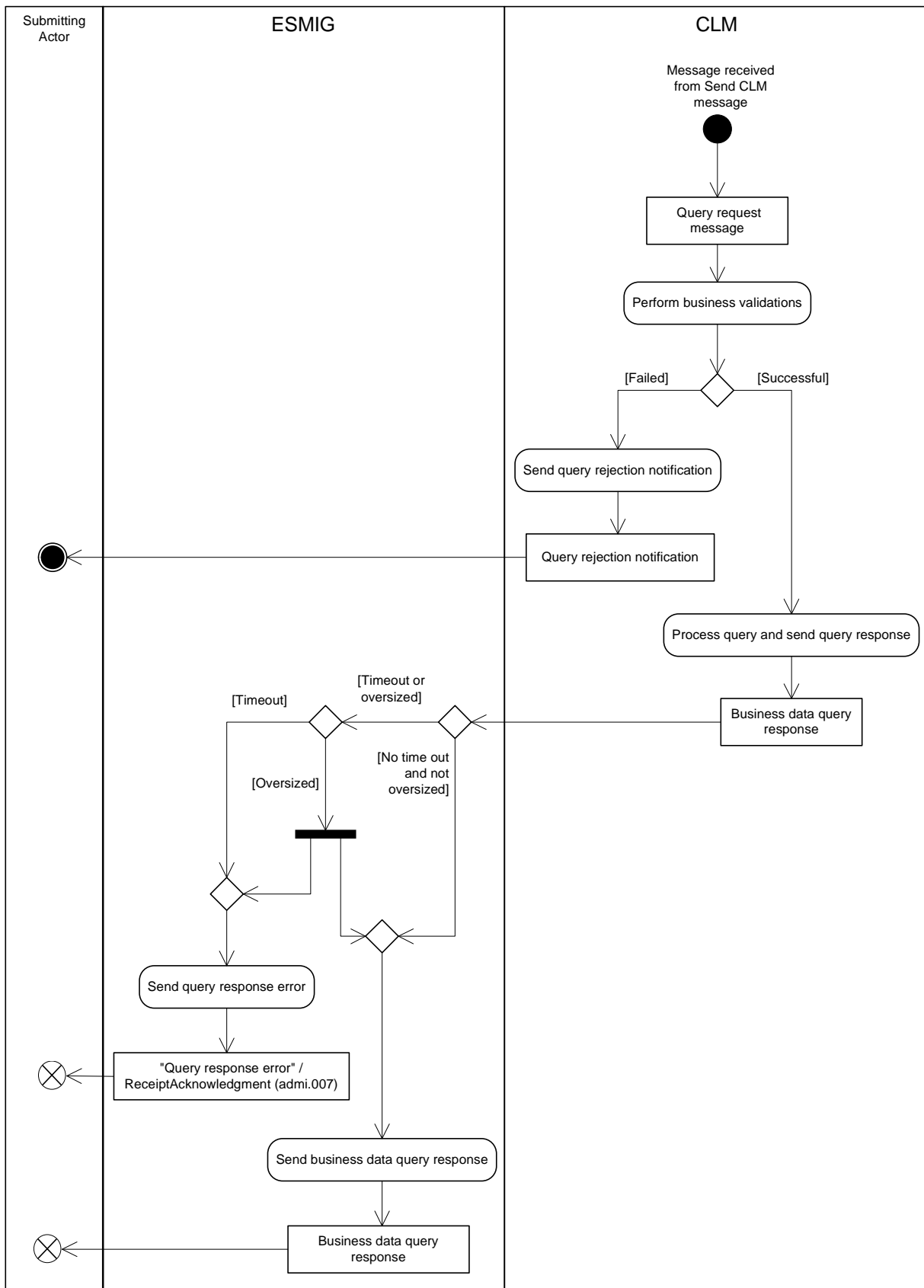

Figure 80 - Send CLM query

This process receives an individual message from the “Send message” process and continues with the step “Perform business validations”.

Perform business validations

The process verifies whether the query request is compliant with the business validation rules. The process performs the business validations to the extent possible in order to report the maximum number of validation errors to the submitting actor.

- I **[Failed]** The submitted query message is not compliant with the business validation rules for the query message. The processing continues with the step “Send query rejection notification”.
- I **[Successful]** The submitted query message complies with the business validation rules for the query message. The processing continues with the step “Process query and send query response”.

Send query rejection notification

The process step creates a “Send query rejection notification” and sends it to the submitting actor. The rejection message that the processing step generates depends on the submitted query message, as documented for the respective query in the column “Query rejection for failed business validation” in Table 88 - [A2A messages for query processing](#) [▶ 300].

Process query and send query response

The processing of the query extracts the required business data, creates the query response message as documented for the respective query in the column “Business data query response” in Table 88 - [A2A messages for query processing](#) [▶ 300]. When there is no timeout and the query response is not oversized, the processing continues with step “Send business data query response” in ESMIG. For oversize management the processing continues with a parallel flow resulting in the processing steps “Send query response error” in ESMIG and “Send business data query response” in ESMIG. ESMIG automatically sends the query response through the file channel when it determines an oversized query response. See chapter [Outbound traffic exceeding given size limitations](#) [▶ 322] for more information on how the Send business data query response is handled. The processing only continues with “Send query response error” in ESMIG for a timeout.

Send query response error

The ESMIG process step creates a “Query response error”/[ReceiptAcknowledgement \(admi.007\)](#) [▶ 370] and sends it to the submitting actor in order to close the real-time channel.

Send business data query response

The ESMIG process step sends the “Business data query response” and sends it to the submitting actor. For oversize management ESMIG sends the business data through the store-n-forward file-based network channel.

9.25.1.2 Messages

“Send CLM query” is a universal use case. Consequently, the use case applies to several query messages. The subsequent table provides a complete list of inbound and outbound messages used for each query:

Query	Query request message	Query rejection for failed business validation	Query response for business data
Account statement query	ReportQueryRequest (admi.005) [▶ 368]	ReceiptAcknowledgement (admi.007) [▶ 370]	In case the query response includes one page: BankToCustomerStatement (camt.053) [▶ 511] In case the query response includes more than one page: ⁸² ReceiptAcknowledgement (admi.007) [▶ 370]
Available liquidity CLM query	GetAccount (camt.003) [▶ 374]	ReturnAccount (camt.004) [▶ 380]	ReturnAccount (camt.004) [▶ 380]
Cash transfer query ⁸³	GetTransaction (camt.005) [▶ 411]	ReturnTransaction (camt.006) [▶ 434]	In case the query response includes one page: ReturnTransaction (camt.006) [▶ 434] In case the query response includes more than one page: ⁸⁴ ReceiptAcknowledgement (admi.007) [▶ 370]
Current reservations query	GetReservation (camt.046) [▶ 492]	ReturnReservation (camt.047) [▶ 495]	ReturnReservation (camt.047) [▶ 495]
Event query	GetBusinessDayInformation (camt.018) [▶ 466]	ReturnBusinessDayInformation (camt.019) [▶ 469]	ReturnBusinessDayInformation (camt.019) [▶ 469]
General Ledger query (CB)	ReportQueryRequest	ReceiptAcknowledgement	In case the query response

82 The UML diagram describes the answer via the real-time channel. The additionally provided query response via Store-n-Forward is not part of the diagram.

83 “This query is available in full and delta set.”

84 The UML diagram describes the answer via the real-time channel. The additionally provided query response via Store-n-Forward is not part of the diagram.

Query	Query request message	Query rejection for failed business validation	Query response for business data
only)	(admi.005) [▶ 368]	(admi.007) [370]	includes one page: General ledger (camt.053) [▶ 567] (General Ledger BankToCustomerStatement) In case the query response includes more than one page: ⁸⁵ ReceiptAcknowledgement (admi.007) [370]
Minimum reserve fulfilment query ⁸⁶	GetAccount (camt.003) [▶ 374]	ReturnAccount (camt.004) [▶ 380]	ReturnAccount (camt.004) [▶ 380]
Minimum reserve requirements query (CB only) ⁸⁷	GetAccount (camt.003) [374]	ReturnAccount (camt.004) [▶ 380]	ReturnAccount (camt.004) [▶ 380]
Penalty query (CB only)	GetPenaltyMinimumReserve (camt.998) - specific for CBs [588]	ReturnPenaltyMinimumReserve (camt.998) - specific for CBs [▶ 591]	ReturnPenaltyMinimumReserve (camt.998) - specific for CBs [▶ 591]
System time query	GetBusinessDayInformation (camt.018) [▶ 466]	ReturnBusinessDayInformation (camt.019) [469]	ReturnBusinessDayInformation (camt.019) [▶ 469]
Standing facilities transaction of the respective banking community query (CB only)	GetTransaction (camt.005) [411]	ReturnTransaction (camt.006) [▶ 434]	ReturnTransaction (camt.006) [▶ 434]

Table 88 - A2A messages for query processing

85 The UML diagram describes the answer via the real-time channel. The additionally provided query response via Store-n-Forward is not part of the diagram.

86 In case a CB wants to receive data for its banking community, only the respective request type codes shall be used without further search criteria.

87 In case a CB wants to receive data for its banking community, only the respective request type codes shall be used without further search criteria.

9.25.2 Receive CLM report

9.25.2.1 Description

A CLM Actor receives mandatory reports (i.e. general ledger) and may configure to receive optional reports (i.e. statement of account). This use case describes the general mechanism for the creation of all reports and their transmission to the receiving Actor requiring the reports. The use case covers the publishing of reports in push mode as well as their storage for later retrieval (pull mode). The chapter [CLM report generation](#) [▶ 161] describes the respective business scope.

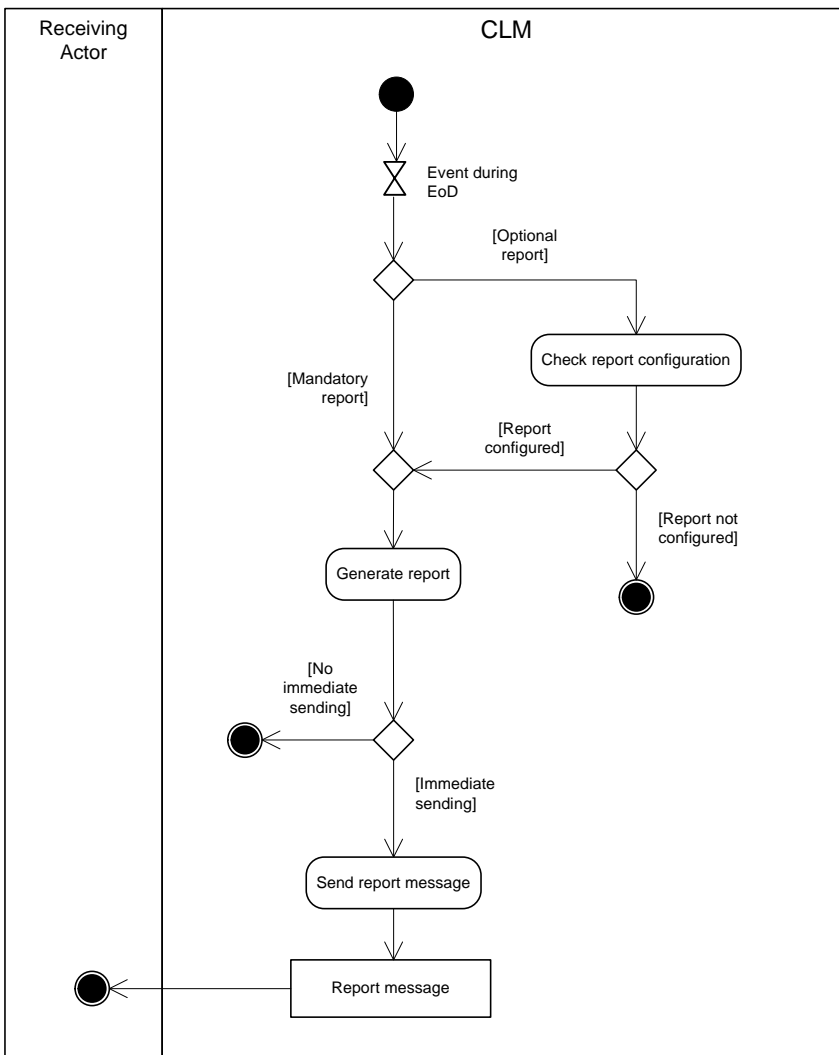

Figure 81 - Receive CLM report

During the EoD, the report generation is triggered. Further details on the business day are provided in chapter [End-of-day period \(18:00 - 18:45 CET\)](#) [▶ 87].

Check report configuration

The report processing checks whether a report configuration exists for an optional report, such as the statement of account. If a report configuration exists for a cash account in CLM, then the processing continues with “Generate report”. The process terminates for a cash account in CLM when no configuration for the respective optional report exists.

Generate report

The processing generates:

- I a mandatory report, as is the case for the general ledger file for CBs (see chapter [Collection of general ledger data and sending to CBs by CLM](#) [▶ 192]);
- I an optional report if a report configuration exists for a cash account in CLM.

The processing stores the report for a later retrieval. In case of the general ledger or a report configuration with push option, the processing continues with “Send report message”. Otherwise the processing terminates without delivering the report to the report receiving actor.

Send report message

This processing step sends the "Report message" as documented in the following table Outbound report messages immediately to the report receiving actor.

9.25.2.2 Messages

Report name	ISO message	ISO code
Statement of account	BankToCustomerStatement [▶ 511]	camt.053 [▶ 511]
General ledger (CB only)	BankToCustomerStatement [▶ 567]	camt.053 [▶ 567]

Table 89 - Outbound report messages

9.25.3 Receive CLM system notification

9.25.3.1 Description

CLM uses system notifications in order to provide CLM Actors regularly with a defined set of business events. The receipt of system notifications is subject to a message subscription:

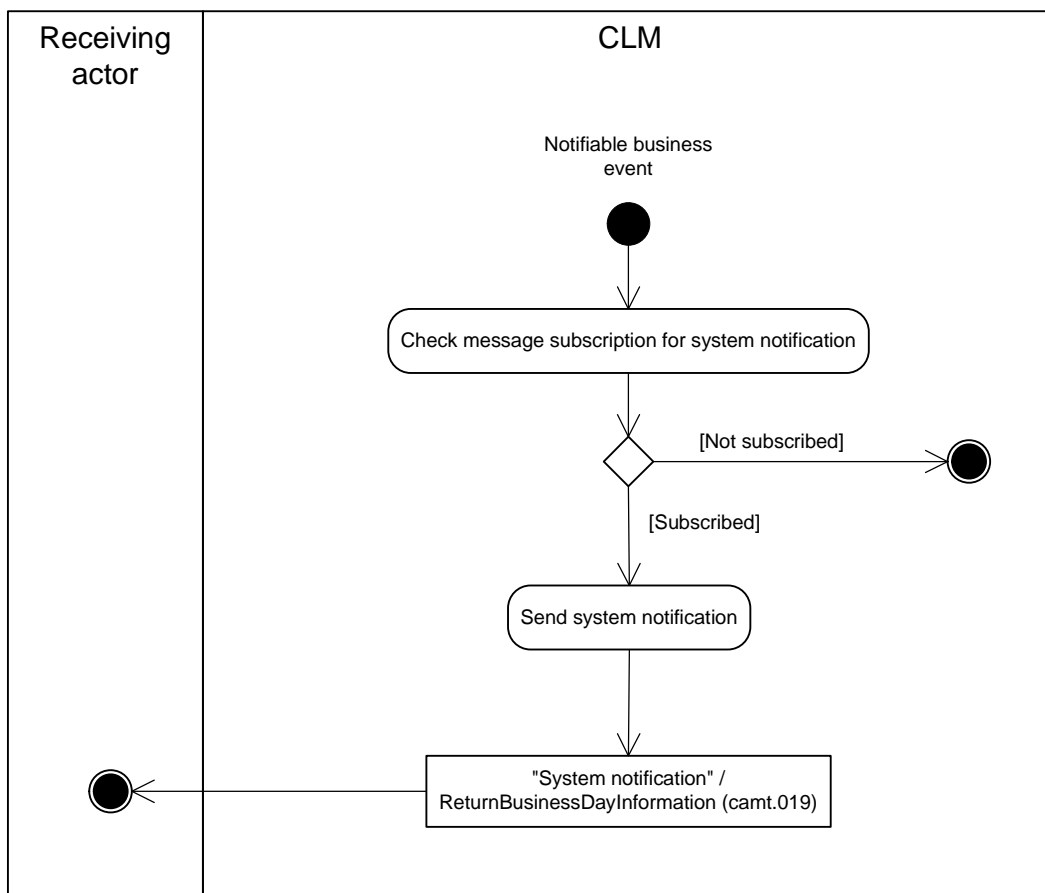

Figure 82 - Receive CLM system notification

Check message subscription for system notification

The receipt of a notifiable business event triggers a check of the message subscription to check whether a receiving actor has subscribed to the receiving system notifications. The process terminates when the receiving actor has no message subscription. In case the receiving actor opted for receiving system notifications, the processing continues with “Send system notification”.

Send system notification

When the receiving actor has subscribed to receive system notifications, then the process generates the “System notification”/[ReturnBusinessDayInformation \(camt.019\)](#) [▶ 469] message and sends it to the receiving actor.

9.25.3.2 Messages

Message description/usage	ISO message	ISO code
System notification	ReturnBusinessDayInformation [▶ 469]	camt.019 [▶ 469]

Table 90 - Outbound message for receive CLM system notification

9.25.4 Initiate CLM operations-related broadcast

This process initiates the sending of an A2A broadcast to each party in the list provided by the GUI and is triggered in case a CLM operations-related broadcast was entered in the GUI. The processing continues with the sub-process “[Process CLM operations-related broadcast](#) [▶ 305]”.

Further details on broadcasts can be found in chapter [Broadcasts](#) [▶ 168].

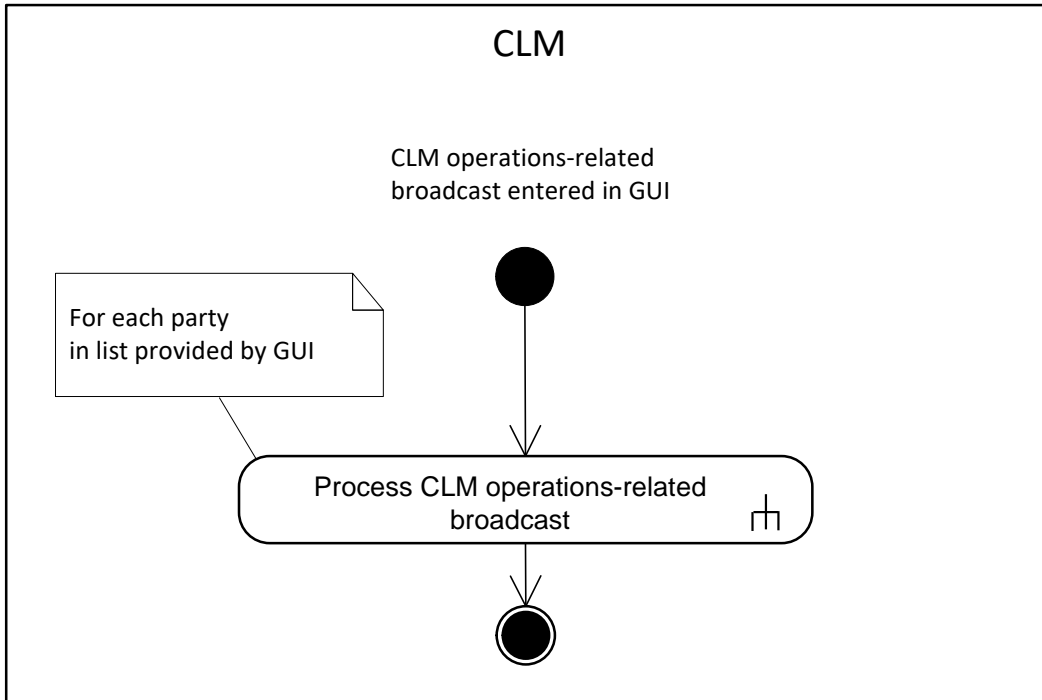

Figure 83 - Initiate CLM operations-related broadcast

9.25.5 Process CLM operations-related broadcast

9.25.5.1 Description

This sub-process sends an A2A broadcast via [SystemEventNotification \(admi.004\)](#) [▶ 365] to the broadcast subscribing party.

Note: The A2A broadcast is sent in addition to the U2A broadcast if the respective party has subscribed to receiving A2A broadcasts.

Further details on broadcasts can be found in chapter [Broadcasts](#) [▶ 168].

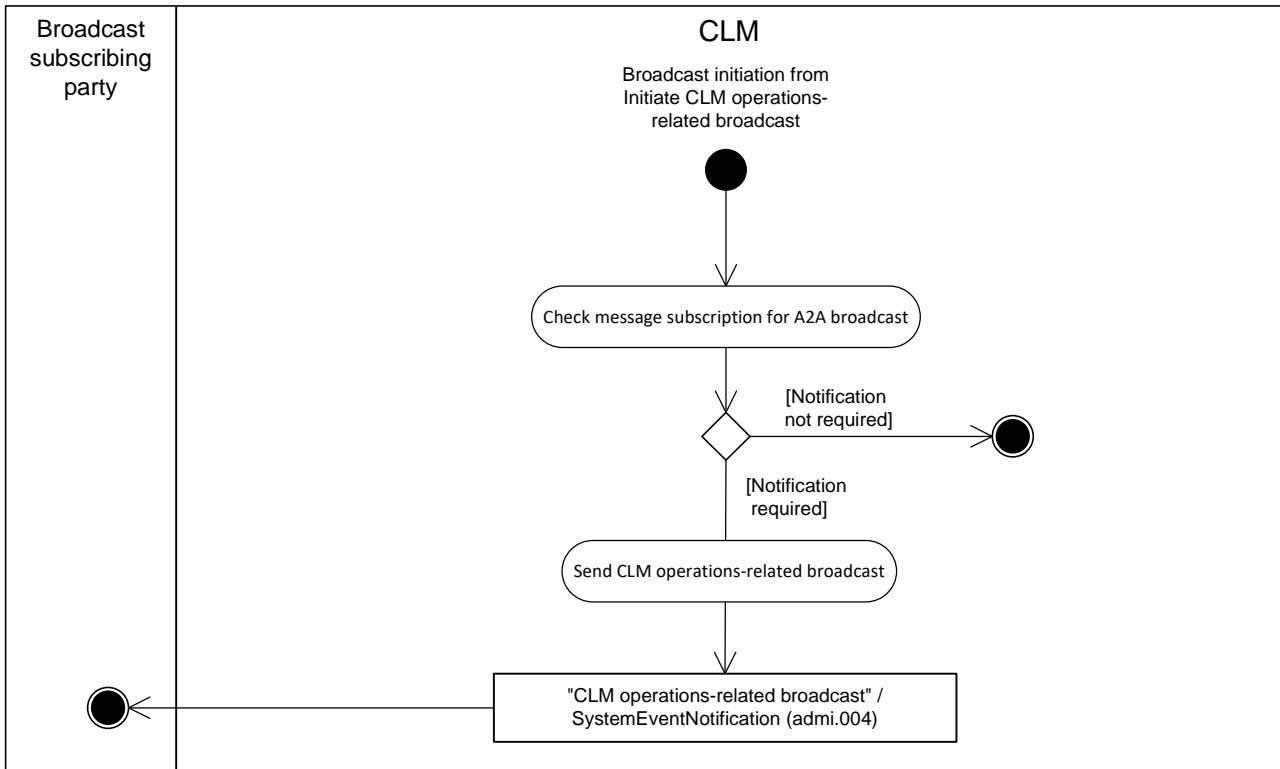

Figure 84 - Process CLM operations-related broadcast

This sub-process is triggered by the process [“Initiate CLM operations-related broadcast \[▶ 305\]”](#) and starts with the process step “Check message subscription for A2A broadcast”.

Check message subscription for A2A broadcast

This process step checks whether a message subscription for A2A broadcasts exists. In case such subscription exists, the processing continues with “Send CLM operations-related broadcast”.

Send CLM operations-related broadcast

This process step creates an "CLM operations-related broadcast"/[SystemEventNotification \(admi.004\)](#) [▶ 365] and sends it to the broadcast subscribing party.

9.25.5.2 Messages

Message description/usage	ISO message	ISO code
CLM operations-related broadcast	SystemEventNotification [▶ 365]	admi.004 [▶ 365]

Table 91 - Outbound messages for process CLM operations-related broadcast

Part III - Catalogue of messages

10 Messages - introduction

Following on from the formalised illustration of the application processes, the “Part III - Catalogue of messages” chapter provides a detailed description of the entire set of ISO messages - customised to the specific needs of CLM - available to the actors. The objective is to allow the reader to find the necessary information related to messaging which is needed to establish a functioning system of A2A communication.

The list of messages contains all the ISO messages required to support the actors' business processes. This content is framed by an introductory chapter [Messages - general information](#) [▶ 310] and a detailed appendix, followed by [List of messages specific for CBs](#) [▶ 560].

The introductory chapter “[Messages - General information](#) [▶ 310]” provides basic information on the concept of messaging or/and information applicable to all messages in CLM. The [Appendix](#) [▶ 642] of this UDFS contains comprehensive lists of relevant technical details for each message.

The messages described in chapter [List of messages](#) [▶ 364] are grouped according to the “business areas” used in ISO 20022 to facilitate orientation for the reader. Each message description consists of three chapters.

- I One chapter to explain the scope of the concerned message and to provide high-level information to the reader about its purpose.
- I One chapter to provide detailed information on the schema file corresponding to the relevant message. Besides providing an overview of the message's outline, this chapter contains a link to the online resources where the schema file in XSD- and Excel-format and the respective schema documentation in HTML- and PDF-format and the message examples can be accessed.
- I One chapter to illustrate in detail the different usages or query and instruction types in accordance with the use cases.

Overview and scope of the message

This chapter provides basic information about the scope of the message within the context of CLM. Besides illustrating the purpose of the message within the system, it informs about the sender and receiver of this particular message.

For an inbound message it mentions the possible different instructions or queries for the concerned message (if applicable) and informs the reader about the corresponding response message foreseen. For an outbound message it mentions the possible different usages covered by the message (if applicable).

Relevant usage descriptions for each message are listed in [Processes with CLM](#) [▶ 207].

Schema

This chapter starts with an outline of the message building blocks applicable to the schema. The reader can find guidance on whether this building block is optional or mandatory and what sort of information it contains.

The chapter also contains the respective hyperlinks for the online resources related to the message, including the in-depth schema file descriptions. The reader can access the schema file both in XSD and Excel format. These schema files were customised to the needs of the specific utilisation of the messages for CLM and hence contain explanatory annotations and definitions clarifying these possible specificities. Besides the schema file representation, the reader can access documentation available in HTML and PDF providing further explanations on the specific utilisation of the concerned message.

The customised schemas reflect the latest available status of the respective ISO message, i.e. they include all changes occurring during the regular ISO maintenance cycles for these messages. Under certain conditions, the schema documentation anticipates upcoming changes to the ISO messages which are caused by those ISO Change Requests launched specifically to cover CLM requirements. These changes are not yet incorporated into the schema files as their availability follows the yearly maintenance cycle. Within the schema documentation the reader is nonetheless informed about such changes in advance and can identify future changes to the messages already at this point in time.

The message in business context

This chapter provides a concrete example on the utilisation of the message in the CLM context.

For an inbound message with several purposes (instructions or queries) and for an outbound message with several usages, the chapter provides the specific set-up of the message in order to perform the foreseen task.

- I It provides the scope and details of the specific types of instructions/queries or usages, e.g. the query parameters applicable to the specific case.
- I In a sub-chapter entitled “Specific message requirements”, a message extract is provided in a table format showing the necessary elements of the message to fulfil the purpose described. The extract only depicts the part/s of the message required for the particular necessary configuration for the usage case and may thus deviate from the overall XML structure of the message.
- I A complete message sample in XML format provides the reader with a concrete example on how the message is to be used in a specific business situation which refers to the particular instruction/query or usage. All data used are fictional.

The specific schema is the sole source of information. To avoid doubt, the information contained in the “Specific message content”- tables is not designed to be stand-alone and must be understood only as clarifying the respective specific schema and the related schema documentation.

Within the “Utilisation” column of the tables the reader is familiarised with the relevant content of the concerned message element in the context of the concerned message usage or instruction/query type. This column does not include any sample data but provides generic information applicable to the message element. In cases where codes or values are listed in this column, they should be understood to be the

comprehensive set of all possible values for the element in the context of the concerned message usage or instruction/query type.

In the cases where a relationship is applicable to a set of messages, there are [Business scenarios](#) [▶ 334] defined.

11 Messages - general information

11.1 Message validation

11.1.1 Structure of ISO 20022 messages

Basic information on the XML schema

XML schema conforms to the compulsory overall structure foreseen for ISO 20022 messages.

Each schema requires an XML declaration. This declaration provides information on the used XML version and the applicable character set within the message. XML declarations do not have an end tag as they are not part of the XML document itself and hence do not constitute an XML element.

Below the XML declaration, all schema have a root element. This root element provides the name of the schema, including information on the variant and the version⁸⁸ of the schema. The actual content of the schema is hence a sub-element of the root element. Similar to all other elements within the schema, the root element also has an end tag at the end of the schema.

Example

The below example provides an indication of the overall structure of ISO 20022 messages:

```
<?xml version="1.0" encoding="UTF-8"?>
<Document xmlns="urn:iso:std:iso:20022:tech:xsd:DRAFT3admi.007.001.01">
  <RctAck>
    <MsgId>
      <MsgId>NONREF</MsgId>
    </MsgId>
    <Rpt>
      <RltdRef>
        <Ref>Inp009b008-BAHId</Ref>
      </RltdRef>
      <ReqHdlg>
        <StsCd>H001</StsCd>
        <Desc>Element Related is missing</Desc>
      </ReqHdlg>
    </Rpt>
  </RctAck>
</Document>
```

Figure 85 - XML structure, basic information

ISO 20022 message

88 A "variant" is a restricted version of a global message which fits the needs of a particular community while remaining in strict compliance with the original ISO 20022 message. For example, optional items can be removed or made mandatory, choices can be removed to keep no or fewer options, internal code lists can be reduced to the subset of codes that are actually used, size of text fields can be reduced, etc. A "version" helps to cater for the evolution of message requirements and for the correction of possible problems and errors of a message. Upon the publication of a new message version a message switches from one way of being used to a new way of being used. Each message (variant) usually has one current version, which is the most recent one. The former and the current version coexist for a certain while in order to ease the migration. Example: Within the ReturnAccount message camt.004.001.08 the number 001 reflects the variant of the message in use whereas the number 08 reflects the current version of the message variant in use. CLM makes only use of different message versions but not variants.

When being sent as an ISO 20022 message, an XML schema is referred to as message instance. The underlying schema file “explains” what makes up a valid message (i.e. it contains the necessary rules and definitions). The message instances itself consists of message components. Another term which specifies the partitioning within a message instance is the message item. Such a message item can be either a message building block or a message element. Message items which occur as XML tags within the message instance can appear at any level of nesting in the message.

A message building block is a message item which is specific to the concerned message (i.e. the user cannot find it in the ISO 20022 Data Dictionary). Within the corresponding schema of the message the building block must be defined as an immediate child of the message. This is not to be confused with reusable groupings of one or more message elements, known as message components (i.e. that the user can find in the ISO 20022 Data Dictionary).

Message components are items which are used for setting up a message. These message components contain a set of message elements. In ISO 20022 these message components are usually linked to a particular business component. A comprehensive overview of all standardised ISO 20022 message components is available in the Data Dictionary of ISO 20022.

Each message element is uniquely identified. In ISO 20022 these message elements are usually linked to a particular business element. Filled-in message elements occur as simple and complex data types. These data types specify the format of the possible values of a message element.

Simple data types serve as a prescription on how to fill the respective message element in the message instance.

Example

The simple type shown below prescribes the way in which the currency code must be entered:

```
<xs:simpleType name="ActiveCurrencyCode">  
  <xs:restriction base="xs:string">  
    <xs:pattern value="[A-Z]{3,3}"/>  
  </xs:restriction>  
</xs:simpleType>
```

Figure 86 - XML structure, simple datatype

Complex data types allow for choice and sequencing options within the message and do not (only) prescribe ways of filling message elements. They hence determine the structure of a message element.

Example

The complex type shown below allows for a choice on how to assure party identification in a message:

```
<xs:complexType name="FinancialInstitutionIdentification18_1">
  <xs:sequence>
    <xs:element name="BICFI" type="TARGET_BIC11Text" minOccurs="0" maxOccurs="1"/>
    <xs:element name="ClrSysMmbId" type="ClearingSystemMemberIdentification2_1" minOccurs="0" maxOccurs="1"/>
    <xs:element name="LEI" type="LEIIdentifier" minOccurs="0" maxOccurs="1"/>
    <xs:element name="Nm" type="TARGET_RestrictedFINXMax140Text_Extended" minOccurs="0" maxOccurs="1"/>
    <xs:element name="PstlAdr" type="PostalAddress24_1" minOccurs="0" maxOccurs="1"/>
  </xs:sequence>
</xs:complexType>
```

Figure 87 - XML structure, complex datatype

ISO 20022 classifies data types into standardised representation classes. These representation classes provide a set of possible data, which can be inserted into the concerned message element.

For example, the message element “Bank Identifier” can be assigned to the representation class “BICIdentifier” or the message element “Text” can be assigned to the representation class “Max35Text”.

Choice components allow the user of the message to choose between several possibilities. The message user may only choose one possible option in the instance.

11.1.2 CLM-specific schema customisation

Based upon the enriched ISO schema files for its messages, once available (i.e. after the enrichment of newly-developed messages or after the publication of maintained messages in the context of a new standards release) these schema files are customised to adapt them to the specificities applicable in the context of CLM.

The customisation of the schema files used in CLM follows a particular approach which combines the needs of the CLM Actors to have a coherent logic across the messages and the need within CLM to have a usable and efficient schema definition. CLM derived this approach from the following customisation principles:

- | customised CLM schema files are compliant with the initial ISO 20022 schema files;
- | when possible, CLM customisation drops all the message elements with no direct connection to the user requirements of CLM;
- | when possible, CLM customisation restricts element types to the CLM-specific usage;
- | CLM customisation defines the necessary content of mandatory fields which cannot be pruned (i.e. “removed”) from the ISO schema files;
- | CLM customisation restricts the list of possible code values to the sole codes allowed in CLM;
- | CLM customisation sets the length of the values to the length applicable in CLM;
- | CLM customisation sets the occurrence of message elements to the occurrence applicable in CLM;
- | CLM customisation makes optional message elements mandatory if their usage in CLM is always compulsory;
- | CLM customisation restricts the allowed characters to those used in CLM with a pattern;
- | CLM customisation restricts numeric fields applicable to CLM (e.g. for amounts).

Based on the chosen approach four scenarios apply to the customisation for CLM purposes:

1. a (part of a) message only contains elements which are supported by CLM and there is hence no need for any pruning;
2. CLM does not need a certain element but it cannot be pruned in the message because of a particular actor need and/or that element could be used in subsequent messages;
3. neither CLM nor CLM Actors need a certain element and therefore it is pruned;
4. neither CLM nor CLM Actors need a certain element but as mandatory element in the ISO schema file it cannot be pruned and may be filled with a dummy value in CLM.

For the scenarios 1, 3 and 4, CLM only allows message elements according to the customised schema file. CLM rejects any inbound message containing message elements which are not part of the CLM customised schema file. Message elements under the scope of scenario 4 are not subject to further processing in CLM. CLM Actors can hence fill these fields either with dummy values or real data (inserting real data does not lead to any processing, either).

For scenario 2 an alternative procedure applies. If message elements are present in the message and in CLM customised schema file although the message element is per se dispensable, CLM nevertheless processes the message. For these message elements only technical validations are applicable. CLM does not validate these elements against its business rules.

However, for all messages, CLM prunes elements which are not within the general scope of its functionalities.

Note: CLM restricts character fields to not allow leading or trailing whitespaces.

CLM rejects messages during technical validation in cases where actors:

- l use elements in the message which are not present in the CLM customised schema file;
- l use values in allowed elements but do not respect the restrictions of these values foreseen in the CLM customised schema.

For CLM outbound messages the logic for filling message elements customised to be optional is derived from the concrete circumstances and purposes of the concerned messages:

- l for query response messages the filled message elements for outbound messages are those necessary to convey the information requested by the corresponding query message;
- l for report messages the same applies, in accordance to the concrete configuration for the subscribed reports.

For any other CLM outbound message the filling of optional fields also depends either on:

- l the corresponding inbound message with its specific intention;
- l the purpose of the CLM-generated outbound message in case no inbound message precedes.

Some of the optional elements in the XML messages are not relevant for CLM backend processing. Therefore not every optional field is detailed in the UDFS. However they are provided in the schema, as they can be of use for external actors for their business requirements in relation to other actors than CLM.

The chapter “The message in business context” may contain message usages and/or message samples in which the content of given fields for a specific purpose or as a reply to a specific inbound message are depicted.

11.1.3 XML character set

UTF-8 is a Unicode character encoding of variable length. It has the capacity to represent every character of the Unicode character set and is backwards compatible to ASCII (in contrast to UTF-16 or UTF-32). In the vast majority of character representations in UTF-8 it only takes one byte to code one character.⁸⁹

UTF-8 is part of the ISO 10646 scheme which was published as a first draft in 1990. The idea is to assign a unique code point to every character (i.e. letters, numbers, symbols, ideograms, etc.) covered by this standard. Whereas the standard foresees a maximum amount of 1.1 million of such code points some 100.000 are attributed to abstract characters for the time being. The inclusiveness, however, is steadily augmenting as characters from previously unrepresented writing systems are added.

The ISO website offers a free-of-charge download of the complete definition of the ISO 10646 standard including all the later amendments (e.g. of additional languages).

In principle ISO 20022 caters for UTF8. CLM follows the approach of High Value Payments Plus (HVPS+) supported character set, limited to basic latin characters and additional special characters:

Character set type	Message elements	Supported characters in T2				
Restricted TARGET character set	All elements with data type “Text”, except the element categories listed for Extended TARGET character set (see below).	Use of FIN X-Character Set: abcdefghijklmnopqrstuvwxyz ABCDEFGHIJKLMNOPQRSTUVWXYZ 0123456789 /?:()., '+ Space				
Extended TARGET character set	-All Name elements for all actors -Remittance Information	Use of FIN X-Character set (see above), plus !#\$%&*^_`{ }~ ";<>@[N]. Note: The following characters need to be escaped: <table border="1" data-bbox="906 1749 1439 1906"> <thead> <tr> <th>Character</th> <th>XML Escape Sequence</th> </tr> </thead> <tbody> <tr> <td><</td> <td>&lt;</td> </tr> </tbody> </table>	Character	XML Escape Sequence	<	<
Character	XML Escape Sequence					
<	<					

89 UTF-8 uses a single byte to represent 7-bit ASCII characters. Representation of extended characters takes between two and six bytes and hence, between 14 and 42 bits.

Character set type	Message elements	Supported characters in T2	
		>	>
		&	&

Table 92 - Supported character sets

Leading and trailing whitespaces are not allowed. This is efficiently ensured by schema validation in all messages.

11.1.3.1 Technical validation

All ISO 20022 messages which arrive at the CLM interface for further processing are subject to validation rules related to the syntax and structure of the message itself. In this context one can distinguish between well-formedness and validity of the message sent to CLM.

An ISO 20022 message is well-formed if it satisfies the general syntactical rules foreseen for XML documents as outlined in the above chapter. The major aspects to be respected are the following.

- | the message only contains properly encoded unicode characters;
- | the specific syntax characters (e.g. "<" and "&") are not used in the message except in their function as mark-up delineation (it is feasible to use those characters if they are "escaped" as mentioned in the previous chapter, i.e. "<" is escaped with "<" and "&" is escaped with "&");
- | the element-delimiting tags (i.e. start, end and empty-element tags) are correctly nested and paired and none of them is missing or overlapping;
- | the start and end tags match exactly and are case-sensitive;
- | the message has one root element which contains all other elements.

In contrast to other forms of representation the definition of XML documents is rather strict. XML processors cannot produce reasonable results if they encounter even slight violations against the principle of well-formedness. Any violation of this well-formedness automatically entails an interruption of the message processing and an error notification to the sender.

Every well-formed ISO 20022 message arriving in the CLM interface undergoes a validity check according to the rules contained in the enriched CLM schema files. These CLM enriched schemas make the structure of the message visible to the user and provide all necessary explanations on the validations the message undergoes.

The CLM enriched schema files serve different purposes:

- | they provide a definition of all the elements and attributes in the message;
- | they provide a definition on what elements are child elements and on their specific order and number;
- | they provide a definition of the data types applicable to a specific element or attribute;
- | they provide a definition of the possible values applicable to a specific element or attribute.

CLM provides the CLM enriched schema file description in several formats: in XSD, Excel and PDF on MyStandards. This shall allow the user to accommodate himself with the format of his choice while having recourse to computer processable information to the largest extent.

A short extract from an XML message for exemplary purposes (ISO 20022 standard message):

```
<?xml version="1.0" encoding="UTF-8"?>
<Document xmlns="urn:iso:std:iso:20022:tech:xsd:pacs.009.001.08">
  <FICdtTrf>
    <GrpHdr>
      <MsgId>NONREF</MsgId>
      <CreDtTm>2019-10-07T17:35:00+00:00</CreDtTm>
      <NbOfTxs>1</NbOfTxs>
      <SttlmInf>
        <SttlmMtd>CLRG</SttlmMtd>
        <ClrSys>
          <Cd>TGT</Cd>
        </ClrSys>
      </SttlmInf>
    </GrpHdr>
    <CdtTrfTxInf>
      <PmtId>
        <InstrId>Inp009b001-InsId</InstrId>
        <EndToEndId> Inp009b001-E2EId</EndToEndId>
        <UETR>e009b001-59c5-41e9-be4c-d45102fc201e</UETR>
      </PmtId>
      <IntrBkSttlmAmt Ccy="EUR">85000.00</IntrBkSttlmAmt>
      <IntrBkSttlmDt>2019-10-27</IntrBkSttlmDt>
      <InstgAgnt>
        <FinInstnId>
          <BICFI>COBADEFFXXX</BICFI>
        </FinInstnId>
      </InstgAgnt>
      <InstdAgnt>
        <FinInstnId>
          <BICFI>SOLADESTXXX</BICFI>
        </FinInstnId>
      </InstdAgnt>
      <Dbtr>
        <FinInstnId>
          <BICFI>COBADEFFXXX</BICFI>
        </FinInstnId>
      </Dbtr>
      <Cdtr>
        <FinInstnId>
          <BICFI>SOLADESTXXX</BICFI>
        </FinInstnId>
      </Cdtr>
    </CdtTrfTxInf>
  </FICdtTrf>
</Document>
```

Figure 88 - Technical validation, ISO schema example

Based on the relevant CLM enriched schema, the CLM interface performs the following validations for each incoming message instance:

- | validation of the XML structure (starting from the root element);
- | validation of the element sequencing (i.e. their prescribed order);
- | validation of the correctness of parent-child and sibling relations between the various elements;
- | validation of the cardinality of message elements (e.g. if all mandatory elements are present or if the overall number of occurrences is allowed);
- | validation of the choice options between the message elements;
- | validation of the correctness of the used character set;
- | validation of the correctness of the code list values and their format.

Regarding the use of namespace prefixes, CLM does not encourage but accepts and processes valid inbound messages and inbound files composed of one or several messages containing those. However, when sending outbound messages, CLM does not re-use nor add namespace prefixes.

11.1.3.2 Business validation

Besides validations which verify the correctness of the ISO 20022 message as XML document itself CLM also conducts validations which are based on the business context CLM operates in.

This business validation in CLM takes place on the basis of a set of pre-defined business rules which are available in the [Appendix](#) [▶ 642] to this document.

On a general level CLM verifies the validity of the transmitted message content against its reference data repository.

In case of violations against existing business rules, CLM transmits them to the relevant CLM Actors directly via an outbound message. This message contains all the information the CLM Actor needs to fully understand why e.g. an intended step of processing could not be completed by the system.

This example shows an extract of a [Receipt \(camt.025\)](#) [▶ 479] sent to the case of a business rule violation (CLM_Receipt_Response [Receipt \(camt.025\)](#) [▶ 479] to [LiquidityCreditTransfer \(camt.050\)](#) [▶ 505] liquidity movement MCA-to-MCA to business sender, rejected):

```
<Rct>
  <MsgHdr>
    <MsgId>NONREF</MsgId>
    <ReqTp>
      <Prtry>
        <Id>VSTS</Id>
      </Prtry>
    </ReqTp>
  </MsgHdr>
  <RctDtls>
    <OrgnlMsgId>
      <MsgId>Inc050b051-BAHId</MsgId>
    </OrgnlMsgId>
    <ReqHdlg>
      <StsCd>E042</StsCd>
      <Desc>Insufficient liquidity to debit account</Desc>
    </ReqHdlg>
  </RctDtls>
</Rct>
```

Figure 89 - Business validation, response example

CLM messages rely on “External Code Sets” for some elements. CLM message elements with a data type starting with “External”, e.g. ExternalLocalInstrument1Code, ExternalReason1Code or ExternalCategoryPurpose1Code, should be filled with such codes, which are published in a spreadsheet on the ISO 20022 homepage. If the code to be used is relevant for CLM processing, this is outlined in the relevant message element. For all other cases, CLM will not check the message against the values available in the spreadsheet.

11.2 Communication infrastructure

11.2.1 Envelope messages

In order to communicate with CLM, a business sender may send a single business message or a file containing several business messages. The structure of message is described in chapter [Business Application Header](#) [▶ 318] and the structure of file is described in chapter [Business File Header](#) [▶ 319].

BAH and business payload/ISO 20022 message instance are part of this business message. Examples and further details for BAH are provided in chapter [BusinessApplicationHeader \(head.001\)](#) [▶ 549].

11.2.1.1 Business Application Header

The [BusinessApplicationHeader \(head.001\)](#) [▶ 549] (BAH) is defined in general for all inbound and outbound messages sent to and from CLM.

The BAH is not applicable when:

- | [ReceiptAcknowledgement \(admi.007\)](#) [▶ 370] is sent to acknowledge technical validation error(s) identified during the “Send CLM message” process within CLM;
- | [ReceiptAcknowledgement \(admi.007\)](#) [▶ 370] is sent to acknowledge technical validation error(s) identified during the “[Send CLM file](#) [▶ 209]” process within CLM.

Technically speaking, the BAH is a separate XML document/ISO 20022 message standing apart from the XML documents which represent the message instance itself. For the basic structure of business message see below:



Figure 90 - BAH

The BAH facilitates the message processing as it stores the information necessary for the processing at one central place. A uniform appearance (structure) of relevant information in the BAH improves the routing of the business message once it arrives at the addressee's interface.

BAH and business payload/ISO 20022 message instance are part of this business message. Examples and further details for BAH are provided in chapter [BusinessApplicationHeader \(head.001\)](#) [▶ 549].

11.2.1.2 Business File Header

Besides the sending of single business messages CLM supports inbound files. Therefore, it is possible for business sender to send files composed of one or several business messages to CLM. The number of messages and the business areas of the single messages within a file are per se not restricted. In the case that file size exceeds the maximum size for file submission the relevant information for handling of that is provided in [Inbound and Outbound message size limitations](#) [▶ 322]. CLM uses a [BusinessFileHeader \(head.002\)](#) [▶ 555] (BFH) to assure the appropriate processing of such message batch. The file structure within CLM is compliant to the requirement of the "Giovannini Protocol: File Transfer Rulebook (May 2007)".

Files submitted to CLM should only contain instruction messages. If a submitted file contains query messages, CLM will filter out the query messages and reject them each individually. This will not impact any instruction messages contained in the file, which will be processed as normal. The rejection of the query messages is caused by the fact that files are submitted via store-n-forward network service, which is not allowed for inbound query messages.

CLM divides the inbound file into single business messages. Every business message is subject to separate validations (technical validations). Each business message is composed of a BAH and a business payload/ISO 20022 message, and is wrapped by a technical envelope called the head.003 wrapper. CLM reports errors on message level either by the corresponding response message or by a status message.

For this basic structure of file see below:

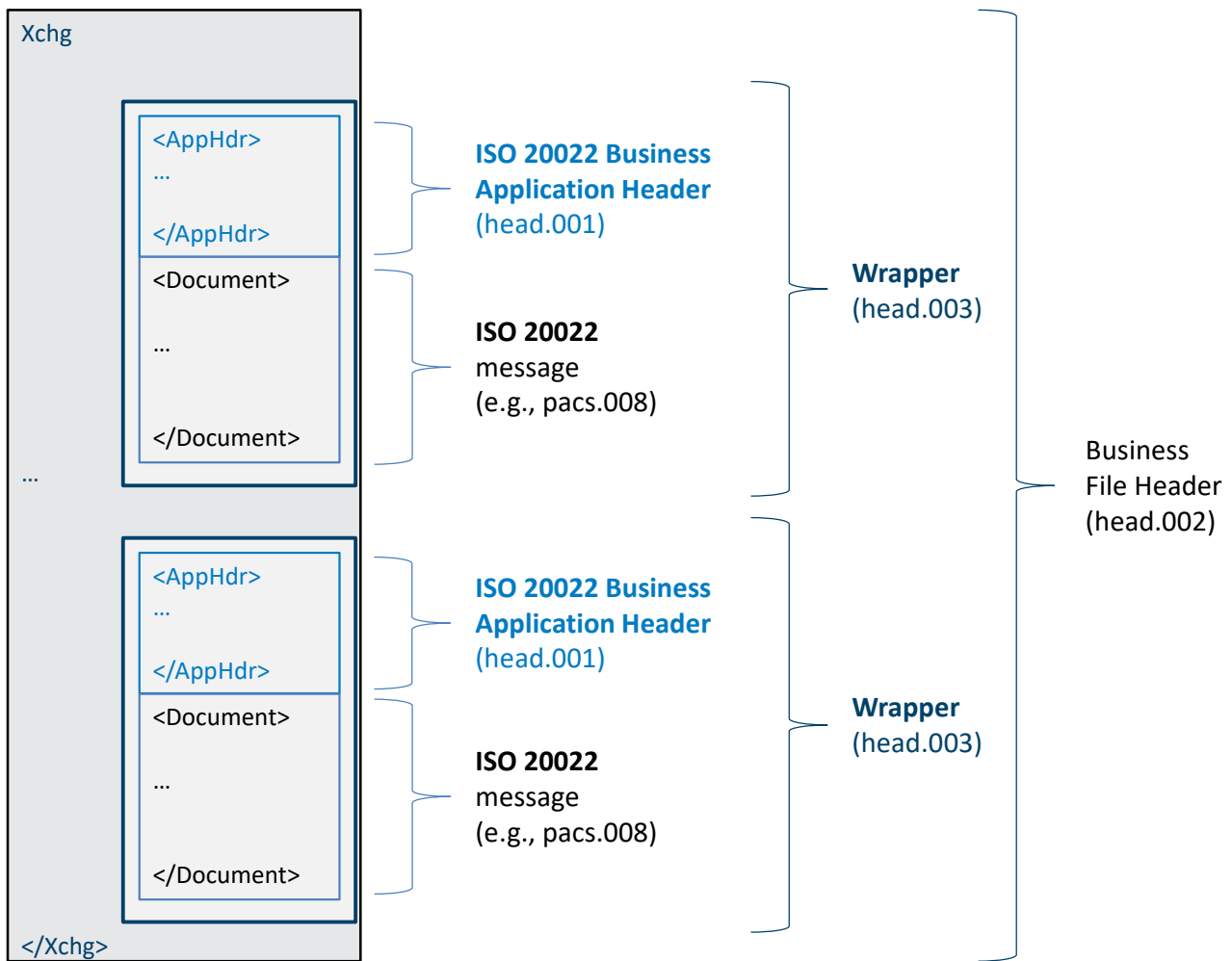

Figure 91 - BFH

Examples and further details for BFH are provided in chapter [BusinessFileHeader \(head.002\)](#) [▶ 555].

11.2.2 Processing time information

Messages exchanged between CLM and business senders and receivers consist of the BAH and the business payload. Both are parts of the business message containing time information. In the case of the use of a BFH (inbound only), there is an additional mandatory time information provided.

The relevant time reference for all inbound and outbound communication with CLM is UTC. All time information contained in CLM business messages inbound and outbound (based on given timestamps) are expressed with +/- mandatory time offset to UTC.

Inbound messages sent to CLM contain time information +/- time offset to UTC.

Outbound messages sent from CLM to business receiver contain:

- | time information provided by CLM: UTC;
- | time information from inbound message: time information provided in inbound message.

The following table illustrates the particularities for time information depending on the location of the business sender for winter time:

Location business sender	Local time business sender	Inbound: Used time in message element FromTime	Booking time in CET	CLM system time in UTC	Notification: Booking time stamp expressed in UTC added by CLM	Query response: Time provided in FromTime
Frankfurt	08:00 CET	08:00:00+01:00	08:00	07:00	07:00:00.001+00:00	08:00:00+01:00
Lisbon	07:00 WET (= UTC)	07:00:00+00:00				07:00:00+00:00
Athens	09:00 EET	09:00:00+02:00				09:00:00+02:00

Table 93 - Time information depending on the location of the business sender for winter time

Due to the ISO definition of the BAH, the time information within the BAH is normalised to ZULU time. CLM users must take a possible difference between the two time information into account when exchanging business messages with CLM.

Example

A message sent to CLM on 17 December 2021 at 10:30:47 local time CET would need to be expressed in the following field in the BAH (“ZULU time”⁹⁰):

```
<CreDt>2021-12-17T09:30:47Z</CreDt>
```

In the case the respective business payload contains an additional reference to the creation date and time, it would need to be expressed (“time information +/- time offset to UTC”) as follows:

```
<CreDtTm>2021-12-17T10:30:47+01:00</CreDtTm>
```

A message sent from CLM on 15 July 2022 at 11:30:47 local time CEST would need to be expressed in the following field in the BAH (“ZULU time”):

```
<CreDt>2022-07-15T09:30:47.001Z</CreDt>
```

In the case the respective business payload contains an additional reference to the creation date and time, it would need to be expressed (“time information +/- time offset to UTC”) as follows:

```
<CreDtTm>2022-07-15T09:30:47.001+00:00</CreDtTm>
```

The time offset is required by schema validation within the business payload and BFH, which is taken into account for further processing within CLM.

90 ZULU time (= UTC) is the used format for the time indication in the BAH.

In the communication process between CLM and the business senders and receivers the time information elements are used to indicate:

- | creation time of a message;
- | settlement time request (e.g. payment orders);
- | settlement execution time (only applicable outbound).

Depending on the specific processing of a message the time information will be processed in different ways.

In the CLM inbound case any ISO Time compliant data format amended by mandatory time shift information will be accepted, which means in particular also with or without milliseconds, e.g. settlement time request <FrTm>10:30:00+01:00</FrTm>.

In the CLM outbound case all time information generated by CLM including, seconds and milliseconds, are provided.

11.2.3 Inbound and Outbound message size limitations

Messages sent to or from CLM are subject to technical size limitations.

This chapter outlines which network service should be used for communication between CLM actors' back-end applications and CLM in relation to size of a message.

In particular, the use of a certain communication channel depends on two factors:

- | business purpose of a message (e.g. instruction or query etc.)
- | message size.

Hence, this chapter should be read in conjunction with chapter [Communication between CLM and CLM Actors](#) [▶ 38], which explains the choice of the right network service.

The message exchange limitations, i.e. system limitations are defined at a size of 32 KB and 32 MB both for inbound and outbound messages.

Network service	Maximum size
Message-based	32 KB (KB=2 ¹⁰)
File-based	32 MB (MB=2 ²⁰)

Table 94 - Message size

Note: The system limitations purely relate to the size of exchanged messages, i.e. it is completely decoupled from the terminology of 'file' in context with [BusinessFileHeader \(head.002\)](#) [▶ 555]. Meaning that also a 'file' with envelope [BusinessFileHeader \(head.002\)](#) [▶ 555] can be sent via store-n-forward message-based network service if the message size does not exceed 32 KB. Likewise, a "message" with envelope

[BusinessApplicationHeader \(head.001\)](#) [▶ 549] can be sent via store-n-forward file-based network service if the message size does not exceed 32 MB.

CLM inbound

Depending on the size of each message, or file, following network services are provided:

- | message-based network service (real-time or if applicable, store-n-forward);
- | file-based network service (only store-n-forward);

To fulfil the network service specific requirements, the CLM Actors have to consider that the message-based network service is limited to submissions of up to 32 KB whereas the file-based network service allows submissions of up to 32 MB.

CLM outbound

The rules put forward in the above paragraph are also applicable for outbound messages.

For a query received via real-time message-based network service, if the query response exceeds the given 32 KB size limitation, the network service will be switched to message-based network service. ESMIG then sends a [ReceiptAcknowledgement](#) [▶ 370] message ([admi.007](#)) [▶ 370] to inform the business sender of the query using the original real-time message-based network about the switch of network service. For further information, see ESMIG UDFS, chapter “*ESMIG data exchange information*”.

In case a query response, or a report also exceeds the maximum size of file-based network service of 32 MB, the CLM outbound message will be split in several parts. This may be the case for: [BankToCustomerStatement \(camt.053\)](#) [▶ 511] (statement of account is considered as both a query response and a report) and [ReturnTransaction \(camt.006\)](#) [▶ 434].

To advise that a query response or a report was split, the business payload element <MsgPgntn> is used to indicate “pagination” for [ReturnTransaction \(camt.006\)](#) [▶ 434] and [BankToCustomerStatement \(camt.053\)](#) [▶ 511].

For the [camt.053 BankToCustomerStatement](#) [▶ 511], a specific procedure has been defined for CLM. The convention is to split the payload at element BkToCstmrStmt/Stmt/Ntry.

When ‘splitting’ happens, the subsequent page starts with a repetition of the information in the <Stmt> block as in the previous page (repeating the account number and the relating balances) and continues in the <Ntry> block by listing all account entries that did not fit in the previous page.

CLM ensures that the fixed elements plus the repetitive elements do not exceed 32 MB.

11.3 Usage of Messages

The following table lists the usage of all CLM messages⁹¹ as described in chapter [Processes with CLM](#) [▶ 207] in Part II. Each message usage in the table is referenced as “usage case” in the sub-chapter “The message in business context” of each message.

The purpose of this chapter is to link Part II and Part III of CLM UDFS in order to navigate easily between the [Processes with CLM](#) [▶ 207] (descriptions and utilised messages) and the detailed message descriptions in [List of messages](#) [▶ 364] and [List of messages specific for CBs](#) [▶ 560]. Furthermore, this chapter provides an overview of all processes within CLM to the business reader.

Each message sub-chapter in Part III points to the table. In turn, the table points to the corresponding Part II process.

Conversely, each Part II process lists the messages involved, and the reader can navigate directly to the message sub chapter in Part III.

ISO Message	UDFS Chapter	Message Usage	Inbound/Outbound
admi.004 [▶ 365]	Process CLM operations-related broadcast [▶ 305]	CLM operations-related broadcast	Outbound
	Process CLM reject time broadcast [▶ 241]	Reject time broadcast	Outbound
admi.005 [▶ 368]	Send CLM query [▶ 297]	Query request message - general ledger [▶ 567] query (CB only)	Inbound
	Send CLM query [▶ 297]	Query request message - account statement query	Inbound
admi.007 [▶ 370]	Send CLM message [▶ 211]	Message rejection notification	Outbound
	Send CLM query [▶ 297]	Query rejection for failed business validation - account statement query	Outbound
	Send CLM query [▶ 297]	Query rejection for failed business validation - general ledger [▶ 567] query (CB only)	Outbound
	Send CLM file [▶ 209]	File rejection notification	Outbound

91 Not every message usage is illustrated with a message example.

ISO Message	UDFS Chapter	Message Usage	Inbound/Outbound
	Send CLM query [▶ 297]	Account statement query (in case the query response includes more than one page)	Outbound
	Send CLM query [▶ 297]	Cash transfer query (in case the query response includes more than one page)	Outbound
	Send CLM query [▶ 297]	General Ledger [▶ 567] query (CB only) (in case the query response includes more than one page)	Outbound
camt.003 [▶ 374]	Send CLM query [▶ 297]	Query request message - available liquidity CLM query	Inbound
	Send CLM query [▶ 297]	Query request message - minimum reserve fulfilment query	Inbound
	Send CLM query [▶ 297]	Query request message - minimum reserve requirement query (CB only)	Inbound
camt.004 [▶ 380]	Process automatic marginal lending - setting up - before and after launch of ECMS [▶ 280]	Spillover notification	Outbound
	Send CLM query [▶ 297]	Query rejection for failed business validation - available liquidity CLM query	Outbound
	Send CLM query [▶ 297]	Query rejection for failed business validation - minimum reserve fulfilment query	Outbound
	Send CLM query [▶ 297]	Query rejection for failed business validation - minimum reserve requirement query (CB only)	Outbound
	Send CLM query [▶ 297]	Query response for business	Outbound

ISO Message	UDFS Chapter	Message Usage	Inbound/Outbound
		data - available liquidity CLM query	
	Send CLM query [297]	Query response for business data - minimum reserve fulfilment query	Outbound
	Send CLM query [297]	Query response for business data - minimum reserve requirement query (CB only)	Outbound
	Process CLM floor and ceiling [237]	Floor/ceiling notification	Outbound
camt.005 [411]	Send CLM query [297]	Query request message - standing facilities transaction of the respective banking community query (CB only)	Inbound
	Send CLM query [297]	Query request message - cash transfer query	Inbound
camt.006 [434]	Send CLM query [297]	Query rejection for failed business validation - cash transfer query	Outbound
	Send CLM query [297]	Query rejection for failed business validation - standing facilities transaction of the respective banking community query (CB only)	Outbound
	Send CLM query [297]	Query response for business data - cash transfer query	Outbound
	Send CLM query [297]	Query response for business data - standing facilities transaction of the respective banking community query (CB only)	Outbound
camt.018 [466]	Send CLM query [297]	Query request message - event query	Inbound
	Send CLM query [297]	Query request message - system time query	Inbound

ISO Message	UDFS Chapter	Message Usage	Inbound/Outbound
camt.019 [▶ 469]	Send CLM query [▶ 297]	Query rejection for failed business validation - event query	Outbound
	Send CLM query [▶ 297]	Query rejection for failed business validation - system time query	Outbound
	Send CLM query [▶ 297]	Query response for business data - event query	Outbound
	Send CLM query [▶ 297]	Query response for business data - system time query	Outbound
	Receive CLM system notification [▶ 303]	System notification	Outbound
camt.025 [▶ 479]	Modify credit line [▶ 247]	Credit line modification rejection notification	Outbound
	Modify credit line [▶ 247]	Credit line modification execution notification	Outbound
	Modify credit line [▶ 247]	Credit line modification queuing notification	Outbound
	Reject pending credit line modification [▶ 252]	Credit line modification rejection notification	Outbound
	Manage current reservation in CLM [▶ 253]	Current reservation modification/deletion rejection notification	Outbound
	Manage current reservation in CLM [▶ 253]	Current reservation modification/deletion execution notification	Outbound
	Manage current reservation in CLM [▶ 253]	Current reservation modification queuing notification	Outbound
	Maintain minimum reserve requirement order [▶ 285]	Maintain minimum reserve requirement order rejection notification	Outbound
	Maintain minimum reserve requirement order [▶ 285]	Maintain minimum reserve requirement execution	Outbound

ISO Message	UDFS Chapter	Message Usage	Inbound/Outbound
		notification	
	Reject pending reservation modification in CLM [▶ 257]	Current reservation modification rejection notification	Outbound
	Insert or adjust balance for minimum reserve fulfilment [287]	Insert or adjust balance for minimum reserve fulfilment order rejection notification	Outbound
	Insert or adjust balance for minimum reserve fulfilment [▶ 287]	Insert or adjust balance for minimum reserve fulfilment execution notification	Outbound
	Administrate minimum reserve penalty order [▶ 293]	Administrate minimum reserve penalty order rejection notification	Outbound
	Administrate minimum reserve penalty order [▶ 293]	Administrate minimum reserve penalty order execution notification	Outbound
	Process CLM payment order and liquidity transfer order [213]	Liquidity transfer order rejection notification	Outbound
	Perform standard CLM settlement [▶ 223]	Liquidity transfer order settlement notification	Outbound
	Perform standard CLM settlement [▶ 223]	Liquidity transfer order fail notification	Outbound
camt.029 [▶ 561]	Perform CLM payment order revocation [▶ 216]	Payment order revocation execution notification	Outbound
	Perform CLM payment order revocation [▶ 216]	Revocation rejection notification	Outbound
camt.046 [▶ 492]	Send CLM query [▶ 297]	Query request message - current reservations query	Inbound
camt.047 [▶ 495]	Send CLM query [297]	Query rejection for failed business validation - current reservations query	Outbound
	Send CLM query [▶ 297]	Query response for business data - current reservations	Outbound

ISO Message	UDFS Chapter	Message Usage	Inbound/Outbound
		query	
camt.048 [▶ 499]	Manage current reservation in CLM [▶ 253]	Current reservation modification	Inbound
camt.049 [▶ 502]	Manage current reservation in CLM [▶ 253]	Current reservation deletion	Inbound
camt.050 [▶ 505]	Process CLM payment order and liquidity transfer order [▶ 213]	Liquidity credit transfer order	Inbound
	Process overnight deposit - setting up order [▶ 275]	Overnight deposit - setting up order	Inbound
	Process overnight deposit - reverse order [▶ 275]	Overnight deposit - reverse order	Inbound
	Process overnight deposit - refund and interest [▶ 276]	Refund of overnight deposits	Outbound
	Process marginal lending on request - setting up order [▶ 278]	Marginal lending on request – setting-up order	Inbound
camt.053 [▶ 511]	Receive CLM report [▶ 302]	Statement of account	Outbound
	Send CLM query [▶ 297]	Query response for business data - account statement query	Outbound
	Send CLM query [▶ 297]	Query response for business data - general ledger [▶ 567] query (CB only)	Outbound
camt.053 [▶ 567] General Ledger [▶ 567]	Receive CLM report [▶ 302]	General ledger [▶ 567] (CB only)	Outbound
camt.054 [▶ 520]	Settle connected payments [▶ 243]	Debit notification	Outbound
	Settle connected payments [▶ 243]	Credit notification	Outbound
	Modify credit line [▶ 247]	Credit line modification notification	Outbound
	Settle standing order in CLM	Debit notification	Outbound

ISO Message	UDFS Chapter	Message Usage	Inbound/Outbound
	[220]		
	Settle standing order in CLM	Credit notification	Outbound
	[220]		
	Perform standard CLM settlement [▶ 223]	Debit notification	Outbound
	Perform standard CLM settlement [▶ 223]	Credit notification	Outbound
camt.056 [▶ 573]	Perform CLM payment order revocation [▶ 216]	Payment order revocation request	Inbound
head.001 [▶ 549]	Send CLM message [▶ 211]	CLM message	Inbound
	Business Application Header [318]	CLM message	Outbound
head.002 [▶ 555]	Send CLM file [▶ 209]	CLM file	Inbound
pacs.002 [▶ 615]	Settle connected payments [243]	Payment order fail notification	Outbound
	Settle connected payments [▶ 243]	Payment order settlement notification	Outbound
	Reject payment order [259]	Payment order rejection notification	Outbound
	Process CLM payment order and liquidity transfer order [213]	Payment order rejection notification	Outbound
	Perform CLM payment order revocation [▶ 216]	Payment order revocation notification	Outbound
	Perform standard CLM settlement [▶ 223]	Payment order settlement notification	Outbound
pacs.009 [▶ 580]	Process CLM payment order and liquidity transfer order [213]	Financial institution credit transfer order	Inbound
pacs.010 [▶ 633]	Process CLM payment order and liquidity transfer order [213]	Financial institution direct debit order	Inbound
camt.998 [▶ 580]	Modify credit line [247]	Credit line modification	Inbound

ISO Message	UDFS Chapter	Message Usage	Inbound/Outbound
ModifyCreditLine [▶ 580]			
camt.998 [▶ 604] InsertBalanceMinimumReserve [▶ 604]	Insert or adjust balance for minimum reserve fulfilment [▶ 287]	Insert or adjust balance for minimum reserve fulfilment order	Inbound
camt.998 [▶ 600] InsertValueOfReserveMinimumReserve [▶ 600]	Maintain minimum reserve requirement order [▶ 285]	Maintain minimum reserve requirement order	Inbound
camt.998 [▶ 584] AuthorizePenaltyMinimumReserve [▶ 584]	Administrate minimum reserve penalty order [▶ 293]	Administrate minimum reserve penalty order	Inbound
camt.998 [▶ 608] ReturnPeriodicInformationMinimumReserve [▶ 608]	Process minimum reserve fulfilment notification [▶ 296]	Minimum reserve fulfilment notification	Outbound
camt.998 [▶ 588] GetPenaltyMinimumReserve [▶ 588]	Send CLM query [▶ 297]	Query request message - penalty query (CB only)	Inbound
camt.998 [▶ 591] ReturnPenaltyMinimumReserve [▶ 591]	Send CLM query [▶ 297]	Query rejection for failed business validation - penalty query (CB only)	Outbound
	Send CLM query [▶ 297]	Query response for business data - penalty query (CB only)	Outbound

Table 95 - Usage of Messages

11.4 Message references

This chapter aims to illustrate the approach for the processing and mapping of reference information in messages used by CLM. References are used with different purposes. In particular they aim to identify single transactions. In addition they can be used to determine a transaction for query status information or to perform actions, e.g. deletion.

In general message identification references can be divided into two categories, i.e.:

- I point-to-point references;
- I end-to-end references.

Point-to-point reference information is used bilaterally between the business sender and CLM respectively CLM and the business receiver of a message. It is per definition unique per business sender for a defined period, i.e. one CLM business day. In general, this means that a point-to-point information is not subject to be transported in the end-to-end communication across the payment chain. Nevertheless, there are some differences in the handling of the point-to-point information. In particular this means that a point-to-point reference can be forwarded changed or newly created by CLM.

- | Business message identifier (used in BAH) is always modified by CLM, i.e. no subject for forwarding. The business message Identifier in the BAH replaces in CLM the message identifier (value "NONREF") in the group header of all messages.
- | Instruction identification is left untouched by CLM, i.e. will be forwarded unchanged in the outbound messages.
- | Clearing System Reference transports the booking reference assigned by CLM.

An end-to-end reference is passed on, unchanged, throughout the entire end-to-end chain. Depending on its nature, it is added either by the initiating party or by CLM.

- | End-to-end identification is assigned by the initiating party and aims to unambiguously identify a transaction.
- | UETR is a universally unique identifier and to be generated by the initiating party of a transaction.

All messages used by CLM are ISO 20022 compliant. That means that in general all elements should be harmonised across the message portfolio and can simply be mapped into equivalent element in other messages, e.g. end-to-end identification. Nevertheless, in some cases the same information is mapped into another element, e.g. the booking reference added by CLM in payment messages in element clearing system reference is mapped in booking notification message ([camt.054](#) [▶ 520]) into element notification entry reference.

The following picture illustrates the processing, forwarding and mapping of point-to-point and end-to-end references by CLM:

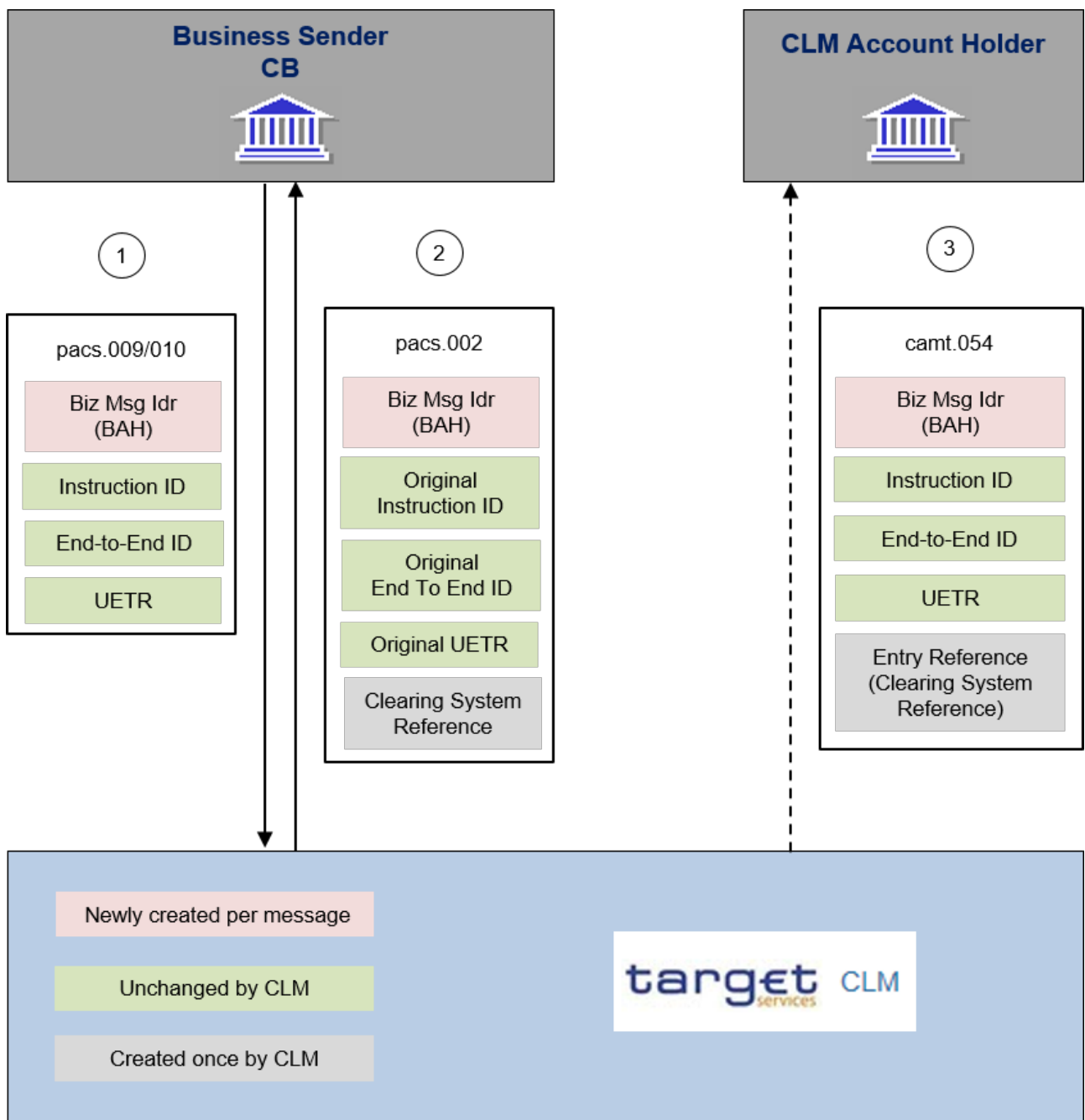

Figure 92 - Message References

The revocation of a payment order in CLM is only possible when all the elements defined in the diagram below can be matched between the revocation message (camt.056) and the message of the payment order to be revoked (pacs.009/010).

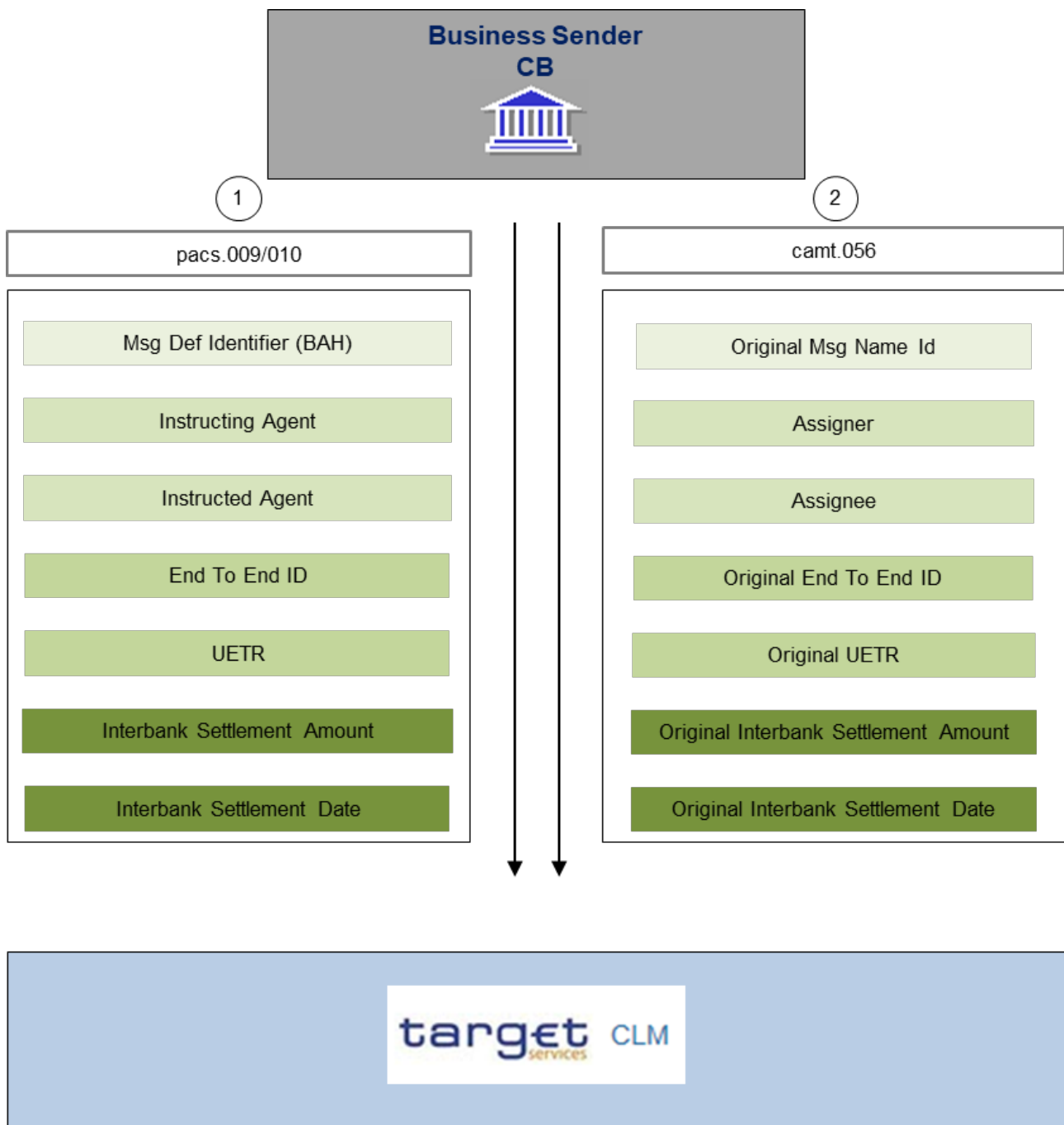

Figure 93 - Linking camt.056 and payment orders

Details for the revocation of payment orders are outlined in chapter [Revocation of payment orders](#) [▶ 106].

11.5 Business scenarios

This chapter provides an overview of business scenarios and system of real BICs set up to bring a message example into context in CLM and into a relation to other message examples. The rationale behind this concept is to clearly show the flow of relevant BICs, account identifications, references, etc. across inbound

and outbound messages within a realistic business scenario. The details of the message examples in the below listed business scenarios are to be found in the sub-chapter “The message in business context” of each message in [List of messages](#) [▶ 364] or [List of messages specific for CBs](#) [▶ 560].

The business scenarios have been laid upon a system of real BICs and the related account identifiers follow a logical structure.

In the following table, the business reader is provided with a list of all BICs and account identifiers found in the CLM business scenarios.

Description of usage	Party BIC	Account BIC	Account identifier
System	TRGTXPML M		
Party (CB)	MARKDEFFXX X		
CLM CB account	MARKDEFFXX X	MARKDEFFXX X	MDEEURMARKDEFFXXXMARKDEFFXXX
Overnight deposit account	MARKDEFFXX X	n/a	DDEEURCOBADEFFXXX0001
Marginal lending account	MARKDEFFXX X	n/a	LDEEURCOBADEFFXXX0001
Party (payment bank #1)	COBADEFFXX X		
CLM MCA (default MCA)	COBADEFFXX X	COBADEFFXX X	MDEEURCOBADEFFXXXCOBADEFFXXX
Party (payment bank #3)	SOLADESTXX X		
CLM MCA (default MCA)	SOLADESTXX X	SOLADESTXX X	MDEEURSOLADESTXXXSOLADESTXXX
Externally held account	n/a	INGBDEFFXX X	
Party (external party)	SOGEFRPPH CM	n/a	
Abstract reference to T2S DCA	n/a	n/a	ERTGSC0DEEUR001
Unknown BIC used in validation failure examples	BSCHARBASS S		

Description of usage	Party BIC	Account BIC	Account identifier
Other mandatory message usages, but not used by CLM			
Debtor	BSCHARBAXX X		
Creditor	INGBBRSPXX X		

Table 96 - Table of BICs and account identifiers

Business scenarios are defined to assist the business reader to implement end-to-end scenarios and are provided for the most frequent and complex business cases in CLM.

In the following table, the business reader is provided with detailed descriptions of the business scenarios and the related message examples for each business scenario:

Business scenario	Overview	Message examples
Scenario 001 – CLM pacs.009 rejection	A pacs.009 payment message is rejected. A pacs.002 status message is used to inform the sender of the rejection.	Inbound_pacs.009_CLM_FICreditTransferOrder_bs001.xml pacs.002_CLM_FIPaymentStatusReport_RJCT_bs001.xml
Scenario 002 – CLM pacs.009 (CONP) settlement	A pacs.009 connected payment message is fully processed and settled. A pacs.002 status message is used to inform the sender of the pacs.009 of the settlement; a camt.054 is used to notify the participant about the credit line update and the connected payment will appear in the camt.053.	Inbound_pacs.009_CLM_FICreditTransferOrder_CONP_bs002.xml pacs.002_CLM_FIPaymentStatusReport_ACSC_bs002.xml camt.054_CLM_CreditNotification_CONP_bs002.xml camt.053_CLM_BankToCustomerStatement_bs999.xml
Scenario 003 – CLM pacs.009 successfully revoked	A pacs.009 payment message is accepted, but before settlement occurs the waiting payment is successfully revoked (cancelled) using a camt.056 message. The sender of the camt.056 will receive a camt.029 informing of the successful cancellation action; the sender of the original	Inbound_pacs.009_CLM_FICreditTransferOrder_bs003.xml Inbound_camt.056_CLM_PaymentCancellationRequest_bs003.xml Outbound_camt.029_CLM_PaymentCancellationRequestStatus_Execution_bs003.xml pacs.002_CLM_FIPaymentStatusReport_RJCT_bs003.xml

Business scenario	Overview	Message examples
	pacs.009 will receive a pacs.002 informing that their cash instruction has been cancelled.	
Scenario 004 – CLM camt.056 for pacs.009 rejected	A pacs.009 payment message is accepted, but before settlement occurs the business sender sends a camt.056 to revoke the waiting payment. The camt.056 is rejected, and the sender receives a camt.029 informing of the rejection. This results in the payment remaining eligible for settlement. Two days later, on the expected settlement date of October, full settlement occurs as originally intended with the resulting pacs.002 and camt.054 responses being sent to the debit and credit account holders respectively.	Inbound_pacs.009_CLM_FICreditTransferOrder_bs004.xml pacs.002_CLM_FIPaymentStatusReport_ACSC_bs004.xml Inbound_camt.056_CLM_PaymentCancellationRequest_bs004.xml Outbound_camt.029_CLM_PaymentCancellationRequestStatus_Rejection_bs004.xml camt.054_CLM_CreditNotification_PMNT_bs004.xml
Scenario 005 – CLM pacs.010 rejection	A pacs.010 direct debit message is rejected and a pacs.002 status message is used to inform the sender of the rejection.	Inbound_pacs.010_CLM_FIDirectDebitOrder_bs005.xml pacs.002_CLM_FIPaymentStatusReport_RJCT_bs005.xml
Scenario 006 – CLM pacs.010 successfully settled	A pacs.010 direct debit message related to a seizure of funds is sent to CLM. A reservation for seizure of funds has been set up in advance and so the direct debit settles immediately (its intended settlement date) In this scenario, neither the CB nor the PB have subscribed to receive pacs.002 or camt.054 messages, so no further messages are created.	Inbound_pacs.010_CLM_FIDirectDebitOrder_bs006.xml

Business scenario	Overview	Message examples
Scenario 007 – CLM camt.056 for pacs.010 rejected	A pacs.010 direct debit message is accepted, but before settlement occurs the business sender sends a camt.056 to revoke the waiting direct debit movement. The camt.056 is rejected and the sender receives a camt.029 informing of the rejection. This results in the direct debit remaining eligible for settlement.	Inbound_pacs.010_CLM_FICreditTransferOrder_bs007.xml Inbound_camt.056_CLM_PaymentCancellationRequest_bs007.xml Outbound_camt.029_CLM_PaymentCancellationRequestStatus_Rejection_bs007.xml
Scenario 008 – CLM head.001 rejection	A pacs.009 message is rejected for being sent on the Real-time network service, instead of the Store-and-Forward network service. An admi.007 is used to advise of the error.	Inbound_head.001_CLM_BAH_(CB-to-CLM)_bs008.xml admi.007_CLM_ReceiptAcknowledgement_Error_bs008.xml
Scenario 009 – CLM head.001 CLM to payment bank	A BAH to be used with a camt.054 from CLM to a payment bank.	Outbound_head.001_CLM_BAH_(CLM-to-PB)_bs009.xml
Scenario 010 – CLM head.001 payment bank to CLM	A BAH to be used with a camt.050 from a payment bank into CLM.	Inbound_head.001_CLM_BAH_(PB-to-CLM)_bs010.xml
Scenario 011 – CLM head.002 rejection	A file is rejected owing to a validation error (duplicate file) in head.002 (BFH). An admi.007 is used to advise of the error.	Inbound_head.002_CLM_BFH_(PB-to-CLM)_bs011.xml admi.007_CLM_ReceiptAcknowledgement_Error_bs011.xml
Scenario 012 – CLM head.002 payment bank to CLM	A file is accepted for further processing owing to a valid head.002 (BFH).	Inbound_head.002_CLM_BFH_(PB-to-CLM)_bs012.xml
Scenario 045 – CLM camt.046 current reservation query returns business data	A camt.046 reservation query is submitted to CLM by an account owner to query the reservations on one of their own CLM accounts and receives a camt.047 response containing an appropriate list of	camt.046_CLM_CurrentReservationsQuery_bs045.xml camt.047_CLM_CurrentReservationsQueryResponse_Data_bs045.xml

Business scenario	Overview	Message examples
	reservations.	
Scenario 046 – CLM camt.046 current reservation query returns business error	A camt.046 reservation query is submitted to CLM to query all the reservations for all accounts owned by a single account owner. However, the noted owner BIC is incorrect and CLM returns a camt.047 error response to the query sender.	camt.046_CLM_CurrentReservationsQuery_bs046.xml camt.047_CLM_CurrentReservationsQueryResponse_Error_bs046.xml
Scenario 047 – CLM camt.048 current reservation modification gets left pending	A valid camt.048 reservation modification is accepted but it is not possible to execute it yet so it is queued for a later execution. A camt.025 status message is used to advise the sender of the camt.048 regarding the queued state.	camt.048_CLM_ModifyCurrentReservation_bs047.xml camt.025_CLM_Receipt_XSTS_PDNG_bs047.xml
Scenario 048 – CLM camt.049 current reservation deletion fails during execution	A valid camt.049 current reservation deletion has been accepted and queued, but has failed during its subsequent execution. A camt.025 status message is used to advise the sender of the camt.049 regarding the failed state.	camt.049_CLM_DeleteCurrentReservation_bs048.xml camt.025_CLM_Receipt_XSTS_ERROR_bs048.xml
Scenario 049 – CLM camt.049 current reservation successfully deleted	A valid camt.049 current reservation deletion has been accepted and successfully executed. A camt.025 status message is used to advise the sender of the camt.049 regarding the successful execution.	camt.049_CLM_DeleteCurrentReservation_bs049.xml camt.025_CLM_Receipt_XSTS_COMP_bs049.xml
Scenario 050 – CLM camt.050 MCA-to-MCA successfully settled	A valid camt.050 moving liquidity from one MCA to another MCA settles successfully in CLM. Although not specified in the camt.050,	camt.050_CLM_LiquidityCreditTransfer_MCAMCA_bs050.xml camt.025_CLM_Receipt_SSTS_bs050.xml camt.054_CLM_CreditNotification_LIQT_bs050.xml

Business scenario	Overview	Message examples
	the instruction was sent and settled on October 8 th . The business sender receives a camt.025 as confirmation and the credited account owner receives a camt.054 notification of credit. Additionally, the debit side will appear in the camt.053 for the debited account.	camt.053_CLM_BankToCustomerStatement_bs999.xml
Scenario 051 – CLM camt.050 MCA-to-DCA rejected	A camt.050 moving liquidity from a CLM MCA to an RTGS DCA is submitted to CLM but fails to pass validation. The business sender receives a camt.025 advising of the failure reason.	camt.050_CLM_LiquidityCreditTransfer_MCADCA_bs051.xml camt.025_CLM_Receipt_VSTS_bs051.xml
Scenario 052 – CLM camt.050 MCA-to-T2S settled	A valid camt.050 moving liquidity from an MCA to a T2S DCA settles successfully in CLM. A camt.025 status message is used to advise the sender of the camt.050 of the settlement. As the response camt.025 is the same as the one in business scenario 050, there is no camt.025 provided in this business scenario.	camt.050_CLM_LiquidityCreditTransfer_MCAT2S_bs052.xml
Scenario 053 – CLM camt.050 overnight deposit settled	A valid camt.050 moving liquidity from an MCA to a CLM overnight deposit account settles successfully in CLM. As the response camt.025 is the same as the one in business scenario 050, there is no camt.025 provided in this business scenario.	camt.050_CLM_LiquidityCreditTransfer_OvernightDeposit_bs053.xml
Scenario 057 – CLM camt.018 request for system time	A camt.018 message is sent to CLM requesting to be informed of the CLM system time. The	camt.018_CLM_CurrentSystemTimeQuery_RT16_bs057.xml camt.019_CLM_CurrentSystemTimeQueryResponse

Business scenario	Overview	Message examples
	valid request is processed and a camt.019 is returned with the requested information.	_RT16_bs057.xml
Scenario 058 – CLM camt.018 request for event status information (Business day with optional maintenance window)	A camt.018 message is sent to CLM requesting to be informed of the status of all events in CLM. The message is sent on a day when the system schedule contains an Optional Maintenance Window. The valid request is processed and a camt.019 is returned with the appropriate Optional Maintenance Window information.	camt.018_CLM_CurrentEventQuery_bs058.xml camt.019_CLM_CurrentEventQueryResponse_Data_bs058.xml
Scenario 059 – CLM system-generated camt.019	A camt.019 message has been automatically generated by CLM and sent to a business receiver, notifying the business receiver of a CLM event, which has just reached its execution time.	camt.019_CLM_CurrentEventNotification_CSOD_bs059.xml
Scenario 064 – CLM credit line replacement	A CB send a camt.998-ModifyCreditLine message to request a credit line value of EUR 7.5 million to be applied to the default MCA of an account holder. For this scenario it is stated that the current credit line value is EUR 7 million. The valid request is applied to the system and is actioned successfully. CLM sends a 'completed' status camt.025 to the requesting CB and a camt.054 notification to the MCA owner. It should be noted that the camt.054 will always indicate	camt.998_CLM_ModifyCreditLine_RPLC_bs064.xml camt.025_CLM_Receipt_XSTS_COMP_bs064.xml camt.054_CLM_CreditLineModificationNotification_bs064.xml

Business scenario	Overview	Message examples
	<p>the change to the credit line value (a so-called 'delta' value), irrespective of the fact that this business scenario will have used an absolute replacement credit line value.</p>	
Scenario 065 – CLM credit line increase	<p>A CB sends a camt.998-ModifyCreditLine message to request a credit line increase of EUR 0.5 million, to be applied to the default MCA of an account holder. For this scenario it is stated that the current credit line value is EUR 7 million.</p> <p>The valid request is applied to the system and is actioned successfully. CLM sends a 'completed' status camt.025 to the requesting CB and a camt.054 notification to the MCA owner.</p>	<p>camt.998_CLM_ModifyCreditLine_INCR_bs065.xml camt.025_CLM_Receipt_XSTS_COMP_bs065.xml camt.054_CLM_CreditLineModificationNotification_bs065.xml</p>
Scenario 066 – CLM - admi.005 General ledger query	<p>The general ledger, which is held on CLM is subsequently requested for additional sending via an admi.005 query.</p>	<p>admi.005_CLM_ReportQueryRequest_bs066.xml</p>
Scenario 068 – CLM standing order for billing settles	<p>A direct debit is executed in CLM in settlement of a previously indicated billing invoice and settles successfully. In CLM there is no payment chain, so the debited party receives a camt.054 notification of the debit.</p>	<p>camt.054_CLM_DebitNotification_Billing_bs068.xml</p>
Scenario 070 – CLM camt.050 MCA-to-DCA successfully settled	<p>Valid camt.050 moving liquidity from a CLM MCA to an RTGS DCA settles successfully. CLM sends a Receipt (camt.025) to inform of the settlement to the</p>	<p>camt.050_CLM_LiquidityCreditTransfer_MCADCA_bs070.xml camt.025_CLM_Receipt_SSTS_SSET_bs070.xml camt.054_RTGS_CreditNotification_LIQT_bs070.xml</p>

Business scenario	Overview	Message examples
	<p>sender of the camt.050 instruction. As a result of the internal processing between CLM and RTGS, RTGS sends a credit notification (camt.054) to the owner of the credited account.</p>	
<p>Scenario 071 – CLM camt.018 request for event status information (Business day with non-optional maintenance window)</p>	<p>Camt.018 message is sent into CLM requesting to be informed of the status of all Events in the CLM system. The message is sent on a day when the system schedule contains a non-optional Maintenance Window. The valid request is processed and a camt.019 is returned with the appropriate non-optional Maintenance Window information.</p>	<p>camt.018_CLM_CurrentEventQuery_bs071.xml camt.019_CLM_CurrentEventQueryResponse_Data_bs071.xml</p>
<p>Scenario 073 – CLM automatic marginal lending</p>	<p>During CLM end of day processing, a PB has a negative overall balance and CLM invokes automatic marginal lending. In this scenario, it is accepted that the CB and PB are fully subscribed to all notification messages.</p> <p>CLM generates an internal connected payment which it successfully settles, including a simultaneous reduction in the credit line. CLM then uses camt.054 messages to inform the CB of the amount debited from the marginal lending account (before ECMS) and to inform the PB of the amount credited to the PB's MCA (and the respective reduction in credit</p>	<p>camt.054_CLM_CreditNotification_AMLS_bs073.xml camt.054_CLM_DebitNotification_AMLS_bs073.xml camt.054_CLM_DebitNotification_AMLR_bs073.xml camt.054_CLM_CreditNotification_AMLR_bs073.xml camt.054_CLM_DebitNotification_MLIN_bs073.xml camt.054_CLM_CreditNotification_MLIN_bs073.xml</p>

Business scenario	Overview	Message examples
	<p>line).</p> <p>During start of day processing of the next business day, CLM generates an internal reversing connected payment which it successfully settles, including a simultaneous increase in the credit line. CLM then uses camt.054 messages to inform the CB of the amount credited to the marginal lending account and to inform the PB of the amount debited from the PB's MCA (and the respective increase in credit line).</p> <p>Finally, CLM calculates and moves the marginal lending interest amount from the PB's default MCA to the CLM CB account. CLM then uses camt.054 messages to inform the CB and PB of this interest payment.</p>	
<p>Scenario 074 – CLM spillover notification (camt.004) to CB</p>	<p>During CLM end of day processing, a PB has a negative overall balance but CLM cannot invoke marginal lending because the PB has insufficient permission for the facility. In this case, CLM alerts the responsible central bank to the situation using a camt.004 message in 'spillover' mode.</p> <p>It should be noted that the camt.004 is an alert regarding the funding situation of the PB and does not make any reference to particular payment/s which may have</p>	<p>camt.004_CLM_ReturnAccount_Spillover_bs074.xml</p>

Business scenario	Overview	Message examples
	caused the situation.	
Scenario 077 – Delta set query	<p>During a processing day, 4 payment orders are variously entered into CLM (payment order message examples not provided here). During the same day, the authorized party BIC SOLADESTXXX uses a delta set to achieve hourly activity reports starting at 09:00, and ending at 12:00.</p> <p>Time line overview:</p> <p>Before 09:00, two payment orders (called B and D) are entered and queued.</p> <p>At 09:00 an initiating query returns details for payment orders B and D shows them as queued, and also returns a reference for the delta set.</p> <p>Before 10:00, 2 more payment orders (called A and C) are entered and queued.</p> <p>At 10:00, the returned delta set reference is used for a delta query request, which returns details showing payment orders A and C as queued. Payment orders B and D are still queued but do not appear on the delta report as they have not changed since the previous query (at 09:00).</p> <p>Before 11:00, payment order B reaches settlement and payment order C is revoked.</p> <p>At 11:00, the returned delta set reference is used for a delta</p>	<p>camt.005_CLM_GetTransation_INIT_bs077.xml</p> <p>camt.006_CLM_ReturnTransaction_INIT_bs077.xml</p> <p>camt.005_CLM_GetTransaction_DLT1_bs077.xml</p> <p>camt.006_CLM_ReturnTransaction_DLT1_bs077.xml</p> <p> </p> <p>camt.005_CLM_GetTransaction_DLT2_bs077.xml</p> <p>camt.006_CLM_ReturnTransaction_DLT2_bs077.xml</p> <p> </p> <p>camt.005_CLM_GetTransaction_DLT3_bs077.xml</p> <p>camt.006_CLM_ReturnTransaction_DLT3_bs077.xml</p> <p> </p>

Business scenario	Overview	Message examples
	<p>query request, which returns details showing payment order B as settled and C as cancelled. Payment orders A and D are still queued but do not appear on the delta report as they have not changed since the previous query (at 10:00).</p> <p>Before 12:00, payment order A reaches settlement and payment order D is rejected.</p> <p>At 12:00, the returned delta set reference is used for a delta query request, which returns details showing payment order A as settled and D as rejected. Payment orders B and C are still settled and cancelled respectively but do not appear on the delta report as they have not changed since the previous query (at 11:00).</p>	
<p>Scenario 079 – CLM payment reject time broadcast</p>	<p>A pacs.009 payment order message was validated by CLM and queued for execution within the settlement time request given on the payment order. 15 minutes before the indicated reject time in the payment order CLM sends an admi.004 system event notification message to notify the sender of the pacs.009 about the possible rejection.</p> <p>Note: to avoid an excess number of example payment messages, the pacs.009 is not available, but is assumed to be of a basic data population with</p>	<p>Inbound_pacs.009_CLM_FICreditTransferOrder_bs079.xml (not available)</p> <p>admi.004_CLM_SystemEventNotification_RJCT_bs079.xml</p>

Business scenario	Overview	Message examples
	defined reject time and appropriate references for this scenario.	
Scenario 080 – CLM operations related broadcast	During the processing day, a problem occurred whereby a CLM Party had to be blocked. The Operator used CLM to send an admi.004 system event notification message to notify relevant parties of the blocking.	admi.004_CLM_SystemEventNotification_FREE_bs080.xml
Scenario 084 – CLM threshold breaches	During the processing day, settlement of payment orders and liquidity transfers alters some account balances in a way which takes them either over the ceiling threshold for the account, or under the floor threshold. CLM tracks such threshold breaches and sends notifications to the account holders when it occurs. In this business scenario, CLM has detected 2 such breaches during business scenario bs050.	camt.004_CLM_ReturnAccount_FLOR_bs084.xml camt.004_CLM_ReturnAccount_CEIL_bs084.xml
Scenario 100 – CLM Get Account	A camt.003 account query message is sent to CLM on 8 th October 2019, at 15:00, requesting the balance information of a single indicated CLM cash account. The valid request is processed and a camt.004 returned with the requested information.	camt.003_CLM_AccountQuery_bs100.xml camt.004_CLM_ReturnAccount_bs100.xml
Scenario 101 – CLM Get Account with error	A camt.003 account query message is sent to CLM on 8 th October 2019, at 15:00, requesting the balance information of a single indicated	camt.003_CLM_AccountQuery_bs101.xml camt.004_CLM_ReturnAccount_bs101.xml

Business scenario	Overview	Message examples
	CLM cash account. The request fails validation and a camt.004 is returned with the error information	
Scenario 102 - Account holder requesting all transactions	An account holder sends a transaction query (camt.005) to CLM requesting details of all transactions for the current day against all its accounts. The list of accounts is limited by the data-scope of the sending account holder and the list of required data fields is explicitly indicated in the query message. CLM returns a camt.006 with the requested information.	camt.005_CLM_GetTransaction_bs102.xml camt.006_CLM_ReturnTransaction_bs102.xml
Scenario 103 – Request for transactions with error response	A camt.005 transaction query message is sent to CLM requesting information for all transactions which required to settle on a particular account. The request fails validation against the business rules and is rejected. CLM returns a camt.006 with details of the validation error.	camt.005_CLM_GetTransaction_bs103.xml camt.006_CLM_ReturnTransaction_bs103.xml
Scenario 104 – CLM camt.003 minimum reserve fulfilment query by a CB, with data response	A camt.003 account query message is sent to CLM by a CB requesting minimum reserve fulfilment information for a specified lead account holder. The valid request is processed and a camt.004 is returned with the requested information.	camt.003_CLM_AccountQuery_bs104.xml camt.004_CLM_ReturnAccount_bs104.xml
Scenario 105 – CLM camt.003 minimum reserve fulfilment query by a non-lead participant, with data response	A camt.003 account query message is sent to CLM by a participant (not a lead account holder) requesting minimum	camt.003_CLM_AccountQuery_bs105.xml camt.004_CLM_ReturnAccount_bs105.xml

Business scenario	Overview	Message examples
	<p>reserve fulfilment information for a specified account. The valid request is processed and a camt.004 is returned with the requested information.</p>	
<p>Scenario 106 – Account holder requesting a single transaction</p>	<p>An account owner sends a transaction query (camt.005) for a single transaction which the sender identifies using a unique reference. The list of required data fields is very small since the transaction data is already known to the sender. CLM returns a camt.006 with the requested information.</p>	<p>camt.005_CLM_GetTransaction_bs106.xml camt.006_CLM_ReturnTransaction_bs106.xml</p>
<p>Scenario 107 – CB requesting all transactions</p>	<p>A CB sends a transaction query (camt.005) – which is identical to the query used in bs102 -to CLM requesting details of all transactions for the current day against all accounts in its community. The list of accounts is limited by the data-scope of the sending CB and the list of required data fields is explicitly indicated in the query message. CLM returns a camt.006 with the requested information.</p>	<p>camt.005_CLM_GetTransaction_bs107.xml camt.006_CLM_ReturnTransaction_bs107.xml</p>
<p>Scenario 108 - A CB requesting a single transaction with all fields</p>	<p>A CB sends a transaction query (camt.005) for a single transaction which the sender identifies using a unique reference. The query criteria is identical to the query in bs106, but there is no list of required fields provided. CLM returns a camt.006 with the requested information.</p>	<p>camt.005_CLM_GetTransaction_bs108.xml camt.006_CLM_ReturnTransaction_bs108.xml</p>

Business scenario	Overview	Message examples
Scenario 109 – CB requesting marginal lending accounts	A CB sends a transaction query (camt.005) requesting a small amount of information for all transactions on one of its marginal lending accounts. CLM returns a camt.006 with the requested information.	camt.005_CLM_GetTransaction_bs109.xml camt.006_CLM_ReturnTransaction_bs109.xml
Scenario 141 – CLM camt.998 (GetPenalty) query with data response	A central bank sends a Get Penalty (camt.998-GetPenaltyMinimumReserve) message to query minimum reserve penalties within its entire community, for all penalty status values. CLM responds by sending a ReturnPenalty (camt.998-ReturnPenaltyMinimumReserve) message containing the resulting data. To make sense of the response, the query is presumed to be submitted by CB (BIC: MARKDEFFXXX) after 09:00 on 23-March-2020.	camt.998_CLM_GetPenaltyMinimumReserve_bs141.xml camt.998_CLM_ReturnPenaltyMinimumReserve_bs141.xml
Scenario 142 – CLM camt.998 (GetPenalty) query with error response	A central bank sends a Get Penalty (camt.998-GetPenaltyMinimumReserve) message to query minimum reserve penalties for a particular payment bank, for all penalty status values. CLM fails the query against the validation rules and then responds by sending a ReturnPenalty (camt.998-ReturnPenaltyMinimumReserve) message containing details of the validation error.	camt.998_CLM_GetPenaltyMinimumReserve_bs142.xml camt.998_CLM_ReturnPenaltyMinimumReserve_bs142.xml

Business scenario	Overview	Message examples
	To make sense of the response, the query is presumed to be submitted by CB (BIC: MARKDEFFXXX) after 09:00 on 23-March-2020.	
Scenario 143 – CLM camt.998 (AuthorisePenalty) is successful	A central bank sends an Authorise Penalty (camt.998- AuthorizePenaltyMinimumReserve) message to CLM in respect of authorising an existing waiting penalty. CLM responds by sending a Receipt (camt.025) message indicating that the authorisation was successful.	camt.998_CLM_AuthorisePenaltyMinimumReserve_bs143.xml camt.025_CLM_Receipt_XSTS_COMP_bs143.xml
Scenario 144 – CLM camt.998 (AuthorisePenalty) fails	A central bank sends an Authorise Penalty (camt.998- AuthorizePenaltyMinimumReserve) message to CLM in respect of authorising an existing waiting penalty. CLM fails the authorisation message against the validation rules and responds by sending a Receipt (camt.025) message indicating why authorisation request was invalid.	camt.998_CLM_AuthorisePenaltyMinimumReserve_bs144.xml camt.025_CLM_Receipt_VSTS_bs144.xml
Scenario 147 – CLM camt.998 (InsertValue) is successful	A central bank sends an Insert Value (camt.998- InsertvalueOfMinimumReserve) message to CLM in respect of applying a new minimum reserve requirement to one of its payment banks. CLM responds by sending a Receipt (camt.025) message indicating that the new value was successfully inserted.	camt.998_CLM_InsertValueOfMinimumReserve_bs147.xml camt.025_CLM_Receipt_XSTS_COMP_bs147.xml
Scenario 148 – CLM camt.998 (InsertValue) fails	A central bank sends an Insert Value (camt.998-	camt.998_CLM_InsertValueOfMinimumReserve_bs148.xml

Business scenario	Overview	Message examples
	<p>InsertvalueOfMinimumReserve) message to CLM in respect of applying a new minimum reserve requirement to one of its payment banks. CLM fails the insert value message against the validation rules and responds by sending a Receipt (camt.025) message indicating why insert value request was invalid.</p>	<p>camt.025_CLM_Receipt_VSTS_bs148.xml</p>
<p>Scenario 149 – CLM camt.998 (InsertBalance) is successful</p>	<p>A central bank sends an Insert Balance (camt.998-InsertBalanceMinimumReserve) message to CLM in respect of recording external account balances for one of its payment banks. CLM responds by sending a Receipt (camt.025) message indicating that the new balance was successfully inserted.</p>	<p>camt.998_CLM_InsertBalanceMinimumReserve_bs149.xml camt.025_CLM_Receipt_XSTS_COMP_bs149.xml</p>
<p>Scenario 150 – CLM camt.998 (InsertBalance) fails</p>	<p>A central bank sends an Insert Balance (camt.998-InsertBalanceMinimumReserve) message to CLM in respect of recording external account balances for one of its payment banks. CLM fails the insert balance message against the validation rules and responds by sending a Receipt (camt.025) message indicating why insert balance request was invalid.</p> <p>To make sense of the response, the query is presumed to be submitted by CB (BIC: MARKDEFFXXX) on business</p>	<p>camt.998_CLM_InsertBalanceMinimumReserve_bs150.xml camt.025_CLM_Receipt_VSTS_bs150.xml</p>

Business scenario	Overview	Message examples
	date of 23-March-2020.	
Scenario 151 – CLM camt.998 (ReturnPeriodicInformation) is sent to a central bank	<p>Based upon the prescribed schedule, CLM sends a Periodic Information (camt.998-ReturnPeriodicInformationMinimum Reserve) message to a central bank giving current information relating to minimum reserve.</p> <p>To make sense of the data, the message is sent a few days after the start of the current maintenance period. The receiving CB (BIC: MARKDEFFXXX) has 2 payment banks both of which have incurred Interest payments but only one has incurred Penalties.</p>	camt.998_CLM_ReturnPeriodicInformationMinimum Reserve_bs151.xml
Scenario 901 – Full inbound message (BAH + pacs.009)	A pacs.009 payment message is sent into CLM with its associated BAH. This scenario includes no further processing, as it is designed only to provide an example of a full inbound payment message transmission.	<p>Full-Inmessage_CLM_full-head.001 pacs.009_bs901.xml</p> <p>Note: this example is an attachment to the head.001 Usage Guideline in MyStandards</p>
Scenario 902 – Full outbound message (BAH + camt.054)	<p>A camt.054 message is sent from CLM with its associated BAH. It is being sent to the owner of an MCA which has just received a credit of liquidity.</p> <p>This scenario includes no other processing, as it is designed only to provide an example of a full outbound message transmission.</p>	<p>Full-Outmessage_CLM_full-head.001_camt.054_bs902.xml</p> <p>Note: this example is an attachment to the head.001 Usage Guideline in MyStandards</p>
Scenario 903 – Full inbound file (BFH + 2x(BAH + pacs.009))	An inbound file containing 2 pacs.009 payment messages is	Full-Infile_CLM_full-head.002_2xpacs.009_bs903.xml

Business scenario	Overview	Message examples
	sent to CLM. This scenario includes no further processing, as it is designed only to provide an example of a full inbound file transmission	Note: this example is an attachment to the head.002 Usage Guideline in MyStandards
Scenario 999 – CLM camt.053 Customer statement	<p>A camt.053 customer statement is produced by CLM at EoD for each so-configured account in the system and sent to appropriate recipients based upon subscription and routing.</p> <p>In particular, this statement is for a CLM Account (ID: "MDEEURSOLADESTXXXSOLADESTXXX") dated 8 October 2019 and includes a camt.050 and a pacs.009 entry on that date. The opening balance shows as zero for convenience but the closing balance is calculated according to the entries listed.</p> <p>The statement which is retained on CLM is subsequently requested for additional sending via an adm.005 query.</p>	<p>camt.053_CLM_BankToCustomerStatement_bs999.xml</p> <p>admi.005_CLM_ReportQueryRequest_bs999.xml</p>
General ledger example – ECB CLM	In this usage case, CLM delivers a camt.053 general ledger file to the ECB for CLM accounting and reserve management purposes.	camt.053_CLM_BankToCustomerStatement_ECB_GeneralLedger_Example.xml
General ledger example – CB CLM	In this usage case, CLM delivers a camt.053 general ledger file to the CBs for CLM accounting and reserve management purposes. The CBs are being informed of all movements occurring on	camt.053_CLM_BankToCustomerStatement_CB_GeneralLedger_Example.xml

Business scenario	Overview	Message examples
	<p>general ledger accounts in their data scope. This report message is automatically generated by CLM in accordance with the reporting configuration settings applied by the CBs.</p>	
<p>General ledger example – ECB RTGS</p>	<p>In this usage case, CLM delivers a camt.053 general ledger file to the ECB for RTGS accounting and reserve management purposes.</p>	<p>camt.053_RTGS_BankToCustomerStatement_ECB_GeneralLedger_Example.xml</p>

Business scenario	Overview	Message examples
General ledger example – CB RTGS	In this usage case, CLM delivers a camt.053 general ledger file to the CBs for RTGS accounting and reserve management purposes. The CBs are being informed of all movements occurring on general ledger accounts in their data scope. This report message is automatically generated by CLM in accordance with the reporting configuration settings applied by the CBs.	camt.053_RTGS_BankToCustomerStatement_CB_GeneralLedger_Example.xml
General ledger example – ECB TIPS	In this usage case, CLM delivers a camt.053 general ledger file to the ECB for TIPS accounting and reserve management purposes.	camt.053_TIPS_BankToCustomerStatement_ECB_GeneralLedger_Example.xml
General ledger example – CB TIPS	In this usage case, CLM delivers a camt.053 general ledger file to the CBs for TIPS accounting and reserve management purposes. The CBs are being informed of all movements occurring on general ledger accounts in their data scope. This report message is automatically generated by CLM in accordance with the reporting configuration settings applied by the CBs.	camt.053_TIPS_BankToCustomerStatement_CB_GeneralLedger_Example.xml

Table 97 - Table of business scenarios

11.6 Delta Set Retrieval Functionality

11.6.1 Overview

New and changed items can be requested within a delta set query referring to a previously sent delta set initialisation query and its defined search and return criteria. The query response will contain new items and items with changed status.

Modifications of settlement priority or requested execution time do not represent a change of a cash transfer status and will therefore not be reported in delta set query responses.

A set of delta set queries with defined search and return criteria are linked by the query name (message element [`<QryNm>`]) which is assigned by CLM in response on the delta set initialisation query.

- I **New** cash transfers or cash transfer orders in CLM since the last delta set query with the same query name are included in the delta set query response message.
- I **Changed** cash transfer orders, which have already been reported in response of a previous delta set (initialisation) query can be included in another delta set query response in case the cash transfer status has changed in the meantime compared to the previous delta set query response. This includes cash transfer orders where the status changed from an intermediate to another intermediate or to a final status (i.e. settled, rejected or revoked). Cash transfers with a final status are reported only once since a final status does not change any more.
- I There is no further distinction between new items and changed items (with a changed status) in the delta set query response.

Note: Each change of cash transfer status (see CLM UDFS [Cash transfer status](#) [▶ 155]) is provided as part of delta set after the change of the cash transfer status has taken place.

11.6.2 Initialisation of the delta set query and subsequent delta reports

The initialisation query for the delta set retrieval functionality requires its indication by using code word « INIT » in element `<RequestType>` and the requested search and return criteria.

Within the delta set initialisation query response, the user receives an identifier provided in element `<QueryName>`. The query name serves as an identifier for subsequent delta set queries. Once a delta set is initialised, the subsequent modification of search and return criteria for the delta set query is not possible. For this purpose a new delta set initialisation query needs to be sent to CLM.

The query name needs to be provided in element `<QueryName>` in the delta report requests following the delta set initialisation query. No additional entries in `<SearchCriteria>` are considered in these subsequent delta report queries.

There is no limit regarding the number of delta set queries during a business day. With the start of a new business day the business sender needs to initialise new delta set queries because CLM deletes the delta set queries during the end-of-day processing.

Sequence of activities

Step 1 –delta set initialisation query:

The provisioning of a delta set retrieval functionality requires a delta set initialisation query. A delta set initialisation query request is flagged with code “INIT” in element <RequestType>. If this code is not used in the [camt.005 Get Transaction](#) [▶ 411] message, the query is not considered as a delta set initialisation query and thus not stored in CLM for subsequent delta set queries. The code word “INIT” triggers the generation of a query name which is provided in element <QueryName> of related delta set initialisation query response.

The delta set initialisation query also provides the search and return criteria to be applied on all subsequent delta set queries. In case no search and return criteria are provided in the delta set initialisation query the subsequent delta set query responses will consider full data scope of the business sender and will return all available information for each returned item.

All cash transfers to be reported based on the specified search criteria and their status are stored in CLM at the time of the delta set initialisation query. The stored cash transfer status serves as basis for comparison with updated cash transfer status at the time of a newly received delta set query.

Step 2 –delta set initialisation query response:

CLM sends a delta set initialisation query response [camt.006 ReturnTransaction](#) [▶ 434] with a query name in element <QueryName>. This query name is the identifier to the stated cash transfer search criteria. The query name remains the same for all related delta set query responses. Each subsequent request that refers to this query name invokes at CLM a delta set query based on the stored search criteria.

Step 3 –delta set query:

One or several delta set query request(s) is/are sent by the same user sending a [camt.005 GetTransaction](#) [▶ 411] with the relevant query name in element <QueryName>.

Examples:

Scenario	Response to delta set initialisation query	Response to delta set query n	Response to delta set query n+1	Response to delta set query n+2
Cash transfer order A has been submitted between the delta set initialisation query and the delta set query n. A has been queued and settled between delta set query n+1 and delta set query n+2	---	A (as new item with cash transfer status queued)	---	A (due to change of cash transfer status from queued to settled)
Cash transfer order B has been included in the delta set initialisation query response. B has been queued. The settlement takes place between delta set query n and delta set query n+1.	B (with cash transfer status queued)	---	B (due to change of cash transfer status from queued to settled)	---
Cash transfer order C is submitted between the delta set initialisation query response and the delta set query n. C has been queued and revoked between the delta set query response n and the delta set query n+1.	---	C (as new item with cash transfer status queued)	C (due to change of cash transfer status from queued to revoked)	---
Cash transfer order D is reported in the delta set initialisation query response. D has been queued and is rejected between the delta set query response n+1 and the delta set query n+2.	D (with cash transfer status queued)	---	---	D (due to change of cash transfer status from queued to rejected)

Table 98 - Delta query cash transfer scenarios

11.6.3 Full scenario example for delta set query

Overview

During a processing day, 4 payment orders are variously entered into CLM (payment order message examples not provided here). During the same day, a party with authority for MCA “MDEURSOLADESTXXXSOLADESTXXX” uses a delta set to achieve hourly activity reports starting at 09:00, and ending at 12:00.

This scenario describes the payment order activity, but only contains actual example messages for the [camt.005](#) [▶ 411] and [camt.006](#) [▶ 434] (query & response) messages.

Business requirement

The scenario defines a base report criteria set and a schedule of deltas

Time	Action	Query criteria
09:00	Execute query and initiate delta set	Select all transactions for MCA "MDEEURSOLADESTXXXSOLADESTXXX" Show data attributes: Payment status, Interbank settlement amount and End-to-End Id
10:00	Execute a delta of the above criteria	<i>Delta will use above criteria</i>
11:00	Execute a delta of the above criteria	<i>Delta will use above criteria</i>
12:00	Execute a delta of the above criteria	<i>Delta will use above criteria</i>

Table 99 - Delta query business scenario query schedule

DataTransactions used in this scenario:

Payment order	Payment Type	Interbank settlement amount	Credit or Debit Entry	End-to-end Id
A	pacs.009 [624]	EUR 1000	Credit	Inp009b077A-BAH
B	pacs.009 [624]	EUR 2000	Credit	Inp009b077B-BAH
C	pacs.009 [624]	EUR 3000	Debit	Inp009b077C-BAH
D	pacs.009 [624]	EUR 4000	Debit	Inp009b077D-BAH

Table 100 - Delta query business scenario cash transfers

Scenario timeline

The presence of data on each report is totally dependent upon the time at which certain activity occurred.

time	Payment orders				Query/Response
	A	B	C	D	
07:20		Queued			
08:45				Queued	
09:00					A camt.005 [411] query (with QueryType of "INIT") is sent to initialise the delta set with the search and return criteria required (above) Example:

Payment orders					Query/Response
time	A	B	C	D	
					<p>camt.005_CLM_GetTransaction_INIT_bs077.xml</p> <p>A camt.006 [434] response is received from CLM with:</p> <ul style="list-style-type: none"> a delta set reference of "CLMDELTA-b077" - Payment B is shown with a pending status "PSTL" Payment D is shown with a pending status "PSTL" <p>Example: camt.006_CLM_ReturnTransaction_INIT_bs077.xml</p>
09:10	Queued				
09:11			Queued		
10:00					<p>A camt.005 [411] query (with QueryName of "CLMDELTA-b077") is sent to retrieve a delta report</p> <p>Example: camt.005_CLM_GetTransaction_DLT1_bs077.xml</p> <p>A camt.006 [434] response is received from CLM with:</p> <ul style="list-style-type: none"> a delta set reference of "CLMDELTA-b077" Payment A is shown with a pending status "PSTL" Payment C is shown with a pending status "PSTL" Payments B and D are still pending, but are not shown because their status has not changed since the previous query (the INIT at 09:00) <p>Example: camt.006_CLM_ReturnTransaction_DLT1_bs077.xml</p>
10:15		Settled			

Fehler! Verwenden Sie die Registerkarte 'Start', um dem Text zuzuweisen,

time	Payment orders				Query/Response
	A	B	C	D	
10:50			Revoked		
11:00					<p>A camt.005 [▶ 411] query (with QueryName of "CLMDELTA-b077") is sent to retrieve a delta report</p> <p>Example: camt.005_CLM_GetTransaction_DLT2_bs077.xml</p> <p>A camt.006 [▶ 434] response is received from CLM with:</p> <ul style="list-style-type: none"> a delta set reference of "CLMDELTA-b077" Payment B is shown with a settled status "STLD" Payment C is shown with a cancelled status "CAND" Payments A and D are still pending, but are not shown because their status has not changed since the previous query (the delta at 10:00) <p>Example: camt.006_CLM_ReturnTransaction_DLT2_bs077.xml</p>

time	Payment orders				Query/Response
	A	B	C	D	
11:25	Settled				
11:35				Rejected	
12:00					<p>A camt.005 [411] query (with QueryName of "CLMDELTA-b077") is sent to retrieve a delta report</p> <p>Example: camt.005_CLM_GetTransaction_DLT3_bs077.xml</p> <p>A camt.006 [434] response is received from CLM with:</p> <ul style="list-style-type: none"> a delta set reference of "CLMDELTA-b077" Payment A is shown with a settled status "STLD" Payment D is shown with a rejected status "RJTD" Payments B and C were already settled respectively cancelled and therefore not shown because they were already reported with final status in a previous query (the delta at 11:00) <p>Example: camt.006_CLM_ReturnTransaction_DLT3_bs077.xml</p>

Table 101 - Delta query business scenario timeline

12 List of messages

Chapter	Message code	Message name
Administration (admi)		
SystemEventNotification (admi.004) [365]	admi.004	SystemEventNotification
ReportQueryRequest (admi.005) [368]	admi.005	ReportQueryRequest
ReceiptAcknowledgement (admi.007) [370]	admi.007	ReceiptAcknowledgement
Cash Management (camt)		
GetAccount (camt.003) [374]	camt.003	GetAccount
ReturnAccount (camt.004) [380]	camt.004	ReturnAccount
GetTransaction (camt.005) [411]	camt.005	GetTransaction
ReturnTransaction (camt.006) [434]	camt.006	ReturnTransaction
GetBusinessDayInformation (camt.018) [466]	camt.018	GetBusinessDayInformation
ReturnBusinessDayInformation (camt.019) [469]	camt.019	ReturnBusinessDayInformation
Receipt (camt.025) [479]	camt.025	Receipt
GetReservation (camt.046) [492]	camt.046	GetReservation
ReturnReservation (camt.047) [495]	camt.047	ReturnReservation
ModifyReservation (camt.048) [499]	camt.048	ModifyReservation
DeleteReservation (camt.049) [502]	camt.049	DeleteReservation
LiquidityCreditTransfer (camt.050) [505]	camt.050	LiquidityCreditTransfer
BankToCustomerStatement (camt.053) [511]	camt.053	BankToCustomerStatement
BankToCustomerDebitCreditNotification (camt.054) [520]	camt.054	BankToCustomerDebitCreditNotification

Chapter	Message code	Message name
Headers (head)		
BusinessApplicationHeader (head.001) [▶ 549]	head.001	BusinessApplicationHeader
BusinessFileHeader (head.002) [▶ 555]	head.002	BusinessFileHeader

Table 102 - List of messages

12.1 Administration (admi)

12.1.1 SystemEventNotification (admi.004)

12.1.1.1 Overview and scope of the message

This chapter illustrates the *SystemEventNotification* message.

The *SystemEventNotification* message is sent by CLM to one or more business receivers. It is used to provide information in regards to a certain event which has occurred, or been reached, on CLM.

The concept of a 'certain event' could be various things, for example: an expected time-point (e.g. a reject time) is reached; a defined failure scenario is encountered; the operator interrupts normal processing for a given reason.

A single *SystemEventNotification* message only refers to a single event.

The *SystemEventNotification* message is sent only to business receivers who have subscribed to receive such broadcasts.

The usage of this message is to be found in chapter [Usage of Messages](#) [▶ 324].

The *SystemEventNotification* message is sent in response to an operational event within CLM. It is a stand-alone message which has no affiliated trigger or response message.

12.1.1.2 Schema

Outline of the schema

The *SystemEventNotification* message is composed of the following message building blocks.

Event information

This building block is mandatory and non-repetitive. It contains a code for the event, plus some optional further descriptive information (parameter/s, description, timestamp) depending upon what kind of event is being broadcast.

References/links

The CLM-specific schema and documentation in XSD/Excel/PDF format as well as the message examples are provided outside of this document under the following link:

http://www.swift.com/mystandards/CLM/admi.004.001.02_CLM

Business rules applicable to the schema

No business rules are applicable to a *SystemEventNotification* message.

12.1.1.3 The message in business context

Specific message contents

Message item	Utilisation
Event Code Document/SysEvtNtfctn/EvtInf/EvtCd	Broadcast type: <ul style="list-style-type: none"> REJT (Reject), FREE (Free).
Event Parameter Document/SysEvtNtfctn/EvtInf/EvtParam	Parameters for event code REJT: <ul style="list-style-type: none"> parameter 1: account identification of the debit account, parameter 2: original settlement priority.
Event Description Document/SysEvtNtfctn/EvtInf/EvtDesc	Event description for event code FREE: <ul style="list-style-type: none"> General business information summarizing the topic and intended destination of the information in unstructured form. Event description for event code REJT: <ul style="list-style-type: none"> Original UETR
Event Time Document/SysEvtNtfctn/EvtInf/EvtTm	Date and time at which the event occurred.

Table 103 - SystemEventNotification (admi.004)

Usage case: CLM Payment reject time broadcast (Scenario 079)

In this example, CLM is notifying the receiver by a broadcast that a previously valid payment order could fail to reach settlement within 15 minutes. The debtor CLM account is shown along with the original priority, payment order UETR and the time of rejection.

Message item	Utilisation
Event Code	REJT
Document/SysEvtNtfctn/EvtInf/EvtCd	
Event Parameter	MDEEURCOBADEFFXXXCOBADEFFXXX
Document/SysEvtNtfctn/EvtInf/EvtParam	
Event Parameter	URGT
Document/SysEvtNtfctn/EvtInf/EvtParam	
Event Description	e009b079-59c5-41e9-be4c-d45102fc201e
Document/SysEvtNtfctn/EvtInf/EvtDesc	
Event Time	2020-10-13T10:18:15.001+00:00
Document/SysEvtNtfctn/EvtInf/EvtTm	

Table 104 - SystemEventNotification (admi.004) – usage case Payment reject time broadcast (Scenario 079)

Usage case example: admi.004_CLM_SystemEventNotification_RJCT_bs079.xml

Usage case: CLM operations Related broadcast (Scenario 080)

In this example, the CLM Operator is notifying the receiver by a broadcast message that a Party BIC has had to be blocked and advises that any payments sent for that party will be rejected.

Message item	Utilisation
Event Code	FREE
Document/SysEvtNtfctn/EvtInf/EvtCd	
Event Description	Participant BIC PRYBIC1XXX blocked, payments to it will be rejected
Document/SysEvtNtfctn/EvtInf/EvtDesc	
Event Time	2020-10-13T11:31:26.001+00:00
Document/SysEvtNtfctn/EvtInf/EvtTm	

Table 105 - SystemEventNotification (admi.004) – usage case CLM Operations Related broadcast (Scenario 080)

Usage case example: admi.004_CLM_SystemEventNotification_FREE_bs080.xml

12.1.2 ReportQueryRequest (admi.005)

12.1.2.1 Overview and scope of the message

This chapter illustrates the *ReportQueryRequest* message.

The *ReportQueryRequest* message is sent by a business sender to CLM to query the latest available report [BankToCustomerStatement \(camt.053\)](#) [▶ 511] (statement of account) for the specified cash account(s) or to query a copy of the [general ledger](#) [▶ 567] (CB only).

The business sender of the *ReportQueryRequest* can query within its data scope, which is determined by CLM party BIC and CLM MCA number.

The usage of this message is to be found in chapter [Usage of Messages](#) [▶ 324].

In response to the *ReportQueryRequest* message, the requested report message is returned. In the case of an error resulting from the processing of the *ReportQueryRequest*, error information is returned using a [ReceiptAcknowledgement \(admi.007\)](#) [▶ 370] message.

12.1.2.2 Schema

Outline of the schema

The *ReportQueryRequest* message is composed of the following building blocks.

MessageHeader

This building block is mandatory and provides a set of elements to identify the *ReportQueryRequest* message.

ReportQueryCriteria

This building block is mandatory and non-repetitive. It defines the report query criteria. It contains the elements:

- | report name;
- | report owning party BIC;
- | CLM MCA identifier.

References/links

The CLM-specific schema and documentation in XSD/Excel/PDF format as well as the message examples are provided outside of this document under the following link:

http://www.swift.com/mystandards/CLM/admi.005.001.01_CLM

Business rules applicable to the schema

For business rules applicable to *ReportQueryRequest* refer to chapter [Index of validation rules and error codes](#) [▶ 643].

12.1.2.3 The message in business context

Specific message requirements

All content must comply with the business rules for the message.

Message item	Utilisation
Message identification RptQryReq/MsgHdr/MsgId	Value "NONREF" as the message ID is already part of the BAH.
AccountIdentification RptQryCrit/SchCrit/AcctId/EQ/Othr/Id	CLM cash account number to be provided
Report Name RptQryCrit/SchCrit/RptNm/	SACC code for "Statement of Accounts" report type is allowed. GLFQ code for "General Ledger" report type is allowed only for CBs.
PartyIdentification RptQryCrit/SchCrit/PtyId/AnyBIC	A party will be identified via the CLM party BIC.

Table 106 - ReportQueryRequest (admi.005)

Usage case: Query Request Message - General Ledger Query (CB Only) (Scenario 066)

In this usage example, the business sender is requesting CLM to send the latest version of the General Ledger relating to a CB (BIC: "MARKDEFFXXX"):

Message item	Utilisation
Message identification RptQryReq/MsgHdr/MsgId	NONREF
Report Name RptQryCrit/SchCrit/RptNm/	GLFQ
PartyIdentification RptQryCrit/SchCrit/PtyId/AnyBIC	MARKDEFFXXX

Table 107 - ReportQueryRequest (admi.005) – usage case Query Request Message - General Ledger Query (CB Only) (Scenario 066)

Usage case example: **admi.005_CLM_ReportQueryRequest_bs066.xml**

Usage case: Query Request Message - Account Statement Query (Scenario 999)

In this usage example, the business sender is requesting CLM to send the latest version of the *BankToCustomerStatement* relating to an account (ID: "MDEEURSOLADESTXXXSOLADESTXXX") owned by party (BIC: "SOLADESTXXX"):

Message item	Utilisation
Message identification RptQryReq/MsgHdr/MsgId	NONREF
AccountIdentification RptQryCrit/SchCrit/AcctId/EQ/Othr/Id	MDEEURSOLADESTXXXSOLADESTXXX
Report Name RptQryCrit/SchCrit/RptNm/	SACC
PartyIdentification RptQryCrit/SchCrit/PtyId/AnyBIC	SOLADESTXXX

Table 108 - ReportQueryRequest (admi.005) – usage case Query Request Message - Account Statement Query (Scenario 999)

Usage case example: **admi.005_CLM_ReportQueryRequest_bs999.xml**

12.1.3 ReceiptAcknowledgement (admi.007)

12.1.3.1 Overview and scope of the message

This chapter illustrates the *ReceiptAcknowledgement* message.

The *ReceiptAcknowledgement* message is sent by CLM to the business sender of a previously sent message/file to inform of a validation error.

The *ReceiptAcknowledgement* message is sent without a BAH, if inbound message / inbound file were rejected for the usages "message rejection notification" and "file rejection notification".

The *ReceiptAcknowledgement* message is sent with a BAH, to inform of a validation error and switch of network service for the [ReportQueryRequest](#) [▶ 368] ([admi.005](#)) [▶ 368] message and [GetTransaction \(camt.005\)](#) [▶ 411] message.

The *ReceiptAcknowledgement* message is sent by CLM to the business sender of an Account statement query and Cash transfer query to inform of pagination and the respective switch to store-n-forward network

service. Additionally the respective query response is provided via store-n-forward network service. In case of a [General Ledger](#) [▶ 567] query (CB only) via [ReportQueryRequest \(admi.005\)](#) [▶ 368] the *ReceiptAcknowledgement* message is sent to inform about switch from real-time to store-n-forward network service since CLM sends a separate [general ledger](#) [▶ 567] per service.

The usage of this message is to be found in chapter [Usage of Messages](#) [▶ 324].

12.1.3.2 Schema

Outline of the schema

The *ReceiptAcknowledgement* message is composed of the following message building blocks.

MessageIdentification

MessageIdentification is mandatory but only used in case the message is sent without a BAH. If message is sent with a BAH, the value "NONREF" is used.

Report

This building block is mandatory and repetitive. Each block contains the message ID of the request message and information related to a single validation issue.

RelatedReference

This building block is mandatory and non-repetitive. It provides the reference on the request message to which this *ReceiptAcknowledgement* message is responding.

RequestHandling

This building block is mandatory and non-repetitive. It gives the status of the request. It may contain:

- | status code;
- | description.

References/links

The CLM-specific schema and documentation in XSD/Excel/PDF format as well as the message examples are provided outside of this document under the following link:

http://www.swift.com/mystandards/CLM/admi.007.001.01_CLM

Business rules applicable to the schema

No business rules are applicable to a *ReceiptAcknowledgement* message.

12.1.3.3 The message in business context

Specific message contents

Message item	Utilisation
Message Identification /Document/RctAck/Msgld/Msgld	Always value "NONREF" whether the admi.007 message is sent with a BAH or not. If the admi.007 is sent with a BAH the message ID of this business message is part of the BAH <BizMsgldr> field.
Related Reference /Document/RctAck/Rpt/RltdRef/Ref	Copy of BizMsgldr of inbound message / copy of Pyldldr of inbound file. If BizMsgldr of inbound message / Pyldldr of inbound file cannot be identified, this field contains "NONREF".
Status Code /Document/RctAck/Rpt/ReqHdlg/StsCd	Specifies the status of the request, for example the result of the schema validation or a business processing result/error.
Description /Document/RctAck/Rpt/ReqHdlg/Desc	Description of the status, in free format text.

Table 109 - ReceiptAcknowledgement (admi.007)

Usage case: Message Rejection Notification (Scenario 008)

In this usage example, CLM is advising the business sender (CB) of a previous pacs.009 message that the whole message has been rejected by CLM validation. The failing reason code is "E002" (wrong network service used) and the appropriate text for this error is also included. The previous pacs.009 can be identified using the pacs.009 BAH BizMsgldr which is supplied on the admi.007.

Message item	Utilisation
Message Identification /Document/RctAck/MsgId/MsgId	NONREF
Related Reference /Document/RctAck/Rpt/RltdRef/Ref	Inp009b008-BAHId
Status Code /Document/RctAck/Rpt/ReqHdlg/StsCd	E002
Description /Document/RctAck/Rpt/ReqHdlg/Desc	Unknown namespace or wrong network service

Table 110 - ReceiptAcknowledgement (admi.007) – Message Rejection Notification (Scenario 008)

Usage case example: admi.007_CLM_ReceiptAcknowledgement_Error_bs008.xml

Usage case: File Rejection Notification (Scenario 011)

In this usage example, CLM is advising the business sender of a previous file (identified as “Inh002b011-Field”) that the BFH that was used, has been rejected by CLM validation. The failing reason code is “E005” (CLM detected a previous use of the file identifier) and the appropriate text for this error is also included. The previous file can be identified using the BFH PyldIdr which is supplied in the RelatedReference block on the admi.007.

Message item	Utilisation
Message Identification /Document/RctAck/MsgId/MsgId	NONREF
Related Reference /Document/RctAck/Rpt/RltdRef/Ref	Inh002b011-Field
Status Code /Document/RctAck/Rpt/ReqHdlg/StsCd	E005
Description /Document/RctAck/Rpt/ReqHdlg/Desc	Duplicate file. PayloadIdentifier already used by party of business sending user (Signature).

Table 111 - ReceiptAcknowledgement (admi.007) – File Rejection Notification (Scenario 011)

Usage case example: admi.007_CLM_ReceiptAcknowledgement_Error_bs011.xml

Usage case: Query Rejection For Failed Business Validation - Account Statement Query

In this usage case, CLM is advising the business sender of a previous admi.005 message (account statement query) that the admi.005 has failed the CLM business validation rules and been rejected.

The failing reason code and descriptive text will be included in this admi.007, along with the BAH <BizMsgldr> from the failing inbound admi.005 to which it is responding.

Usage case example is not available.

Usage case: Query Rejection For Failed Business Validation - General Ledger Query (CB only)

In this usage case, CLM is advising the CB sender of a previous admi.005 message (general ledger query) that the admi.005 has failed the CLM business validation rules and been rejected.

The failing reason code and descriptive text will be included in this admi.007, along with the BAH <BizMsgldr> from the failing inbound admi.005 to which it is responding.

Usage case example is not available.

12.2 Cash management (camt)

12.2.1 GetAccount (camt.003)

12.2.1.1 Overview and scope of the message

This chapter illustrates the *GetAccount* message.

The *GetAccount* message is sent by a business sender to CLM.

The message can be sent by the following business sender:

- | CLM Account Holder;
- | co-manager;
- | CB.

This message has the following three query uses within CLM:

1) The "Available liquidity CLM query" is used to request CLM cash account balances and credit line information (if granted, only relevant for the default MCA) related to:

- | all cash accounts in the data scope of the business sender (without search criteria);
- | all cash accounts held by the account owner specified in the search criteria;
- | one cash account specified in the search criteria.

For this query use the query type code must no be used.

2) The "Minimum reserve fulfilment query" is used to request minimum reserve balances related to:

- | the data scope of the business sender without search criteria if the business sender is the account owner (non-leading CLM Account Holder), the leading CLM Account Holder, the co-manager (which is not the leading CLM Account Holder of its co-managee, but the co-managee (i) holds its minimum reserve directly and (ii) owns only one MCA and no further account(s) in any TARGET settlement service and (iii) is not the leading CLM Account Holder of other parties holding the minimum reserve indirectly) or the CB (banking community);
- | the leading CLM Account Holder BIC specified in the search criteria (account servicer BIC) if the business sender is a CB or a co-manager (which is not the leading CLM Account Holder of its co-managee, but the co-managee (i) holds its minimum reserve directly and (ii) owns only one MCA and no further account(s) in any TARGET settlement service and (iii) is not the leading CLM Account Holder of other parties holding the minimum reserve indirectly);
- | the account owner BIC specified in the search criteria if the business sender is a leading CLM Account Holder or the CB;
- | the account number specified in the search criteria if the business sender is the account owner (non-leading CLM Account Holder), the leading CLM Account Holder or the CB.

For this query use the query type code MRFQ (Minimum Reserve Fulfilment Query for current maintenance period) is required.

3) The "Minimum reserve requirement query" (available for CB only) is used to request minimum reserve requirements related to:

- | the data scope of the CB without search criteria (banking community);
- | the leading CLM Account Holder BIC specified in the search criteria (account servicer BIC);
- | the account owner BIC specified in the search criteria.

For this query use, the query type codes MRRC (Minimum Reserve Requirement Query for current maintenance period) or MRRN (Minimum Reserve Requirement Query for next maintenance period) are required.

Depending on the query use, the *GetAccount* message contains the optional search criteria which will be used to select the response information, based on the following elements:

- | CLM cash account number for available liquidity query use;
- | RTGS, CLM, TIPS or T2S cash account number for minimum reserve fulfilment query use;
- | CLM account owner BIC for all query uses;
- | Leading CLM account holder BIC (Account servicer) for minimum reserve fulfilment query use (CB only) or minimum reserve requirement query use (CB only).

The usage of this message is to be found in chapter [Usage of Messages](#) [324].

In response to the *GetAccount* message, a [ReturnAccount \(camt.004\)](#) [▶ 380] message containing either the requested information according to the specified search criteria or business validation error(s), is returned to the business sender.

12.2.1.2 Schema

Outline of the schema

The *GetAccount* message is composed of the following message building blocks.

MessageHeader

This building block is mandatory and non-repetitive. The identification by the business sender to uniquely and unambiguously identify the message is part of the BAH, therefore the content of message ID is "NONREF".

AccountQueryDefinition

This building block is optional and non-repetitive. It defines the criteria to be used to extract the account information and includes the following elements:

- | Account identification;
- | Account owner;
- | Account Servicer.

References/links

The CLM-specific schema and documentation in XSD/Excel/PDF format as well as the message examples are provided outside of this document under the following link:

http://www.swift.com/mystandards/CLM/camt.003.001.07_CLM

Business rules applicable to the schema

For business rules applicable to *GetAccount* refer to chapter [Index of validation rules and error codes](#) [▶ 643].

12.2.1.3 The message in business context

Specific message requirements

All content must comply with the business rules for the message.

Message item	Utilisation
Message Header	
Message Identification /Document/GetAcct/MsgHdr/MsgId	Value "NONREF" as the message ID is already part of the BAH.
Request Type Proprietary Identification /Document/GetAcct/MsgHdr/ReqTp/Prtry/Id	1) "Available liquidity CLM query": Element must not be used. 2) "Minimum reserve fulfilment query": Code "MRFQ" - Minimum Reserve Fulfilment Query for current maintenance period 3) "Minimum reserve requirement query": <ul style="list-style-type: none"> Code "MRRC" - Minimum Reserve Requirement Query for current maintenance period (CB only) Code "MRRN" - Minimum Reserve Requirement Query for next maintenance period (CB only)
Account Query Definition – Search Criteria	
Account Identification /Document/GetAcct/AcctQryDef/AcctCrit/NewCrit/SchCrit/AcctId/EQ/Othr/Id	1) "Available liquidity CLM query": Account number of CLM cash account. <ul style="list-style-type: none"> MCA CLM CB Account Overnight deposit account Marginal lending account 2) "Minimum reserve fulfilment query": Account number of <ul style="list-style-type: none"> CLM MCA RTGS DCA TIPS account T2S DCA 3) "Minimum reserve requirement query": Not allowed

Message item	Utilisation
Account Owner BIC /Document/GetAcct/AcctQryDef/AcctCrit/NewCrit/SchCrit/AcctOwnr/Id/OrgId/AnyBIC	BIC of CLM Account owner
LEI /Document/GetAcct/AcctQryDef/AcctCrit/NewCrit/SchCrit/AcctOwnr/Id/OrgId/LEI	If provided, this element is ignored by CLM.
Account Servicer BIC /Document/GetAcct/AcctQryDef/AcctCrit/NewCrit/SchCrit/AcctSvcr/FinInstnId/BICFI	BIC of Leading CLM Account Holder. Can only be used for "Minimum reserve requirement query" and "Minimum reserve fulfilment query" by a CB.

Table 112 - GetAccount (camt.003)

Usage case: CLM Get Account (Scenario 100)

In this example, the business sender is using an account ID criteria to indicate that only this account (ID: MDEEURSOLADESTXXXSOLADESTXXX) is to be queried.

Message item	Utilisation
Message Identification /Document/GetAcct/MsgHdr/MsgId	NONREF
Account Identification /Document/GetAcct/AcctQryDef/AcctCrit/NewCrit/SchCrit/AcctId/EQ/Othr/Id	MDEEURSOLADESTXXXSOLADESTXXX

Table 113 - GetAccount (camt.003) – usage case Request for account

Usage case example: camt.003_CLM_AccountQuery_bs100.xml

Usage case: CLM Get Account (Scenario 101)

In this example, the business sender is using a false account ID criteria to indicate that only this account (ID: MDEEURSOLADESTXXXSOLADEST123) is to be queried.

Message item	Utilisation
Message Identification /Document/GetAcct/MsgHdr/Msgld	NONREF
Account Identification /Document/GetAcct/AcctQryDef/AcctCrit/NewCrit/SchCrit/AcctId/EQ/Othr/Id	MDEEURSOLADESTXXXSOLADEST123

Table 114 - GetAccount (camt.003) – usage case Request for account with error response

Usage case example: camt.003_CLM_AccountQuery_bs101.xml

Usage case: CLM Get Account (Scenario 104)

In this example, the business sender (CB) is using a minimum reserve fulfilment query code with a lead party identifier to indicate only accounts under this lead party should be returned.

Message item	Utilisation
Message Identification /Document/GetAcct/MsgHdr/Msgld	NONREF
Request Type /Document/GetAcct/MsgHdr/ReqTp/Prtry/Id	MRFQ
Account Identification /Document/GetAcct/AcctQryDef/AcctCrit/NewCrit/SchCrit/AcctSvcr/FinInstnId/BICFI	COBADEFFXXX

Table 115 - GetAccount (camt.003) – usage case Request for minimum reserve fulfilment information by a CB, with data response

Usage case example: camt.003_CLM_AccountQuery_bs104.xml

Usage case: CLM Get Account (Scenario 105)

In this example, the business sender is using a minimum reserve fulfilment query code with an account id to indicate that minimum reserve fulfilment information for this account only should be returned.

Message item	Utilisation
Message Identification /Document/GetAcct/MsgHdr/Msgld	NONREF
Request Type /Document/GetAcct/MsgHdr/ReqTp/Prtry/ld	MRFQ
Account Identification /Document/GetAcct/AcctQryDef/AcctCrit/NewCrit/SchCrit/AcctId/EQ/Othr/ld	MDEEURSOLADESTXXXSOLADESTXXX

Table 116 - GetAccount (camt.003) – usage case Request for minimum reserve fulfilment information by a non-lead participant, with data response

Usage case example: camt.003_CLM_AccountQuery_bs105.xml

12.2.2 ReturnAccount (camt.004)

12.2.2.1 Overview and scope of the message

This chapter illustrates the *ReturnAccount* message.

This message has the following four query response uses within CLM:

CLM Push notification-Use:

The *ReturnAccount* message is sent by CLM as a push notification. This message has the following push notification uses within CLM:

- 1) “Floor/ceiling notification” to provide balance information related to the triggering floor/ceiling business function to the account owner.
- 2) “Spillover notification” to provide spillover balance information related to the triggering end of day business function to the CB.

CLM Query response-Use:

The *ReturnAccount* message is sent by CLM in response to a [GetAccount \(camt.003\)](#) [374] message. This message has the following four query response uses within CLM:

- 1) “Query response for available liquidity CLM query” to provide the requested balance information according to the specified search criteria or data scope.

2) "Query response for minimum reserve fulfilment query" to provide the requested minimum reserve fulfilment information for the current minimum reserve maintenance period. For this message use three different views containing different levels of minimum reserve fulfilment information (multiple <AccRpt> occurrences and multiple <MulBal> occurrences with different balance type codes as specified below) are provided.

Leader view:

- | if business sender is a CB and search criteria is not provided or if business sender is a CB and leading CLM Account Holder BIC is specified in the search criteria (account servicer BIC);
- | if business sender is a co-manager (which is not the leading CLM Account Holder of its co-managee, but the co-managee (i) holds its minimum reserve directly and (ii) owns only one MCA and no further account(s) in any TARGET settlement service and (iii) is not the leading CLM Account Holder of other parties holding the minimum reserve indirectly) and search criteria is not provided (in this case the co-manager will get its own minimum reserve fulfilment information as a leading CLM Account Holder – if applicable - as well as the information for its relevant co-managee(s)) or if business sender is a co-manager (which is not the leading CLM Account Holder of its co-managee, but the co-managee (i) holds its minimum reserve directly and (ii) owns only one MCA and no further account(s) in any TARGET settlement service and (iii) is not the leading CLM Account Holder of other parties holding the minimum reserve indirectly) and leading CLM Account Holder BIC is specified in the search criteria (account servicer BIC);
Note: For co-managing CBs only: In case the co-manager is a CB party co-managing a co-managee related to another CB community, the co-managing CB will receive only the "national view" on its own CB community without cross-border co-managees in case no search criteria are provided. For querying the cross-border co-managee minimum reserve information, the co-managing CB needs to use search criteria account servicer BIC;
- | if business sender is a leading CLM Account Holder and search criteria is not provided.

The leader view provides the following information on leader level for each leading CLM Account Holder subject to minimum reserve obligation:

- | "BLCK" - minimum reserve requirement;
- | "ADJT" - adjustment balance;
- | "PRAV" - running average;
- | "EXRE" - excess reserve exemption threshold (exempt tier);
- | "EXRR" - excess reserve remuneration balance (non-exempt tier).

Additionally it provides the following information on party level for each Account Owner subject to minimum reserve obligation (exception: If there is a party leading only itself and no other parties information on party level is not provided for this leader):

- | "BLCK" - minimum reserve requirement;
- | "EXRE" - excess reserve exemption threshold (exempt tier) if relevant.

Furthermore, it provides the following information on account level for each account configured for inclusion in minimum reserve calculation:

- | "CLSG" - closing balance.

Party view:

- | if business sender is a CB and search criteria Account Owner BIC is provided;
- | if business sender is a leading CLM Account Holder and search criteria Account Owner BIC is provided;
- | if business sender is an Account Owner (non-leading CLM Account Holder) and search criteria is not provided.

The party view provides the following information on party level for each Account Owner subject to minimum reserve obligation:

- | "BLCK" - minimum reserve requirement;
- | "EXRE" - excess reserve exemption threshold (exempt tier) if relevant.

Furthermore, it provides the following information on account level for each account configured for inclusion in minimum reserve calculation:

- | "CLSG" - closing balance.

Account view:

- | if business sender is a CB and search criteria account number is provided;
- | if business sender is a leading CLM Account Holder and search criteria account number is provided;
- | if business sender is an Account Owner (non-leading CLM Account Holder) and search criteria account number is provided.

The account view provides the following information on account level:

- | "CLSG" - closing balance.

3) "Query response for minimum reserve requirements query (CB only)" to provide the requested minimum reserve requirement information for the current or next minimum reserve maintenance period.

For this message use two different views containing different levels of minimum reserve requirement information (multiple <AccRpt> occurrences and multiple <MulBal> occurrences with different balance type codes as specified below) are provided.

Leader view:

If search criteria is not provided or if leading CLM Account Holder BIC is specified in the search criteria (account servicer BIC).

The leader view provides the following information on leader level for each leading CLM Account Holder subject to minimum reserve obligation:

- | "BLCK" - minimum reserve requirement;

- | "EXRE" - excess reserve exemption threshold (exempt tier) if relevant.

Additionally it provides the following information on party level for each Account Owner subject to minimum reserve obligation (exception: If there is a party leading only itself and no other parties information on party level is not provided for this leader):

- | "BLCK" - minimum reserve requirement;
- | "EXRE" - excess reserve exemption threshold (exempt tier) if relevant.

Party view:

If search criteria Account Owner BIC is provided.

The party view provides the following information on party level for each Account Owner subject to minimum reserve obligation:

- | "BLCK" - minimum reserve requirement;
- | "EXRE" - excess reserve exemption threshold (exempt tier) if relevant.

4) "Query rejection for failed business validation" in case of business validation error(s) on the GetAccount query. CLM sends the *ReturnAccount* message containing the respective error code(s) and error description(s) to the business receiver.

The usage of this message is to be found in chapter [Usage of Messages](#) [▶ 324].

12.2.2.2 Schema

Outline of the schema

The *ReturnAccount* message is composed of the following message building blocks.

MessageHeader

This building block is mandatory and non-repetitive. It must contain an identification assigned by the sending party to uniquely and unambiguously identify the message.

ReportOrError

This building block is mandatory and non-repetitive. It contains either the information matching the search criteria of the related business query about account or an error indication.

AccountReport

This building block is mandatory and repetitive. It reports either one or more account information and may contain:

- | account identification;
- | account type;

- | currency;
- | account owner;
- | Account Servicer;
- | multilateral balances (multiple).

References/links

The CLM-specific schema and documentation in XSD/Excel/PDF format as well as the message examples are provided outside of this document under the following link:

http://www.swift.com/mystandards/CLM/camt.004.001.08_CLM

Business rules applicable to the schema

No business rules are applicable to a *ReturnAccount* message.

12.2.2.3 The message in business context

Specific message contents

Message item	Utilisation
Message Header	
Message Identification /Document/RtrAcct/MsgHdr/MsgId	Value "NONREF" as the Message ID is already part of the BAH
Request Type Proprietary Identification /Document/GetAcct/MsgHdr/ReqTp/Prtry/Id	1) "Query response for available liquidity CLM query": Not used 2) "Query response for minimum reserve fulfilment query": MRFQ - Minimum Reserve Fulfilment Query response for current maintenance period 3) "Query response for minimum reserve requirement query": Depending on the query sent to CLM, one of the following codes will be reported: <ul style="list-style-type: none"> MRRC - Minimum Reserve Requirement Query response for current maintenance period MRRN - Minimum Reserve Requirement Query response for next maintenance period
Original Business Query Message Identification /Document/RtrAcct/MsgHdr/OrgnlBizQry/MsgId	CLM Push notification-use: Value "NONREF" CLM Query response-use: Copy of BAH BizMsgIdr of

Message item	Utilisation
	GetAccount [374] message
<p>Account Report</p> <p>CLM Push notification-Use: 1) "Floor/ceiling notification" + 2) "Spillover notification": Always one occurrence of <AcctRpt> message block is provided.</p> <p>CLM Query response-Use: One or multiple occurrences of <AcctRpt> message block are provided according to datascope and specified search criteria in the query. For details see scope description of message.</p>	
<p>Account Identification</p> <p>/Document/RtrAcct/RptOrErr/AcctRpt/AcctId/Othr/Id</p>	<p>CLM Push notification-Use:</p> <p>CLM cash account</p> <p>Number</p> <p>CLM Query response-Use:</p> <p>1) "Query response for available liquidity CLM query": CLM cash account number</p> <p>2) "Query response for minimum reserve fulfilment query":</p> <ul style="list-style-type: none"> for each information on leader level: fixed term "Leader Minimum Reserve Amounts" for each information on party level: fixed term "Party Minimum Reserve Amounts" for each information on account level cash account number provided in element <AcctId> in camt.003. If no cash account number was provided, camt.004 reports all cash accounts relevant for minimum reserve fulfilment according to the provided search criteria or in the data scope of the business sender <p>3) "Query response for minimum reserve requirement query":</p> <ul style="list-style-type: none"> for each information on leader level: fixed term "Leader Minimum Reserve Amounts" for each information on party level: fixed term "Party Minimum Reserve Amounts"
<p>Account Type Code</p> <p>/Document/RtrAcct/RptOrErr/AcctRpt/AcctOrErr/Acct/Tp/Cd</p>	<p>CLM Push notification-Use:</p> <p>1) "Floor/ceiling notification": Not used.</p> <p>2) "Spillover notification": always CACC - CLM MCA</p> <p>CLM Query response-Use:</p> <p>1) "Query response for available liquidity CLM query":</p>

Message item	Utilisation
	<ul style="list-style-type: none"> CACC - CLM cash account except marginal lending account or overnight deposit account MGLD - Marginal lending account ONDP - Overnight deposit account <p>2) "Query response for minimum reserve fulfilment query":</p> <ul style="list-style-type: none"> <Tp> is only provided if a cash account number is provided in <AcctId> (i.e. information on account level). Not used for fixed terms in <AcctId> (i.e. information on leader or party level). CACC - CLM MCA SACC - RTGS DCA OTHR - TIPS account CASH - T2S DCA <p>3) "Query response for minimum reserve requirement query": Not used.</p>
<p>Currency</p> <p>/Document/RtrAcct/RptOrErr/AcctRpt/AcctOrErr/Acct/Ccy</p>	<p>CLM Push notification-Use:</p> <p>Specifies the currency of the cash account.</p> <p>CLM Query response-Use:</p> <p>1) "Query response for available liquidity CLM query": Specifies the currency of the cash account.</p> <p>2) "Query response for minimum reserve fulfilment query" +</p> <p>3) "Query response for minimum reserve requirement query": always EUR.</p>
<p>Account Owner Name</p> <p>/Document/RtrAcct/RptOrErr/AcctRpt/AcctOrErr/Acct/Ownr/Nm</p>	<p>CLM Push notification-Use:</p> <p>Not used.</p> <p>CLM Query response-Use:</p> <p>1) "Query response for available liquidity CLM query": Name of party owning the reported CLM cash account.</p> <p>2) "Query response for minimum reserve fulfilment query" +</p> <p>3) "Query response for minimum reserve requirement query": Not used.</p>
<p>Account Owner BIC</p> <p>/Document/RtrAcct/RptOrErr/AcctRpt/AcctOrErr/Acct/Ownr/</p>	<p>CLM Push notification-Use:</p> <p>Party BIC of CLM cash account owner.</p>

Fehler! Verwenden Sie die Registerkarte 'Start', um dem Text zuzuweisen,

Message item	Utilisation
Id/OrgId/AnyBIC	<p>CLM Query response-Use:</p> <p>1) "Query response for available liquidity CLM query": Party BIC of CLM cash account owner.</p> <p>2) "Query response for minimum reserve fulfilment query":</p> <ul style="list-style-type: none"> for each information on leader level: Not used. for each information on party level: Party BIC of party subject to minimum reserve obligation. for each information on account level: Party BIC of CLM cash account owner. <p>3) "Query response for minimum reserve requirement query":</p> <ul style="list-style-type: none"> for each information on leader level: Not used. for each information on party level: Party BIC of party subject to minimum reserve obligation.
LEI	CLM Push notification-Use: Not provided by CLM
/Document/RtrAcct/RptOrErr/AcctRpt/AcctOrErr/Acct/Ownr/Id/OrgId/LEI	CLM Query response-Use: Not provided by CLM
Account Servicer BIC	<p>CLM Push notification-Use:</p> <p>Not used.</p> <p>CLM Query response-Use:</p> <p>1) "Query response for available liquidity CLM query": Not used.</p> <p>2) "Query response for minimum reserve fulfilment query":</p> <ul style="list-style-type: none"> for each information on leader level: Party BIC of leading CLM Account Holder. for each information on party level: Party BIC of leading CLM Account Holder linked to reported party. for each information on account level: Party BIC of leading CLM Account Holder linked to reported account. <p>3) "Query response for minimum reserve requirement query":</p> <ul style="list-style-type: none"> for each information on leader level: Party BIC of leading CLM Account Holder.
/Document/RtrAcct/RptOrErr/AcctRpt/AcctOrErr/Acct/Svcr/FinInstnId/BICFI	

Message item	Utilisation
	<ul style="list-style-type: none"> for each information on party level: Party BIC of leading CLM Account Holder linked to reported party.
Multilateral Balance	
Amount /Document/RtrAcct/RptOrErr/AcctRpt/AcctOrErr/Acct/MulBa I/Amt	Currency and amount of money of the cash balance.
Credit Debit Indicator /Document/RtrAcct/RptOrErr/AcctRpt/AcctOrErr/Acct/MulBa I/CdtDbtInd	<p>CLM Push notification-Use:</p> <p>1) "Floor/ceiling notification": Always CRDT (credit balance).</p> <p>2) "Spillover notification": Always DBIT (debit balance).</p> <p>CLM Query response-Use:</p> <p>Balance type codes OPNG, CLSG, CRRT, XPCD, AVLB, DLOD, BLCK, ADJT, PRAV, EXRE, EXRR: Indicates whether the balance is a credit or a debit balance. A zero balance is reported with a credit indicator.</p> <p>One <MulBal> occurrence per status with either "DBIT" or "CRDT".</p> <p>Balance type codes NOTE, LTSF, PYMT: Indicates whether the amount increases (CRDT) or decreases (DBIT) the cash account balance.</p> <p>One <MulBal> occurrence per status for sum of "CRDT" and one <MulBal> occurrence per status for sum of "DBIT".</p>
Multilateral Balance Code /Document/RtrAcct/RptOrErr/AcctRpt/AcctOrErr/Acct/MulBa I/Tp/Cd	<p>CLM Push notification-Use:</p> <p>1) "Floor/ceiling notification": AVLB - Available liquidity (if reservation for seizure of funds is set up, then available liquidity is already reduced by the seized amount.) (status STLD)</p> <p>2) "Spillover notification": CRRT - Current balance (status not provided)</p> <p>CLM Query response-Use:</p> <p>1) "Query response for available liquidity CLM query":</p> <ul style="list-style-type: none"> OPNG - Opening balance (status STLD) AVLB - Available liquidity (if reservation for seizure of funds is set up, then available liquidity is already

Fehler! Verwenden Sie die Registerkarte 'Start', um dem Text zuzuweisen,

Message item	Utilisation
	<p>reduced by the seized amount.) (status STLD)</p> <ul style="list-style-type: none"> CRRT - Current balance (status STLD) DLOD - Daylight overdraft (if credit line is granted on default MCA) (status STLD or PDNG) NOTE - Earmarked cash transfers (status PDNG) XPCD - Projected liquidity (status PDNG) LTSF - Liquidity transfer (status STLD or PDNG) PYMT - Payments (status STLD or PDNG) <p>2) "Query response for minimum reserve fulfilment query":</p> <ul style="list-style-type: none"> CLSG - Closing balance BLCK - Requirement for minimum reserve ADJT - Adjustment balance for minimum reserve PRAV - Running average for minimum reserve EXRE - Excess reserve exemption threshold (exempt tier) EXRR - Excess reserve remuneration balance (non-exempt tier) For all codes always no status will be provided. <p>3) "Query response for minimum reserve requirement query":</p> <ul style="list-style-type: none"> BLCK - Requirement for minimum reserve EXRE - Excess reserve exemption threshold (exempt tier) <p>For all codes always no status will be provided.</p>
<p>Multilateral Balance Proprietary /Document/RtrAcct/RptOrErr/AcctRpt/AcctOrErr/Acct/MulBa I/Tp/Prtry</p>	<p>CLM Push notification-Use:</p> <p>1) "Floor/ceiling notification"</p> <ul style="list-style-type: none"> FLOR - floor notification trigger amount (status not provided) CEIL - ceiling notification trigger amount (status not provided). <p>2) "Spillover notification": Not used.</p> <p>CLM Query response-Use: Not used.</p>
<p>Status</p>	<p>CLM Push notification-Use:</p>

Message item	Utilisation
/Document/RtrAcct/RptOrErr/AcctRpt/AcctOrErr/Acct/MulBal/STS	<p>1) "Floor/ceiling notification": Status is partially provided.</p> <p>2) "Spillover notification": Status is not provided.</p> <p>CLM Query response-Use:</p> <p>1) "Query response for available liquidity CLM query": Status is always provided.</p> <p>2) "Query response for minimum reserve fulfilment query": Status is not provided.</p> <p>3) "Query response for minimum reserve requirement query": Status is not provided.</p>
Value Date Date /Document/RtrAcct/RptOrErr/AcctRpt/AcctOrErr/Acct/MulBal/ValDt/Dt	<p>CLM Push notification-Use: Date expressed in business day.</p> <p>1) "Floor/ceiling notification": For Balance Type AVLB only. Always current business day.</p> <p>2) "Spillover notification": Always current business day.</p> <p>CLM Query response-Use: Date expressed in business day.</p> <p>1) "Query response for available liquidity CLM query": Always current business day.</p> <p>2) "Query response for minimum reserve fulfilment query": Always previous business day.</p> <p>3) "Query response for minimum reserve requirement query": Always previous business day. .</p>
Processing Date Date /Document/RtrAcct/RptOrErr/AcctRpt/AcctOrErr/Acct/MulBal/PrcgDt/Dt	<p>CLM Push notification-Use: Not used.</p> <p>CLM Query response-Use: Current system date expressed in calendar day (UTC).</p> <p>Provided for available liquidity query response for balance type codes CRRT, XPCD, AVLB, DLOD, NOTE, LTSF and PYMT.</p>
Operational Error	
Error /Document/RtrAcct/RptOrErr/OpriErr/Err/Prtry	For further detailed information refer to chapter Index of validation rules and error codes [643].
Description /Document/RtrAcct/RptOrErr/OpriErr/Desc	Specification of the error, in free format

Table 117 - ReturnAccount (camt.004)

Usage case: Return Account (Scenario 074)

In this example, CLM is advising a CB that the PB owning the CLM MCA (Id “MDEEURCOBADEFFXXXCOBADEFFXXX”) has a current negative balance of EUR3800,00 which means that the bank is in a spillover situation and is unable to fulfill its overnight balance obligations.

Message item	Utilisation
Message Identification /Document/RtrAcct/MsgHdr/MsgId	NONREF
Original Business Query /Document/RtrAcct/MsgHdr/OrgnIBizQry/MsgId	NONREF
Account Report	
Account Identification /Document/RtrAcct/RptOrErr/AcctRpt/AcctId/Othr/Id	MDEEURCOBADEFFXXXCOBADEFFXXX
Account Type /Document/RtrAcct/RptOrErr/AcctRpt/AcctOrErr/Acct/Tp/Cd	CACC
Currency /Document/RtrAcct/RptOrErr/AcctRpt/AcctOrErr/Acct/Ccy	EUR
Account Owner /Document/RtrAcct/RptOrErr/AcctRpt/AcctOrErr/Acct/Ownr/Id/OrgId/AnyBIC	COBADEFFXXX
Multilateral Balance	
Amount /Document/RtrAcct/RptOrErr/AcctRpt/AcctOrErr/Acct/MulBal/Amt	3800.00

Message item	Utilisation
Credit Debit Indicator /Document/RtrAcct/RptOrErr/AcctRpt/AcctOrErr/Acct/MulBa l/CdtDbtInd	DBIT
Multilateral Balance Code /Document/RtrAcct/RptOrErr/AcctRpt/AcctOrErr/Acct/MulBa l/Tp/Prtry	CRRT
Value Date Date /Document/RtrAcct/RptOrErr/AcctRpt/AcctOrErr/Acct/MulBa l/ValDt/Dt	2019-10-09

Table 118 - ReturnAccount (camt.004) – usage case CLM spillover notification

Usage case example: camt.004_CLM_ReturnAccount_Spillover_bs074.xml

Usage case: Return Account (Scenario 084 FLOR)

In this example, CLM is notifying the receiver that the successful settlement of a liquidity transfer (in this case, E2E-Id: Inc050b050-E2Eid from bs050 on 8th October, 2019) has caused the debited account (AcctId: MDEEURCOBADEFFXXXCOBADEFFXXX) to breach its pre-defined floor limit.

The balances provided are: the pre-defined floor limit and the current balance immediately following the settlement.

Message item	Utilisation
Message Identification /Document/RtrAcct/MsgHdr/MsgId	NONREF
Original Business Query /Document/RtrAcct/MsgHdr/OrgnlBizQry/MsgId	NONREF
Account Report	
Account Identification /Document/RtrAcct/RptOrErr/AcctRpt/AcctId/Othr/Id	MDEEURCOBADEFFXXXCOBADEFFXXX
Currency /Document/RtrAcct/RptOrErr/AcctRpt/AcctOrErr/Acct/Ccy	EUR
Account Owner /Document/RtrAcct/RptOrErr/AcctRpt/AcctOrErr/Acct/Ownr/ Id/OrgId/AnyBIC	COBADEFFXXX

Message item	Utilisation
Multilateral Balance	
Amount /Document/RtrAcct/RptOrErr/AcctRpt/AcctOrErr/Acct/MulBa I/Amt	75000.00
Credit Debit Indicator /Document/RtrAcct/RptOrErr/AcctRpt/AcctOrErr/Acct/MulBa I/CdtDbtInd	CRDT
Multilateral Balance Code /Document/RtrAcct/RptOrErr/AcctRpt/AcctOrErr/Acct/MulBa I/Tp/Prtry	FLOR
Multilateral Balance	
Amount /Document/RtrAcct/RptOrErr/AcctRpt/AcctOrErr/Acct/MulBa I/Amt	150.00
Credit Debit Indicator /Document/RtrAcct/RptOrErr/AcctRpt/AcctOrErr/Acct/MulBa I/CdtDbtInd	CRDT
Multilateral Balance Code /Document/RtrAcct/RptOrErr/AcctRpt/AcctOrErr/Acct/MulBa I/Tp/Cd	AVLB
Multilateral Balance Code /Document/RtrAcct/RptOrErr/AcctRpt/AcctOrErr/Acct/MulBa I/Sts	STLD
Value Date Date /Document/RtrAcct/RptOrErr/AcctRpt/AcctOrErr/Acct/MulBa I/ValDt/Dt	2019-10-09

Table 119 - ReturnAccount (camt.004) – usage case CLM threshold breaches - FLOR

Usage case example: camt.004_CLM_ReturnAccount_FLOR_bs084.xml

Usage case: Return Account (Scenario 084 CEIL)

In this example, CLM is notifying the receiver that the successful settlement of a liquidity transfer (in this case, E2E-Id: Inc050b050-E2Eid from bs050 on 8th October, 2019) has caused the credited account (Acct Id: MDEEURSOLADESTXXXSOLADESTXXX) to breach its pre-defined ceiling limit.

The balances provided are: the pre-defined ceiling limit and the current balance immediately following the settlement.

Message item	Utilisation
Message Identification /Document/RtrAcct/MsgHdr/MsgId	NONREF
Original Business Query /Document/RtrAcct/MsgHdr/OrgnlBizQry/MsgId	NONREF
Account Report	
Account Identification /Document/RtrAcct/RptOrErr/AcctRpt/AcctId/Othr/Id	MDEEURSOLADESTXXXSOLADESTXXX
Currency /Document/RtrAcct/RptOrErr/AcctRpt/AcctOrErr/Acct/Ccy	EUR
Account Owner /Document/RtrAcct/RptOrErr/AcctRpt/AcctOrErr/Acct/Ownr/Id/OrgId/AnyBIC	SOLADESTXXX
Multilateral Balance	
Amount /Document/RtrAcct/RptOrErr/AcctRpt/AcctOrErr/Acct/MulBalance/Amt	600000.00
Credit Debit Indicator /Document/RtrAcct/RptOrErr/AcctRpt/AcctOrErr/Acct/MultilateralBalance/CdtDbtInd	CRDT
Multilateral Balance Code /Document/RtrAcct/RptOrErr/AcctRpt/AcctOrErr/Acct/MultilateralBalance/Type/Prtry	CEIL
Multilateral Balance	
Amount /Document/RtrAcct/RptOrErr/AcctRpt/AcctOrErr/Acct/MultilateralBalance/Amt	622000.00

Message item	Utilisation
I/Amt	
Credit Debit Indicator /Document/RtrAcct/RptOrErr/AcctRpt/AcctOrErr/Acct/MulBa I/CdtDbtInd	CRDT
Multilateral Balance Code /Document/RtrAcct/RptOrErr/AcctRpt/AcctOrErr/Acct/MulBa I/Tp/Cd	AVLB
Multilateral Balance Code /Document/RtrAcct/RptOrErr/AcctRpt/AcctOrErr/Acct/MulBa I/Sts	STLD
Value Date Date /Document/RtrAcct/RptOrErr/AcctRpt/AcctOrErr/Acct/MulBa I/ValDt/Dt	2019-10-08

Table 120 - ReturnAccount (camt.004) – usage case CLM threshold breaches - CEIL

Usage case example: camt.004_CLM_ReturnAccount_CEIL_bs084.xml

Usage case: Return Account (Scenario 100)

In this example, CLM is responding to the business sender with the balance information resulting from a valid camt.003 query for CLM account ID:

“MDEEURSOLADESTXXXSOLADESTXXX”.

The opening balance (as at start of business day) shows as EUR 0.

The current balance shows as EUR 100,000 Credit, which reflects the effect of two settlements:

1. the pacs.009 from scenario 002;
2. the camt.050 from scenario 050

The BAH business identification of the camt.003 query is included for recognition.

Message item	Utilisation
Message Identification /Document/RtrAcct/MsgHdr/MsgId	NONREF
Original Business Query /Document/RtrAcct/MsgHdr/OrgnlBizQry	Inc003b100-BAHId

Message item	Utilisation
Account Identification /Document/RtrAcct/RptOrErr/AcctRpt/AcctId/Othr/Id	MDEEURSOLADESTXXXSOLADESTXXX
Account Type /Document/RtrAcct/RptOrErr/AcctRpt/AcctOrErr/Acct/Tp/Cd	CACC
Currency /Document/RtrAcct/RptOrErr/AcctRpt/AcctOrErr/Acct/Ccy	EUR
Account Owner Name /Document/RtrAcct/RptOrErr/AcctRpt/AcctOrErr/Acct/Ownr/Nm	Landesbank-Baden-Wuerttemberg, Stuttgart
Account Owner BIC /Document/RtrAcct/RptOrErr/AcctRpt/AcctOrErr/Acct/Ownr/Id/OrgId/AnyBIC	SOLADESTXXX
Multilateral Balance	
Amount /Document/RtrAcct/RptOrErr/AcctRpt/AcctOrErr/Acct/MulBalance/Amt	0.00
Credit Debit Indicator /Document/RtrAcct/RptOrErr/AcctRpt/AcctOrErr/Acct/MulBalance/CdtDbtInd	CRDT
Multilateral Balance Code /Document/RtrAcct/RptOrErr/AcctRpt/AcctOrErr/Acct/MulBalance/Tp/Cd	OPNG
Status /Document/RtrAcct/RptOrErr/AcctRpt/AcctOrErr/Acct/MulBalance/Sts	STLD
Value Date Date /Document/RtrAcct/RptOrErr/AcctRpt/AcctOrErr/Acct/MulBalance/ValDt/Dt	2019-10-08
Multilateral Balance	
Amount /Document/RtrAcct/RptOrErr/AcctRpt/AcctOrErr/Acct/MulBalance/Amt	100000.00

Fehler! Verwenden Sie die Registerkarte 'Start', um dem Text zuzuweisen,

Message item	Utilisation
Credit Debit Indicator /Document/RtrAcct/RptOrErr/AcctRpt/AcctOrErr/Acct/MulBa I/CdtDbtInd	CRDT
Multilateral Balance Code /Document/RtrAcct/RptOrErr/AcctRpt/AcctOrErr/Acct/MulBa I/Tp/Cd	CRRT
Status /Document/RtrAcct/RptOrErr/AcctRpt/AcctOrErr/Acct/MulBa I/Sts	STLD
Value Date Date /Document/RtrAcct/RptOrErr/AcctRpt/AcctOrErr/Acct/MulBa I/ValDt/Dt	2019-10-08
Processing Date Date /Document/RtrAcct/RptOrErr/AcctRpt/AcctOrErr/Acct/MulBa I/PrcgDt/Dt	2019-10-08
Multilateral Balance	
Amount /Document/RtrAcct/RptOrErr/AcctRpt/AcctOrErr/Acct/MulBa I/Amt	100000.00
Credit Debit Indicator /Document/RtrAcct/RptOrErr/AcctRpt/AcctOrErr/Acct/MulBa I/CdtDbtInd	CRDT
Multilateral Balance Code /Document/RtrAcct/RptOrErr/AcctRpt/AcctOrErr/Acct/MulBa I/Tp/Cd	AVBL
Status /Document/RtrAcct/RptOrErr/AcctRpt/AcctOrErr/Acct/MulBa I/Sts	STLD
Value Date Date /Document/RtrAcct/RptOrErr/AcctRpt/AcctOrErr/Acct/MulBa I/ValDt/Dt	2019-10-08
Processing Date Date	2019-10-08

Message item	Utilisation
/Document/RtrAcct/RptOrErr/AcctRpt/AcctOrErr/Acct/MulBa I/PrcgDt/Dt	
Multilateral Balance	
Amount /Document/RtrAcct/RptOrErr/AcctRpt/AcctOrErr/Acct/MulBa I/Amt	0.00
Credit Debit Indicator /Document/RtrAcct/RptOrErr/AcctRpt/AcctOrErr/Acct/MulBa I/CdtDbtInd	CRDT
Multilateral Balance Code /Document/RtrAcct/RptOrErr/AcctRpt/AcctOrErr/Acct/MulBa I/Tp/Cd	DLOD
Status /Document/RtrAcct/RptOrErr/AcctRpt/AcctOrErr/Acct/MulBa I/Sts	STLD
Value Date Date /Document/RtrAcct/RptOrErr/AcctRpt/AcctOrErr/Acct/MulBa I/ValDt/Dt	2019-10-08
Processing Date Date /Document/RtrAcct/RptOrErr/AcctRpt/AcctOrErr/Acct/MulBa I/PrcgDt/Dt	2019-10-08
Multilateral Balance	
Amount /Document/RtrAcct/RptOrErr/AcctRpt/AcctOrErr/Acct/MulBa I/Amt	0.00
Credit Debit Indicator /Document/RtrAcct/RptOrErr/AcctRpt/AcctOrErr/Acct/MulBa I/CdtDbtInd	CRDT
Multilateral Balance Code /Document/RtrAcct/RptOrErr/AcctRpt/AcctOrErr/Acct/MulBa I/Tp/Cd	DLOD
Status	PDNG

Fehler! Verwenden Sie die Registerkarte 'Start', um dem Text zuzuweisen,

Message item	Utilisation
/Document/RtrAcct/RptOrErr/AcctRpt/AcctOrErr/Acct/MulBa I/Sts	
Value Date Date	2019-10-08
/Document/RtrAcct/RptOrErr/AcctRpt/AcctOrErr/Acct/MulBa I/ValDt/Dt	
Processing Date Date	2019-10-08
/Document/RtrAcct/RptOrErr/AcctRpt/AcctOrErr/Acct/MulBa I/PrcgDt/Dt	
Multilateral Balance	
Amount	0.00
/Document/RtrAcct/RptOrErr/AcctRpt/AcctOrErr/Acct/MulBa I/Amt	
Credit Debit Indicator	CRDT
/Document/RtrAcct/RptOrErr/AcctRpt/AcctOrErr/Acct/MulBa I/CdtDbtInd	
Multilateral Balance Code	NOTE
/Document/RtrAcct/RptOrErr/AcctRpt/AcctOrErr/Acct/MulBa I/Tp/Cd	
Status	PDNG
/Document/RtrAcct/RptOrErr/AcctRpt/AcctOrErr/Acct/MulBa I/Sts	
Value Date Date	2019-10-08
/Document/RtrAcct/RptOrErr/AcctRpt/AcctOrErr/Acct/MulBa I/ValDt/Dt	
Processing Date Date	2019-10-08
/Document/RtrAcct/RptOrErr/AcctRpt/AcctOrErr/Acct/MulBa I/PrcgDt/Dt	
Multilateral Balance	
Amount	0.00
/Document/RtrAcct/RptOrErr/AcctRpt/AcctOrErr/Acct/MulBa I/Amt	
Credit Debit Indicator	DBIT

Message item	Utilisation
/Document/RtrAcct/RptOrErr/AcctRpt/AcctOrErr/Acct/MulBa I/CdtDbtInd	
Multilateral Balance Code /Document/RtrAcct/RptOrErr/AcctRpt/AcctOrErr/Acct/MulBa I/Tp/Cd	NOTE
Status /Document/RtrAcct/RptOrErr/AcctRpt/AcctOrErr/Acct/MulBa I/Sts	PDNG
Value Date Date /Document/RtrAcct/RptOrErr/AcctRpt/AcctOrErr/Acct/MulBa I/ValDt/Dt	2019-10-08
Processing Date Date /Document/RtrAcct/RptOrErr/AcctRpt/AcctOrErr/Acct/MulBa I/PrcgDt/Dt	2019-10-08
Multilateral Balance	
Amount /Document/RtrAcct/RptOrErr/AcctRpt/AcctOrErr/Acct/MulBa I/Amt	100000.00
Credit Debit Indicator /Document/RtrAcct/RptOrErr/AcctRpt/AcctOrErr/Acct/MulBa I/CdtDbtInd	CRDT
Multilateral Balance Code /Document/RtrAcct/RptOrErr/AcctRpt/AcctOrErr/Acct/MulBa I/Tp/Cd	XPCD
Status /Document/RtrAcct/RptOrErr/AcctRpt/AcctOrErr/Acct/MulBa I/Sts	PDNG
Value Date Date /Document/RtrAcct/RptOrErr/AcctRpt/AcctOrErr/Acct/MulBa I/ValDt/Dt	2019-10-08
Processing Date Date /Document/RtrAcct/RptOrErr/AcctRpt/AcctOrErr/Acct/MulBa	2019-10-08

Fehler! Verwenden Sie die Registerkarte 'Start', um dem Text zuzuweisen,

Message item	Utilisation
I/PrcgDt/Dt	
Multilateral Balance	
Amount /Document/RtrAcct/RptOrErr/AcctRpt/AcctOrErr/Acct/MulBa I/Amt	100000.00
Credit Debit Indicator /Document/RtrAcct/RptOrErr/AcctRpt/AcctOrErr/Acct/MulBa I/CdtDbtInd	CRDT
Multilateral Balance Code /Document/RtrAcct/RptOrErr/AcctRpt/AcctOrErr/Acct/MulBa I/Tp/Cd	LTSF
Status /Document/RtrAcct/RptOrErr/AcctRpt/AcctOrErr/Acct/MulBa I/Sts	STLD
Value Date Date /Document/RtrAcct/RptOrErr/AcctRpt/AcctOrErr/Acct/MulBa I/ValDt/Dt	2019-10-08
Processing Date Date /Document/RtrAcct/RptOrErr/AcctRpt/AcctOrErr/Acct/MulBa I/PrcgDt/Dt	2019-10-08
Multilateral Balance	
Amount /Document/RtrAcct/RptOrErr/AcctRpt/AcctOrErr/Acct/MulBa I/Amt	0.00
Credit Debit Indicator /Document/RtrAcct/RptOrErr/AcctRpt/AcctOrErr/Acct/MulBa I/CdtDbtInd	DBIT
Multilateral Balance Code /Document/RtrAcct/RptOrErr/AcctRpt/AcctOrErr/Acct/MulBa I/Tp/Cd	LTSF
Status /Document/RtrAcct/RptOrErr/AcctRpt/AcctOrErr/Acct/MulBa	STLD

Message item	Utilisation
I/Sts	
Value Date Date /Document/RtrAcct/RptOrErr/AcctRpt/AcctOrErr/Acct/MulBa I/ValDt/Dt	2019-10-08
Processing Date Date /Document/RtrAcct/RptOrErr/AcctRpt/AcctOrErr/Acct/MulBa I/PrcgDt/Dt	2019-10-08
Multilateral Balance	
Amount /Document/RtrAcct/RptOrErr/AcctRpt/AcctOrErr/Acct/MulBa I/Amt	0.00
Credit Debit Indicator /Document/RtrAcct/RptOrErr/AcctRpt/AcctOrErr/Acct/MulBa I/CdtDbtInd	CRDT
Multilateral Balance Code /Document/RtrAcct/RptOrErr/AcctRpt/AcctOrErr/Acct/MulBa I/Tp/Cd	LTSF
Status /Document/RtrAcct/RptOrErr/AcctRpt/AcctOrErr/Acct/MulBa I/Sts	PDNG
Value Date Date /Document/RtrAcct/RptOrErr/AcctRpt/AcctOrErr/Acct/MulBa I/ValDt/Dt	2019-10-08
Processing Date Date /Document/RtrAcct/RptOrErr/AcctRpt/AcctOrErr/Acct/MulBa I/PrcgDt/Dt	2019-10-08
Multilateral Balance	
Amount /Document/RtrAcct/RptOrErr/AcctRpt/AcctOrErr/Acct/MulBa I/Amt	0.00
Credit Debit Indicator /Document/RtrAcct/RptOrErr/AcctRpt/AcctOrErr/Acct/MulBa	DBIT

Fehler! Verwenden Sie die Registerkarte 'Start', um dem Text zuzuweisen,

Message item	Utilisation
I/CdtDbtInd	
Multilateral Balance Code /Document/RtrAcct/RptOrErr/AcctRpt/AcctOrErr/Acct/MulBa I/Tp/Cd	LTSF
Status /Document/RtrAcct/RptOrErr/AcctRpt/AcctOrErr/Acct/MulBa I/Sts	PDNG
Value Date Date /Document/RtrAcct/RptOrErr/AcctRpt/AcctOrErr/Acct/MulBa I/ValDt/Dt	2019-10-08
Processing Date Date /Document/RtrAcct/RptOrErr/AcctRpt/AcctOrErr/Acct/MulBa I/PrcgDt/Dt	2019-10-08
Multilateral Balance	
Amount /Document/RtrAcct/RptOrErr/AcctRpt/AcctOrErr/Acct/MulBa I/Amt	0.00
Credit Debit Indicator /Document/RtrAcct/RptOrErr/AcctRpt/AcctOrErr/Acct/MulBa I/CdtDbtInd	CRDT
Multilateral Balance Code /Document/RtrAcct/RptOrErr/AcctRpt/AcctOrErr/Acct/MulBa I/Tp/Cd	PYMT
Status /Document/RtrAcct/RptOrErr/AcctRpt/AcctOrErr/Acct/MulBa I/Sts	STLD
Value Date Date /Document/RtrAcct/RptOrErr/AcctRpt/AcctOrErr/Acct/MulBa I/ValDt/Dt	2019-10-08
Processing Date Date /Document/RtrAcct/RptOrErr/AcctRpt/AcctOrErr/Acct/MulBa I/PrcgDt/Dt	2019-10-08

Message item	Utilisation
Multilateral Balance	
Amount /Document/RtrAcct/RptOrErr/AcctRpt/AcctOrErr/Acct/MulBa I/Amt	0.00
Credit Debit Indicator /Document/RtrAcct/RptOrErr/AcctRpt/AcctOrErr/Acct/MulBa I/CdtDbtInd	DBIT
Multilateral Balance Code /Document/RtrAcct/RptOrErr/AcctRpt/AcctOrErr/Acct/MulBa I/Tp/Cd	PYMT
Status /Document/RtrAcct/RptOrErr/AcctRpt/AcctOrErr/Acct/MulBa I/Sts	STLD
Value Date Date /Document/RtrAcct/RptOrErr/AcctRpt/AcctOrErr/Acct/MulBa I/ValDt/Dt	2019-10-08
Processing Date Date /Document/RtrAcct/RptOrErr/AcctRpt/AcctOrErr/Acct/MulBa I/PrcgDt/Dt	2019-10-08
Multilateral Balance	
Amount /Document/RtrAcct/RptOrErr/AcctRpt/AcctOrErr/Acct/MulBa I/Amt	0.00
Credit Debit Indicator /Document/RtrAcct/RptOrErr/AcctRpt/AcctOrErr/Acct/MulBa I/CdtDbtInd	CRDT
Multilateral Balance Code /Document/RtrAcct/RptOrErr/AcctRpt/AcctOrErr/Acct/MulBa I/Tp/Cd	PYMT
Status /Document/RtrAcct/RptOrErr/AcctRpt/AcctOrErr/Acct/MulBa I/Sts	PDNG

Message item	Utilisation
Value Date Date /Document/RtrAcct/RptOrErr/AcctRpt/AcctOrErr/Acct/MulBa I/ValDt/Dt	2019-10-08
Processing Date Date /Document/RtrAcct/RptOrErr/AcctRpt/AcctOrErr/Acct/MulBa I/PrcgDt/Dt	2019-10-08
Multilateral Balance	
Amount /Document/RtrAcct/RptOrErr/AcctRpt/AcctOrErr/Acct/MulBa I/Amt	0.00
Credit Debit Indicator /Document/RtrAcct/RptOrErr/AcctRpt/AcctOrErr/Acct/MulBa I/CdtDbtInd	DBIT
Multilateral Balance Code /Document/RtrAcct/RptOrErr/AcctRpt/AcctOrErr/Acct/MulBa I/Tp/Cd	PYMT
Status /Document/RtrAcct/RptOrErr/AcctRpt/AcctOrErr/Acct/MulBa I/Sts	PDNG
Value Date Date /Document/RtrAcct/RptOrErr/AcctRpt/AcctOrErr/Acct/MulBa I/ValDt/Dt	2019-10-08
Processing Date Date /Document/RtrAcct/RptOrErr/AcctRpt/AcctOrErr/Acct/MulBa I/PrcgDt/Dt	2019-10-08

Table 121 - ReturnAccount (camt.004) – usage case Request for account

Usage case example: camt.004_CLM_ReturnAccount_bs100.xml

Usage case: Get Account (Scenario 101)

In this example, CLM is responding to the business sender with the error information resulting from the validation failure of a camt.003 query.

The error being informed has a business rule code of E112', with a description 'Invalid search criteria'.

Message item	Utilisation
Message Identification /Document/RtrAcct/MsgHdr/MsgId	NONREF
Original Business Query /Document/RtrAcct/MsgHdr/OrgnIBizQry	Inc003b101-BAHId
Operational Error	
Error /Document/RtrAcct/RptOrErr/OprlErr/Err/Prtry	E112
Description /Document/RtrAcct/RptOrErr/OprlErr/Desc	Invalid search criteria

Table 122 - ReturnAccount (camt.004) – usage case Request for account with error response

Usage case example: camt.004_CLM_ReturnAccount_bs101.xml

Usage case: Return Account (Scenario 104)

In this example, CLM is responding to the business sender (CB) with the minimum reserve fulfilment information requested in the camt.003 message.

Message item	Utilisation
Message Identification /Document/RtrAcct/MsgHdr/MsgId	NONREF
Request Type /Document/RtrAcct/MsgHdr/ReqTp/Prtry/Id	MRFQ
Original Business Query /Document/RtrAcct/MsgHdr/OrgnIBizQry/MsgId	Inc003b104-BAHId
Account Report	
Account Identification /Document/RtrAcct/RptOrErr/AcctRpt/AcctId/Othr/Id	Leader Minimum Reserve Amounts
Currency /Document/RtrAcct/RptOrErr/AcctRpt/AcctOrErr/Acct/Ccy	EUR
Account Servicer /Document/RtrAcct/RptOrErr/AcctRpt/AcctOrErr/Acct/Svcr/ FinInstnId/BICFI	COBADEFFXXX

Message item	Utilisation
Multilateral Balance	
Amount /Document/RtrAcct/RptOrErr/AcctRpt/AcctOrErr/Acct/MulBa l/Amt	100000.00
Credit Debit Indicator /Document/RtrAcct/RptOrErr/AcctRpt/AcctOrErr/Acct/MulBa l/CdtDbtInd	CRDT
Multilateral Balance Code /Document/RtrAcct/RptOrErr/AcctRpt/AcctOrErr/Acct/MulBa l/Tp/Cd	BLCK
Value Date Date /Document/RtrAcct/RptOrErr/AcctRpt/AcctOrErr/Acct/MulBa l/ValDt/Dt	2019-10-08
Multilateral Balance	
Amount /Document/RtrAcct/RptOrErr/AcctRpt/AcctOrErr/Acct/MulBa l/Amt	2000.00
Credit Debit Indicator /Document/RtrAcct/RptOrErr/AcctRpt/AcctOrErr/Acct/MulBa l/CdtDbtInd	CRDT
Multilateral Balance Code /Document/RtrAcct/RptOrErr/AcctRpt/AcctOrErr/Acct/MulBa l/Tp/Cd	ADJT
Value Date Date /Document/RtrAcct/RptOrErr/AcctRpt/AcctOrErr/Acct/MulBa l/ValDt/Dt	2019-10-08
Multilateral Balance	
Amount /Document/RtrAcct/RptOrErr/AcctRpt/AcctOrErr/Acct/MulBa l/Amt	100500.00
Credit Debit Indicator /Document/RtrAcct/RptOrErr/AcctRpt/AcctOrErr/Acct/MulBa	CRDT

Message item	Utilisation
I/CdtDbtInd	
Multilateral Balance Code /Document/RtrAcct/RptOrErr/AcctRpt/AcctOrErr/Acct/MulBa I/Tp/Cd	PRAV
Value Date Date /Document/RtrAcct/RptOrErr/AcctRpt/AcctOrErr/Acct/MulBa I/ValDt/Dt	2019-10-08
Multilateral Balance	
Amount /Document/RtrAcct/RptOrErr/AcctRpt/AcctOrErr/Acct/MulBa I/Amt	20000.00
Credit Debit Indicator /Document/RtrAcct/RptOrErr/AcctRpt/AcctOrErr/Acct/MulBa I/CdtDbtInd	CRDT
Multilateral Balance Code /Document/RtrAcct/RptOrErr/AcctRpt/AcctOrErr/Acct/MulBa I/Tp/Cd	EXRE
Value Date Date /Document/RtrAcct/RptOrErr/AcctRpt/AcctOrErr/Acct/MulBa I/ValDt/Dt	2019-10-08
Multilateral Balance	
Amount /Document/RtrAcct/RptOrErr/AcctRpt/AcctOrErr/Acct/MulBa I/Amt	5000.00
Credit Debit Indicator /Document/RtrAcct/RptOrErr/AcctRpt/AcctOrErr/Acct/MulBa I/CdtDbtInd	CRDT
Multilateral Balance Code /Document/RtrAcct/RptOrErr/AcctRpt/AcctOrErr/Acct/MulBa I/Tp/Cd	EXRR
Value Date Date /Document/RtrAcct/RptOrErr/AcctRpt/AcctOrErr/Acct/MulBa	2019-10-08

Fehler! Verwenden Sie die Registerkarte 'Start', um dem Text zuzuweisen,

Message item	Utilisation
I/ValDt/Dt	
Account Report	
Account Identification /Document/RtrAcct/RptOrErr/AcctRpt/AcctId/Othr/Id	MDEEURCOBADEFFXXXXCOBADEFFXXX
Account Type /Document/RtrAcct/RptOrErr/AcctRpt/AcctOrErr/Acct/Tp/Cd	CACC
Currency /Document/RtrAcct/RptOrErr/AcctRpt/AcctOrErr/Acct/Ccy	EUR
Account Owner /Document/RtrAcct/RptOrErr/AcctRpt/AcctOrErr/Acct/Ownr/Id/OrgId/AnyBIC	COBADEFFXXX
Account Servicer /Document/RtrAcct/RptOrErr/AcctRpt/AcctOrErr/Acct/Svcr/FinInstnId/BICFI	COBADEFFXXX
Multilateral Balance	
Amount /Document/RtrAcct/RptOrErr/AcctRpt/AcctOrErr/Acct/MulBal/Amt	145000.00
Credit Debit Indicator /Document/RtrAcct/RptOrErr/AcctRpt/AcctOrErr/Acct/MulBal/CdtDbtInd	CRDT
Multilateral Balance Code /Document/RtrAcct/RptOrErr/AcctRpt/AcctOrErr/Acct/MulBal/Tp/Cd	CLSG
Value Date Date /Document/RtrAcct/RptOrErr/AcctRpt/AcctOrErr/Acct/MulBal/ValDt/Dt	2019-10-08

Table 123 - ReturnAccount (camt.004) – usage case Request for minimum reserve fulfilment information by a CB, with data response

Usage case example: camt.004_CLM_ReturnAccount_bs104.xml

Usage case: Return Account (Scenario 105)

In this example, CLM is responding to the business sender with the minimum reserve fulfilment information for the account requested in the camt.003 message.

Message item	Utilisation
Message Identification /Document/RtrAcct/MsgHdr/MsgId	NONREF
Request Type /Document/RtrAcct/MsgHdr/ReqTp/Prtry/Id	MRFQ
Original Business Query /Document/RtrAcct/MsgHdr/OrgnlBizQry/MsgId	Inc003b105-BAHId
Account Report	
Account Identification /Document/RtrAcct/RptOrErr/AcctRpt/AcctId/Othr/Id	MDEEURSOLADESTXXXSOLADESTXXX
Account Type /Document/RtrAcct/RptOrErr/AcctRpt/AcctOrErr/Acct/Tp/Cd	CACC
Currency /Document/RtrAcct/RptOrErr/AcctRpt/AcctOrErr/Acct/Ccy	EUR
Account Owner /Document/RtrAcct/RptOrErr/AcctRpt/AcctOrErr/Acct/Ownr/Id/OrgId/AnyBIC	SOLADESTXXX
Multilateral Balance	
Amount /Document/RtrAcct/RptOrErr/AcctRpt/AcctOrErr/Acct/MulBal/Amt	150000.00

Message item	Utilisation
Credit Debit Indicator /Document/RtrAcct/RptOrErr/AcctRpt/AcctOrErr/Acct/MulBa l/CdtDbtInd	CRDT
Multilateral Balance Code /Document/RtrAcct/RptOrErr/AcctRpt/AcctOrErr/Acct/MulBa l/Tp/Cd	CLSG
Value Date Date /Document/RtrAcct/RptOrErr/AcctRpt/AcctOrErr/Acct/MulBa l/ValDt/Dt	2019-10-08

Table 124 - ReturnAccount (camt.004) – usage case Request for minimum reserve fulfilment information by a non-lead participant, with data response

Usage case example: camt.004_CLM_ReturnAccount_bs105.xml

12.2.3 GetTransaction (camt.005)

12.2.3.1 Overview and scope of the message

This chapter illustrates the *GetTransaction* message.

The *GetTransaction* message is sent by a business sender to CLM. It is used to request information related to:

- | Payment (order)s linked to Central Banks Operations and Cash Withdrawals
- | Standing facility operations (Overnight deposit liquidity transfer order(s) and Marginal lending liquidity transfer order(s))
- | Other liquidity transfer order(s)

The message can be sent by the following business sender:

- | CLM Account Holder; A CLM Account Holder can query information on cash transfer (order)s concerning
 - its CLM cash accounts,
 - standing facility-related accounts (overnight deposit and marginal lending account), which are linked to the CLM Account Holder
- | Co-manager; A Co-manager can query cash transfer (order)s concerning
 - same CLM cash accounts as a CLM Account Holder (see list above),
 - CLM cash accounts of co-managed CLM Account Holder,

- standing facility-related accounts (overnight deposit and marginal lending account), which are linked to the co-managed CLM Account Holder

I CB; A CB can query cash transfer (order)s concerning

- its CLM cash accounts,
- CLM cash accounts of CLM Account Holders the CB is responsible for,
- CLM cash accounts, which are in the responsibility of another CB, but which are co-managed by a co-manager the CB is responsible for.

If the CB does not query for dedicated CLM cash account(s) by using <AccountOwner> or <AccountIdentification>, all cash transfer (order)s linked to all CLM account owners the CB is responsible for will be returned (national view). In consequence if a CB wants to query cash transfer (order)s which are settled on CLM cash accounts the CB is not responsible for, but which are in the data scope of the CB due to the responsibility for the co-manager, the CB has to indicate the CLM account owner or CLM cash account number(s) by using <AccountOwner> or <AccountIdentification>.

The usage of this message is to be found in chapter [Usage of Messages](#) [▶ 324].

The *GetTransaction* message also provides the possibility to perform a delta set request. The reported information is reduced to include only the modifications of cash transfer status relative to the previous delta set query. For detailed information please refer to chapter [Delta Set Retrieval Functionality](#) [▶ 357].

In response to the *GetTransaction* message, a [ReturnTransaction \(camt.006\)](#) [▶ 434] message containing either the requested information according to the specified search criteria or business validation error(s) is returned to the business sender.

12.2.3.2 Schema

Outline of the schema

The *GetTransaction* message is composed of the following message building blocks.

MessageHeader

This building block is mandatory and non-repetitive. It must contain an identification assigned by the sending party to uniquely and unambiguously identify the message. It also contains the initialise and query name parameters required for delta set reporting.

TransactionQueryDefinition

This building block is mandatory. It contains detailed information related to the business query criteria about the transaction.

SearchCriteria

It defines the criteria on which the information is extracted. It includes the following elements:

-
- | Account number
 - | Account owner
 - | Original Payment Cash transfer identifier reference
 - | Payment Requested execution date
 - | Status (including error code)
 - | Interbank settlement amount
 - | Currency
 - | Counterpart country
 - | Payment type
 - | Either Party BIC or Party Name Account Owner
 - | Priority
 - | Account Entry time
 - | Requested settlement time
 - | Debit or Credit indicator
 - | BIC of Business Sender
 - | BIC of Business Receiver
 - | BIC of Party
 - | Account Id of Debtor
 - | Account Id of Creditor
 - | File Reference

If more than one search criteria is used, the criteria are considered as an "AND"-operation. In case of multiple occurrences of a single search criteria (e.g. account number), each occurrence is considered as an "OR"-operation in combination with all other indicated search criteria considered to be an "AND"-operation.

References/links

The CLM-specific schema and documentation in XSD/Excel/PDF format as well as the message examples are provided outside of this document under the following link:

http://www.swift.com/mystandards/CLM/camt.005.001.08_CLM

Business rules applicable to the schema

For business rules applicable to *GetTransaction* refer to the chapter [Index of validation rules and error codes](#) [▶ 643].

12.2.3.3 The message in business context

Specific message requirements

All content must comply with the business rules for the message.

Message item	Utilisation
Message Header	
Message Identification /Document/GetTx/MsgHdr/MsgId	Value "NONREF" as the Message Id is already part of the BAH
Request Type /Document/GetTx/MsgHdr/ReqTp/Prtry/Id	For set-up of delta set retrieval requests the code "INIT" must be used. The code word "INIT" triggers the generation of a query name which is provided in element <QueryName> of the related query response message. The code "INIT" is also provided in the related response message of the delta set initialisation query.
Query Name /Document/GetTx/TxQryDef/TxCrit/QryNm	The query name recalls the criteria (search and return criteria) defined in the delta set initialisation query. The query name, which serves as an identifier for a delta set retrieval, is provided within the previously returned ReturnTransaction message element <QueryName>.
New Criteria	
Definition of search criteria on which the query is processed.	
New Criteria - Search Criteria	
<PmtTo>, <PmtFrom>, <PmtSch>, <AcctNtrySch> - when not stated all cash transfer (order)s debited or credited in the data scope of the business sender (see scope description of the message) will be selected.	
New Criteria - Search Criteria – Payment To	
The search criteria <PaymentTo> can be used to query cash transfer (order)s based on	
<ul style="list-style-type: none"> The business receiver provided in the BAH, i.e. only for cash transfer (order)s initiated via an A2A message or payment order(s) initiated via U2A Counterpart country code 	
Member Identification BIC /Document/GetTx/TxQryDef/TxCrit/NewCrit/SchCrit/PmtTo/Mmbld/FinInstnId/BICFI	BIC of the business Receiver (provided in BAH).
Member Identification LEI /Document/GetTx/TxQryDef/TxCrit/NewCrit/SchCrit/PmtTo/	If provided, this element is ignored by CLM

Message item	Utilisation
Mmbld/FinInstnld/LEI	
Country /Document/GetTx/TxQryDef/TxCrit/NewCrit/SchCrit/PmtTo/ Ctry	<p>Counterpart country code</p> <p>If <CdtDbtInd> is not used as search criteria, CLM uses the counterpart country code(s) as search criteria on the creditor side and on the debtor side. If CRDT is used in <CdtDbtInd> only the counterpart country on the debtor side and if DBIT is used in <CdtDbtInd> only the counterpart country on the creditor side are considered for the search.</p> <p>All CLM cash transfer (order)s, for which the indicated country code of the responsible CB of the cash transfer counterpart matches, are returned.</p> <p>The cash transfer counterpart is derived from:</p> <ul style="list-style-type: none"> the indicated account search criteria, if search criteria <AcctId> is used or the indicated party search criteria, if search criteria <AcctOwnr> is used or if business sender is an CLM Account Holder without search criteria <AcctId>. <p>For queries with business sender Co-manager or CB without search criteria <AcctOwnr> or <AcctId>, the cash transfer counterpart is derived only from accounts owned by the Co-manager itself (for Co-manager) or from all accounts the CB is responsible for (national scope for CB) and not for the entire data scope of the business sender Co-manager or CB.</p>
New Criteria - Search Criteria – Payment From	
<p>The search criteria <PaymentFrom> can be used to query cash transfer (order)s based on the business sender provided in the BAH, i.e. only for cash transfer (order)s initiated via an A2A message or payment order(s) initiated via U2A</p>	
Member Identification BIC /Document/GetTx/TxQryDef/TxCrit/NewCrit/SchCrit/PmtFr/ Mmbld/FinInstnld/BICFI	BIC of the business sender (provided in BAH).
Member Identification LEI /Document/GetTx/TxQryDef/TxCrit/NewCrit/SchCrit/PmtFr/ Mmbld/FinInstnld/LEI	If provided, this element is ignored by CLM
New Criteria - Search Criteria – Payment Search	

Message item	Utilisation
<p>Message Identification</p> <p>/Document/GetTx/TxQryDef/TxCrit/NewCrit/SchCrit/PmtSc h/MsgId</p>	<p>Payload Identifier from the BFH (in case the cash transfer order has been submitted in a file).</p>
<p>New Criteria - Search Criteria – Payment Search – Requested Execution Date</p> <p>Instructed date provided in the cash transfer (order).</p>	
<p>New Criteria - Search Criteria – Payment Search – Requested Execution Date – Date Search</p> <p>A choice between search criteria based on dates and date ranges.</p> <p>The query can be used for the current business day or for a business day in the future.</p>	
<p>From Date</p> <p>/Document/GetTx/TxQryDef/TxCrit/NewCrit/SchCrit/PmtSc h/ReqdExctnDt/DtSch/FrDt</p>	<p>Start date of the range.</p>
<p>To Date</p> <p>/Document/GetTx/TxQryDef/TxCrit/NewCrit/SchCrit/PmtSc h/ReqdExctnDt/DtSch/ToDt</p>	<p>End date of the range.</p>
<p>From To Date (Block)</p> <p>/Document/GetTx/TxQryDef/TxCrit/NewCrit/SchCrit/PmtSc h/ReqdExctnDt/DtSch/FrToDt</p>	<p>Particular time span specified between a start date and an end date.</p>
<p>Equal Date</p> <p>/Document/GetTx/TxQryDef/TxCrit/NewCrit/SchCrit/PmtSc h/ReqdExctnDt/DtSch/EqDt</p>	<p>Specified date to match.</p>
<p>New Criteria - Search Criteria – Payment Search – Payment Identification</p> <p>The search criteria <PaymentIdentification> can be used to query a single cash transfer (order).</p>	
<p>New Criteria - Search Criteria – Payment Search – Payment Identification – Long Business Identification</p> <p>The search criteria <Long BusinessIdentification> can be used to query a single payment (order) related to a pacs inbound message.</p>	
<p>UETR</p> <p>/Document/GetTx/TxQryDef/TxCrit/NewCrit/SchCrit/PmtSc h/PmtId/LngBizId/UETR</p>	<p>Universally unique identifier to provide an end-to-end reference of a payment transaction.</p>
<p>Interbank Settlement Amount</p> <p>/Document/GetTx/TxQryDef/TxCrit/NewCrit/SchCrit/PmtSc h/PmtId/LngBizId/IntrBkSttlmAmt</p>	<p>The instructed interbank settlement amount provided in the payment (order).</p>
<p>Interbank Settlement Date</p>	<p>The instructed date provided in the payment (order).</p>

Message item	Utilisation
/Document/GetTx/TxQryDef/TxCrit/NewCrit/SchCrit/PmtSc h/Pmtld/LngBizld/IntrBkSttlmDt	
Payment Method XML Message Name /Document/GetTx/TxQryDef/TxCrit/NewCrit/SchCrit/PmtSc h/Pmtld/LngBizld/PmtMtd/XMLMsgNm	XML message name identifier. Only the first 8 characters are considered by CLM, e.g. "pacs.009"
Instructing Agent BIC /Document/GetTx/TxQryDef/TxCrit/NewCrit/SchCrit/PmtSc h/Pmtld/LngBizld/InstgAgt/FinInstld/BICFI	Agent that instructs the next party in the chain to carry out the (set of) instruction(s).
Instructing Agent LEI /Document/GetTx/TxQryDef/TxCrit/NewCrit/SchCrit/PmtSc h/Pmtld/LngBizld/InstgAgt/FinInstld/LEI	If provided, this element is ignored by CLM
Instructed Agent BIC /Document/GetTx/TxQryDef/TxCrit/NewCrit/SchCrit/PmtSc h/Pmtld/LngBizld/InstdAgt/FinInstld/BICFI	Agent that is instructed by the previous party in the chain to carry out the (set of) instruction(s).
Instructed Agent LEI /Document/GetTx/TxQryDef/TxCrit/NewCrit/SchCrit/PmtSc h/Pmtld/LngBizld/InstdAgt/FinInstld/LEI	If provided, this element is ignored by CLM
End To End Identification /Document/GetTx/TxQryDef/TxCrit/NewCrit/SchCrit/PmtSc h/Pmtld/LngBizld/EndToEndld	Unique identification, as assigned by the initiating party, to unambiguously identify the transaction. This identification is passed on, unchanged, throughout the entire end-to-end chain.
Proprietary Identification /Document/GetTx/TxQryDef/TxCrit/NewCrit/SchCrit/PmtSc h/Pmtld/Prtyld	Booking reference/cash transfer identifier of the cash transfer (order) assigned by CLM.
New Criteria - Search Criteria – Payment Search – Status	
New Criteria - Search Criteria – Payment Search – Status – Payment Instruction Status	
The search criteria <PaymentInstructionStatus> can be used to query a cash transfer (order)s with certain pending or final status. Choice amongst <PdgSts>, <FnlSts> and <PdgAndFnlSts> is enabled.	
Pending Status /Document/GetTx/TxQryDef/TxCrit/NewCrit/SchCrit/PmtSc h/Sts/PmtInstrSts/PdgSts	<ul style="list-style-type: none"> ACPD - Related UDFS Status: Warehoused STLE - Related UDFS Status: Earmarked PSTL - Related UDFS Status: Queued
Final Status	Qualifies further the final status.

Message item	Utilisation
/Document/GetTx/TxQryDef/TxCrit/NewCrit/SchCrit/PmtSc h/Sts/PmtInstrSts/FnlSts	<ul style="list-style-type: none"> CAND = Revoked STLD = Settled RJTD = Rejected
Pending And Final Status /Document/GetTx/TxQryDef/TxCrit/NewCrit/SchCrit/PmtSc h/Sts/PmtInstrSts/PdgAndFnlSts	Codes of search criteria <PendingAndFinalStatus> represent superior code set for search criteria <PendingStatus> and <FinalStatus>. Code PDNG represents superior code set for search criteria <PendingStatus> codes <ul style="list-style-type: none"> ACPD - Related UDFS Status: Warehoused STLE - Related UDFS Status: Earmarked PSTL - Related UDFS Status: Queued Code FINL represents superior code set for search criteria <FinalStatus> codes <ul style="list-style-type: none"> CAND = Revoked STLD = Settled RJTD = Rejected
Proprietary Status Reason /Document/GetTx/TxQryDef/TxCrit/NewCrit/SchCrit/PmtSc h/Sts/PrtryStsRsn	The alpha numeric Error Code provided in the return message in response to the cash transfer order. The search on error code is only possible for errors detected in the cash transfer execution processing (e.g. due to a cash transfer revocation). Errors detected in the inbound processing of the cash transfer order cannot be searched as no cash transfer entry is created for invalid inbound messages.
Search Criteria – Payment Search – Interbank Settlement Amount	
The instructed amount from: <ul style="list-style-type: none"> the payment order, the liquidity transfer order, the standing order liquidity transfer order as recorded in CRDM. 	
From Amount Boundary Amount /Document/GetTx/TxQryDef/TxCrit/NewCrit/SchCrit/PmtSc h/IntrBkSttImAmt/CcyAndAmtRg/Amt/FrAmt/BdryAmt	Lower boundary of a range of amount values.
From Amount Included	Indicates whether the boundary amount is included in the range of amount values.

Message item	Utilisation
/Document/GetTx/TxQryDef/TxCrit/NewCrit/SchCrit/PmtSc h/IntrBkSttlmAmt/CcyAndAmtRg/Amt/FrAmt/Incl	
To Amount Boundary Amount /Document/GetTx/TxQryDef/TxCrit/NewCrit/SchCrit/PmtSc h/IntrBkSttlmAmt/CcyAndAmtRg/Amt/ToAmt/BdryAmt	Upper boundary of a range of amount values.
To Amount Included /Document/GetTx/TxQryDef/TxCrit/NewCrit/SchCrit/PmtSc h/IntrBkSttlmAmt/CcyAndAmtRg/Amt/ToAmt/Incl	Indicates whether the boundary amount is included in the range of amount values.
From To Amount From Amount Boundary Amount /Document/GetTx/TxQryDef/TxCrit/NewCrit/SchCrit/PmtSc h/IntrBkSttlmAmt/CcyAndAmtRg/Amt/FrToAmt/FrAmt/Bdry Amt	Lower boundary of a range of amount values.
From To Amount From Amount Included /Document/GetTx/TxQryDef/TxCrit/NewCrit/SchCrit/PmtSc h/IntrBkSttlmAmt/CcyAndAmtRg/Amt/FrToAmt/FrAmt/Incl	Indicates whether the boundary amount is included in the range of amount values.
From To Amount To Amount Boundary Amount /Document/GetTx/TxQryDef/TxCrit/NewCrit/SchCrit/PmtSc h/IntrBkSttlmAmt/CcyAndAmtRg/Amt/FrToAmt/ToAmt/Bdry Amt	Upper boundary of a range of amount values.
From To Amount To Amount Included /Document/GetTx/TxQryDef/TxCrit/NewCrit/SchCrit/PmtSc h/IntrBkSttlmAmt/CcyAndAmtRg/Amt/Amt/FrToAmt/ToAmt/ ncl	Indicates whether the boundary amount is included in the range of amount values.
Equal Amount /Document/GetTx/TxQryDef/TxCrit/NewCrit/SchCrit/PmtSc h/IntrBkSttlmAmt/CcyAndAmtRg/Amt/EQAmt	Exact value an amount must match to be considered valid.
Currency /Document/GetTx/TxQryDef/TxCrit/NewCrit/SchCrit/PmtSc h/IntrBkSttlmAmt/CcyAndAmtRg/Ccy	Medium of exchange of value, used to qualify an amount.
Payment Method XML Message Name /Document/GetTx/TxQryDef/TxCrit/NewCrit/SchCrit/PmtSc h/PmtId/PmtMtd/XMLMsgNm	Must contain the XML message name identifier. Only the first 8 characters are considered by RTGS, eg. "pacs.009"
Payment Method Proprietary	One of the following code values must be used:

Message item	Utilisation
/Document/GetTx/TxQryDef/TxCrit/NewCrit/SchCrit/PmtSc h/PmtId/PmtMtd/Prty	<ul style="list-style-type: none"> INTERN (INTERN) System-generated cash transfer (order)s (e.g. standing order LT) and inter-service LT(s) from other settlement services. TASK - Cash transfer (order)s generated by tasks entered via U2A.
Payment Type Proprietary /Document/GetTx/TxQryDef/TxCrit/NewCrit/SchCrit/PmtSc h/PmtTp/Prty	Please find the code list in UDFS section Cash Transfer Category and Business Case Codes for various features [▶ 172].
<p>Search Criteria – Payment Search – Processing Validity Time</p> <p>Can be used to define the search criteria for timed payment(s).</p> <p>The element <Instruction> must be used to define the settlement time request type, i.e. payment (order)s:</p> <p>earliest execution time (From Time) = TFRO</p> <p>latest execution time (Till Time or Reject Time) = TTIL</p> <p>The multiplicity of this element must be the same as <Instruction>.</p>	
From Date Time /Document/GetTx/TxQryDef/TxCrit/NewCrit/SchCrit/PmtSc h/PrcgVldyTm/FrDtTm	Lower included boundary timestamp for settlement time request type indicated in <Instr>.
To Date Time /Document/GetTx/TxQryDef/TxCrit/NewCrit/SchCrit/PmtSc h/PrcgVldyTm/ToDtTm	Upper included boundary timestamp for settlement time request type indicated in <Instr>.
Date Time Range From Date Time /Document/GetTx/TxQryDef/TxCrit/NewCrit/SchCrit/PmtSc h/PrcgVldyTm/DtTmRg/FrDtTm	Lower included boundary timestamp for settlement time request type indicated in <Instr>.
Date Time Range To Date Time /Document/GetTx/TxQryDef/TxCrit/NewCrit/SchCrit/PmtSc h/PrcgVldyTm/DtTmRg/ToDtTm	Upper included boundary timestamp for settlement time request type indicated in <Instr>.
Instruction /Document/GetTx/TxQryDef/TxCrit/NewCrit/SchCrit/PmtSc h/Instr	<p>Must be used in combination with <ProcessingValidityTime> to query for timed payment (order)s provided with latest debit time or earliest debit time.</p> <p>The multiplicity of this element must be the same as <ProcessingValidityTime>.</p>

Message item	Utilisation
	TFRO - Earliest execution time (From Time) TTIL - Latest execution time (Reject Time)
Interbank Settlement Date /Document/GetTx/TxQryDef/TxCrit/NewCrit/SchCrit/PmtSch/IntrBkSttlmDt	Date of CLM business day for settlement of the cash transfer (order)s.
End To End Identification /Document/GetTx/TxQryDef/TxCrit/NewCrit/SchCrit/PmtSch/EndToEndId	End To End Identification of the cash transfer (order). Standing Order Identification of the underlying standing order liquidity transfer defined by the CLM Account Holder in CRDM. Floor/Ceiling Order Identification of the underlying floor/ceiling liquidity transfer defined by the CLM Account Holder in CRDM. Business case ID in case of other system-generated cash transfer (order)s.
Search Criteria – Payment Search – Parties	
Instructing Agent BIC Document/GetTx/TxQryDef/TxCrit/NewCrit/SchCrit/PmtSch/Pties/InstgAgt/FinInstnId/BICFI	Can be used for search of <InstructingAgent> in case of payment (order)s
Instructed Agent BIC Document/GetTx/TxQryDef/TxCrit/NewCrit/SchCrit/PmtSch/Pties/InstdAgt/FinInstnId/BICFI	Can be used for search of <InstructedAgent> in case of payment (order)s
Search Criteria – Payment Search – Parties – Debtor	
Can be used either for search of	
<ul style="list-style-type: none"> BIC of <Debtor> if used in the cash transfer (order)s, Account number from <DebtorAccount> in case of liquidity transfer (order)s. 	
Debtor BIC /Document/GetTx/TxQryDef/TxCrit/NewCrit/SchCrit/PmtSch/Pties/Dbtr/Pty/Id/OrgId/AnyBIC	Can be used for search of BIC of <Debtor> if used in the cash transfer (order)s.
Debtor LEI Document/GetTx/TxQryDef/TxCrit/NewCrit/SchCrit/PmtSch/Pties/Dbtr/Pty/Id/OrgId/LEI	If provided, this element is ignored by CLM
Debtor Identification	Can be used for search of account number from <DebtorAccount> in case of liquidity transfer (order)s.

Message item	Utilisation
/Document/GetTx/TxQryDef/TxCrit/NewCrit/SchCrit/PmtSch/Pties/Dbtr/Pty/Id/OrgId/Othr/Id	
Search Criteria – Payment Search – Parties – Creditor Can be used either for search of <ul style="list-style-type: none"> BIC of <Creditor> if used in the cash transfer (order)s, Account number from <CreditorAccount> in case of liquidity transfer (order)s. 	
Creditor BIC Document/GetTx/TxQryDef/TxCrit/NewCrit/SchCrit/PmtSch/Pties/Cdtr/Pty/Id/OrgId/AnyBIC	Can be used for search of BIC of <Creditor> if used in the cash transfer (order)s.
Creditor LEI /Document/GetTx/TxQryDef/TxCrit/NewCrit/SchCrit/PmtSch/Pties/Cdtr/Pty/Id/OrgId/LEI	If provided, this element is ignored by CLM
Creditor Identification /Document/GetTx/TxQryDef/TxCrit/NewCrit/SchCrit/PmtSch/Pties/Cdtr/Pty/Id/OrgId/Othr/Id	Can be used for search of account number from <CreditorAccount> in case of liquidity transfer (order)s.
Search Criteria – Account Entry Search	
Account Identification /Document/GetTx/TxQryDef/TxCrit/NewCrit/SchCrit/AcctNtrySch/AcctId/EQ/Othr/Id	Debtor or creditor CLM cash account number(s) of the cash transfer (order)s within the data scope of the business sender.
Search Criteria – Payment Search – Entry Amount Search Criteria <EntryAmount> can be used for search of a certain amount posted on the CLM cash account.	
From Amount Boundary Amount /Document/GetTx/TxQryDef/TxCrit/NewCrit/SchCrit/PmtSch/NtryAmt/CcyAndAmtRg/Amt/FrAmt/BdryAmt	Lower boundary of a range of amount values. Amount value of the range limit.
From Amount Included /Document/GetTx/TxQryDef/TxCrit/NewCrit/SchCrit/PmtSch/NtryAmt/CcyAndAmtRg/Amt/FrAmt/Incl	Lower boundary of a range of amount values. Indicates whether the boundary amount is included in the range of amount values.
To Amount Boundary Amount /Document/GetTx/TxQryDef/TxCrit/NewCrit/SchCrit/PmtSch/NtryAmt/CcyAndAmtRg/Amt/ToAmt/BdryAmt	Upper boundary of a range of amount values. Amount value of the range limit.
To Amount Included /Document/GetTx/TxQryDef/TxCrit/NewCrit/SchCrit/PmtSch	Upper boundary of a range of amount values. Indicates whether the boundary amount is included in the range of

Message item	Utilisation
h/NtryAmt/CcyAndAmtRg/Amt/ToAmt/Incl	amount values.
From To Amount From Amount Boundary Amount /Document/GetTx/TxQryDef/TxCrit/NewCrit/SchCrit/PmtSc h/NtryAmt/CcyAndAmtRg/Amt/FrToAmt/FrAmt/BdryAmt	Lower boundary of a range of amount values. Amount value of the range limit.
From To Amount From Amount Included /Document/GetTx/TxQryDef/TxCrit/NewCrit/SchCrit/PmtSc h/NtryAmt/CcyAndAmtRg/Amt/FrToAmt/FrAmt/Incl	Lower boundary of a range of amount values. Indicates whether the boundary amount is included in the range of amount values.
From To Amount To Amount Boundary Amount /Document/GetTx/TxQryDef/TxCrit/NewCrit/SchCrit/PmtSc h/NtryAmt/CcyAndAmtRg/Amt/FrToAmt/ToAmt/BdryAmt	Upper boundary of a range of amount values. Amount value of the range limit.
From To Amount To Amount Included /Document/GetTx/TxQryDef/TxCrit/NewCrit/SchCrit/PmtSc h/NtryAmt/CcyAndAmtRg/Amt/Amt/FrToAmt/ToAmt/Incl	Upper boundary of a range of amount values. Indicates whether the boundary amount is included in the range of amount values.
Equal Amount /Document/GetTx/TxQryDef/TxCrit/NewCrit/SchCrit/PmtSc h/NtryAmt/CcyAndAmtRg/Amt/EQAmt	Exact value an amount must match to be considered valid.
Credit Debit Indicator /Document/GetTx/TxQryDef/TxCrit/NewCrit/SchCrit/PmtSc h/CdtDbtInd	<p>All CLM cash transfer (order)s, for which the indicated credit debit indicator matches, are returned.</p> <p>The credit debit indicator refers to one or multiple accounts derived from:</p> <ul style="list-style-type: none"> the indicated account search criteria, if search criteria <AcctId> is used or the indicated party search criteria, if search criteria <AcctOwnr> is used or if business sender is an CLM Account Holder without search criteria <AcctId>. <p>For queries with business sender co-manager or CB without search criteria <AcctOwnr> or <AcctId>, the credit debit indicator refers only to accounts owned by the co-manager or the CB itself and not for the entire data scope of the business sender co-manager or CB.</p>
Entry Date (Block) /Document/GetTx/TxQryDef/TxCrit/NewCrit/SchCrit/NtryDt	Search Criteria <EntryDate> can be used to search for posting(s) on CLM cash account by using time parameter (indicated boundary timestamps are always included in the search).

Message item	Utilisation
Account Owner BIC /Document/GetTx/TxQryDef/TxCrit/NewCrit/SchCrit/AcctOwnr/Id/OrgId/AnyBIC	BIC of the Party.
Account Owner LEI /Document/GetTx/TxQryDef/TxCrit/NewCrit/SchCrit/AcctNtrySch/AcctOwnr/Id/OrgId/LEI	If provided, this element is ignored by CLM.
<p>Return Criteria</p> <p>The block <ReturnCriteria> can be used to define the information to be reported in the query response.</p> <p>If the block <ReturnCriteria> is not used, all elements provided within <ReturnCriteria> block are provided in the query response (default value is "true" for all indicators).</p> <p>If one or several indicator(s) in block <ReturnCriteria> are set to "true", only those ReturnCriteria are provided in the query response which are set to "true".</p> <p>If one or several indicator(s) in block <ReturnCriteria> are set to "false", only those ReturnCriteria are provided in the query response which are not set to "false".</p> <p>In case one or several indicators in block <ReturnCriteria> are set to "true" and others are set to "false", only the indicators set to "true" are considered in the way described above.</p>	
<p>Return Criteria – Payment To Return</p>	
Payment To Return Member Identification Indicator /Document/GetTx/TxQryDef/TxCrit/NewCrit/RtrCrit/PmtToRtrCrit/MmbldInd	Indicator is used to query the BIC of the business receiver of the cash transfer.
Payment To Return Country Identification Indicator /Document/GetTx/TxQryDef/TxCrit/NewCrit/RtrCrit/PmtToRtrCrit/CtryIdInd	Indicator is used to query the counterpart country of the cash transfer.
<p>Return Criteria – Payment From Return</p>	
Payment From Return Criteria Member Identification /Document/GetTx/TxQryDef/TxCrit/NewCrit/RtrCrit/PmtFrRtrCrit/MmbldInd	Indicator is used to query the BIC of the business sender of the cash transfer.
<p>Return Criteria – Account Cash Entry Return Criteria</p>	
Entry Amount Indicator /Document/GetTx/TxQryDef/TxCrit/NewCrit/RtrCrit/AcctCshNtryRtrCrit/NtryAmtInd	Indicator is used to query the posted amount of the cash transfer.
Entry Date Indicator	Indicator is used to query the booking date and time of the cash transfer.

Message item	Utilisation
/Document/GetTx/TxQryDef/TxCrit/NewCrit/RtrCrit/AcctCshNtryRtrCrit/NtryDtInd	
Account Owner Indicator /Document/GetTx/TxQryDef/TxCrit/NewCrit/RtrCrit/AcctCshNtryRtrCrit/AcctOwnrInd	Indicator is used to query the BIC of the account owner.
Return Criteria – Payment Return Criteria	
Message Identification Indicator /Document/GetTx/TxQryDef/TxCrit/NewCrit/RtrCrit/PmtRtrCrit/MsgIdInd	Indicator is used to query the file reference of the BFH of the file in which the cash transfer order has been submitted (if a file has been used).
Requested Execution Date Indicator /Document/GetTx/TxQryDef/TxCrit/NewCrit/RtrCrit/PmtRtrCrit/ReqExctnDtInd	Indicator is used to query the requested execution date of the cash transfer order.
Return Criteria – Payment Return Criteria – Instruction Status Return Criteria	
Payment Instruction Status Indicator /Document/GetTx/TxQryDef/TxCrit/NewCrit/RtrCrit/PmtRtrCrit/InstrStsRtrCrit/PmtInstrStsInd	Indicator is used to query the pending or final status of a cash transfer (order).
Payment Instruction Status Date Time Indicator /Document/GetTx/TxQryDef/TxCrit/NewCrit/RtrCrit/PmtRtrCrit/InstrStsRtrCrit/PmtInstrStsDtTmInd	Indicator is used to query the date and time where the final status of a settled cash transfer (order) was reached.
Payment Instruction Status Reason Indicator /Document/GetTx/TxQryDef/TxCrit/NewCrit/RtrCrit/PmtRtrCrit/InstrStsRtrCrit/PmtInstrStsRsnInd	If <PaymentInstructionStatusReasonIndicator> is not provided, default value is "true"
Interbank Settlement Amount Indicator /Document/GetTx/TxQryDef/TxCrit/NewCrit/RtrCrit/PmtRtrCrit/IntrBkSttlmAmtInd	Indicator is used to query the instructed amount for settlement in CLM.
Processing Validity Time Indicator /Document/GetTx/TxQryDef/TxCrit/NewCrit/RtrCrit/PmtRtrCrit/PrcgVldtyTmInd	Indicator is used to query the date and time range requested for settlement in CLM.
Instruction Copy Indicator /Document/GetTx/TxQryDef/TxCrit/NewCrit/RtrCrit/PmtRtrCrit/InstrCpyInd	Indicator is used to request a copy of a cash transfer (order), i.e. Payment and liquidity transfer (order): <BAH> (without signature) and <Document>
Payment Type Indicator	Indicator is used to query the cash transfer (order) type.

Message item	Utilisation
/Document/GetTx/TxQryDef/TxCrit/NewCrit/RtrCrit/PmtRtrC rit/PmtTpInd	
Interbank Settlement Date Indicator /Document/GetTx/TxQryDef/TxCrit/NewCrit/RtrCrit/PmtRtrC rit/IntrBkSttlmDtInd	Indicator is used to query the interbank settlement date of cash transfer (order).
End To End Identification Indicator /Document/GetTx/TxQryDef/TxCrit/NewCrit/RtrCrit/PmtRtrC rit/EndToEndIdInd	Indicator is used to query the end to end ID of cash transfer (order).
Payment Method Indicator /Document/GetTx/TxQryDef/TxCrit/NewCrit/RtrCrit/PmtRtrC rit/PmtMtdInd	Indicator is used to query the cash transfer (order) origin.
Debtor Indicator /Document/GetTx/TxQryDef/TxCrit/NewCrit/RtrCrit/PmtRtrC rit/DbtrInd	Indicator is used to query either <ul style="list-style-type: none"> the debtor BIC provided in the payment (order), the debtor cash account number provided in the liquidity transfer (order).
Creditor Indicator /Document/GetTx/TxQryDef/TxCrit/NewCrit/RtrCrit/PmtRtrC rit/CdtrInd	Indicator is used to query either <ul style="list-style-type: none"> the creditor BIC provided in the payment (order), the creditor cash account number provided in the liquidity transfer (order).

Table 125 - GetTransaction (camt.005)

Usage case: Delta set reporting query (Initialise) camt.005 (Scenario 077)

In this example, the business sender is requesting information for all transactions on MCA (Id: MDEEURSOLADESTXXXSOLADESTXXX). For the purposes of this scenario, this message was sent at 09:00 on 25th August, 2021. The query also includes the type INIT indicating that CLM should use this search criteria to initialise and save a delta set for subsequent delta requests.

Message item	Utilisation
Message Identification /Document/GetTx/MsgHdr/MsgId	NONREF
Request Type /Document/GetTx/MsgHdr/ReqTp/Prtry/Id	INIT
Account Identification	MDEEURSOLADESTXXXSOLADESTXXX

Message item	Utilisation
/Document/GetTx/TxQryDef/TxCrit/NewCrit/SchCrit/AcctNtrySch/AcctId/EQ/Othr/Id	
Payment Instruction Status Indicator /Document/GetTx/TxQryDef/TxCrit/NewCrit/RtrCrit/PmtRtrCrit/InstrStsRtrCrit/PmtInstrStsInd	true
Interbank Settlement Amount Indicator /Document/GetTx/TxQryDef/TxCrit/NewCrit/RtrCrit/PmtRtrCrit/IntrBkSttlmAmtInd	true
End To End Identification Indicator /Document/GetTx/TxQryDef/TxCrit/NewCrit/RtrCrit/PmtRtrCrit/EndToEndIdInd	true

Table 126 - GetTransaction (camt.005) – usage case delta set query - initialisation (Scenario 077)

Usage case example: camt.005_CLM_GetTransaction_INIT_bs077.xml

Usage case: Delta set reporting query (first delta query) camt.005 (Scenario 077)

In this example, the business sender is requesting a delta report update based upon a previously initiated delta set with the name “CLMDELTA-b077”.

All search and response criteria are taken from the previously initiated delta set stored in CLM.

For the purposes of this scenario, this message was sent at 10:00 on 25th August, 2021.

Message item	Utilisation
Message Identification /Document/GetTx/MsgHdr/MsgId	NONREF
Query Name /Document/GetTx/TxQryDef/TxCrit/QryNm	CLMDELTA-b077

Table 127 - GetTransaction (camt.005) – usage case delta set query – first delta query (Scenario 077)

Usage case example: camt.005_CLM_GetTransaction_DLT1_bs077.xml

Usage case: Delta set reporting query (second delta query) camt.005 (Scenario 077)

In this example, the business sender is requesting a delta report update based upon a previously initiated delta set with the name “CLMDELTA-b077”.

All search and response criteria are taken from the previously initiated delta set stored in CLM.

The expected result will also take into consideration all previous delta queries since initialisation.

For the purposes of this scenario, this message was sent at 11:00 on 25th August, 2021.

Message item	Utilisation
Message Identification /Document/GetTx/MsgHdr/MsgId	NONREF
Query Name /Document/GetTx/TxQryDef/TxCrit/QryNm	CLMDELTA-b077

Table 128 - GetTransaction (camt.005) – usage case delta set query – second delta query (Scenario 077)

Usage case example: camt.005_CLM_GetTransaction_DLT2_bs077.xml

Usage case: Delta set reporting query (third delta query) camt.005 (Scenario 077)

In this example, the business sender is requesting a delta report update based upon a previously initiated delta set with the name “CLMDELTA-b077”.

All search and response criteria are taken from the previously initiated delta set stored in CLM.

The expected result will also take into consideration all previous delta queries since initialisation.

For the purposes of this scenario, this message was sent at 12:00 on 25th August, 2021.

Message item	Utilisation
Message Identification /Document/GetTx/MsgHdr/MsgId	NONREF
Query Name /Document/GetTx/TxQryDef/TxCrit/QryNm	CLMDELTA-b077

Table 129 - GetTransaction (camt.005) – usage case delta set query – third delta query (Scenario 077)

Usage case example: camt.005_CLM_GetTransaction_DLT3_bs077.xml

Usage case: CLM Get Transaction camt.005 (Scenario 102)

In this example, the request has no criteria but is sent from a CLM account holder (party BIC: COBADEFFXXX). The expectation is a response listing all transactions for the business day against all accounts owned by the sender. To make sense of the response data, this query was sent at 14:30 on October 8th, 2019.

Fehler! Verwenden Sie die Registerkarte 'Start', um dem Text zuzuweisen,

Message item	Utilisation
Message Header	
Message Identification /Document/GetTx/MsgHdr/MsgId	NONREF
New Criteria	
Return Criteria	
Entry Amount Indicator /Document/GetTx/TxQryDef/TxCrit/NewCrit/RtrCrit/AcctCsh NtryRtrCrit/NtryAmtInd	true
Entry Date Indicator /Document/GetTx/TxQryDef/TxCrit/NewCrit/RtrCrit/AcctCsh NtryRtrCrit/NtryDtInd	true
Account Owner Indicator /Document/GetTx/TxQryDef/TxCrit/NewCrit/RtrCrit/AcctCsh NtryRtrCrit/AcctOwnrInd	true
Return Criteria – Payment Return Criteria	
Payment Instruction Status Indicator /Document/GetTx/TxQryDef/TxCrit/NewCrit/RtrCrit/PmtRtrC rit/InstrStsRtrCrit/PmtInstrStsInd	true
Interbank Settlement Amount Indicator /Document/GetTx/TxQryDef/TxCrit/NewCrit/RtrCrit/PmtRtrC rit/IntrBkSttlmAmtInd	true
Payment Type Indicator /Document/GetTx/TxQryDef/TxCrit/NewCrit/RtrCrit/PmtRtrC rit/PmtTpInd	true
End To End Identification Indicator /Document/GetTx/TxQryDef/TxCrit/NewCrit/RtrCrit/PmtRtrC rit/EndToEndIdInd	true

Table 130 - GetTransaction (camt.005) – usage case Account holder requesting all transactions (Scenario 102)

Usage case example: camt.005_CLM_GetTransaction_bs102.xml

Usage case: CLM Get Transaction camt.005 (Scenario 103)

In this example, the business sender is requesting information for all transactions on MCA (Id: MDEEURSOLADESTXXXSOLADEST123). For the purposes of this scenario, this message was sent at 15:00 on 8th October, 2019.

Message item	Utilisation
Message Header	
Message Identification /Document/GetTx/MsgHdr/MsgId	NONREF
Search Criteria – Account Entry Search	
Account Identification /Document/GetTx/TxQryDef/TxCrit/NewCrit/SchCrit/AcctNtrySch/AcctId/EQ/Othr/Id	MDEEURSOLADESTXXXSOLADEST123

Table 131 - GetTransaction (camt.005) – usage case Request for transactions with error response (Scenario 103)

Usage case example: camt.005_CLM_GetTransaction_bs103.xml

Usage case: CLM Get Transaction camt.005 (Scenario 106)

In this example, the sending account owner (party BIC: SOLADESTXXX) is requesting details of a single transaction, identified by the End-to-end Id which was used on the original payment order. The expectation is a response showing just 3 basic pieces of information: amount, status and type (plus a repeat of the End-to-end Id).

To make sense of the response data, this query was sent at 09:00 on October 9th, 2019.

Message item	Utilisation
Message Header	
Message Identification /Document/GetTx/MsgHdr/MsgId	NONREF
New Criteria	
New Criteria - Search Criteria – Payment Search – Payment Identification	
End To End Identification /Document/GetTx/TxQryDef/TxCrit/NewCrit/SchCrit/PmtSch/PmtId/LngBizId/EndToEndId	Inp009b004-E2EId
Return Criteria	
Return Criteria – Payment Return Criteria – Instruction Status Return Criteria	

Message item	Utilisation
Payment Instruction Status Indicator /Document/GetTx/TxQryDef/TxCrit/NewCrit/RtrCrit/PmtRtrC rit/InstrStsRtrCrit/PmtInstrStsInd	true
Interbank Settlement Amount Indicator /Document/GetTx/TxQryDef/TxCrit/NewCrit/RtrCrit/PmtRtrC rit/IntrBkSttlmAmtInd	true
Payment Type Indicator /Document/GetTx/TxQryDef/TxCrit/NewCrit/RtrCrit/PmtRtrC rit/PmtTpInd	true
End To End Identification Indicator /Document/GetTx/TxQryDef/TxCrit/NewCrit/RtrCrit/PmtRtrC rit/EndToEndIdInd	true

Table 132 - GetTransaction (camt.005) – usage case Account holder requesting a single transaction (Scenario 106)

Usage case example: camt.005_CLM_GetTransaction_bs106.xml

Usage case: CLM Get Transaction camt.005 (Scenario 107)

In this example, the request has no criteria but is sent from a CB (party BIC: MARKDEFFXXX). The expectation is a response listing all transactions for the business day against all accounts within the sending CB's data scope. To make sense of the response data, this query was sent at 14:30 on October 8th, 2019.

Message item	Utilisation
Message Header	
Message Identification /Document/GetTx/MsgHdr/MsgId	NONREF
Return Criteria	
Return Criteria – Account Cash Entry Return Criteria	
Entry Amount Indicator /Document/GetTx/TxQryDef/TxCrit/NewCrit/RtrCrit/AcctCsh NtryRtrCrit/NtryAmtInd	true
Entry Date Indicator /Document/GetTx/TxQryDef/TxCrit/NewCrit/RtrCrit/AcctCsh NtryRtrCrit/NtryDtInd	true

Message item	Utilisation
Account Owner Indicator /Document/GetTx/TxQryDef/TxCrit/NewCrit/RtrCrit/AcctCsh NtryRtrCrit/AcctOwnrInd	true
Return Criteria – Payment Return Criteria	
Payment Instruction Status Indicator /Document/GetTx/TxQryDef/TxCrit/NewCrit/RtrCrit/PmtRtrC rit/InstrStsRtrCrit/PmtInstrStsInd	true
Interbank Settlement Amount Indicator /Document/GetTx/TxQryDef/TxCrit/NewCrit/RtrCrit/PmtRtrC rit/IntrBkSttlmAmtInd	true
Payment Type Indicator /Document/GetTx/TxQryDef/TxCrit/NewCrit/RtrCrit/PmtRtrC rit/PmtTpInd	true
End To End Identification Indicator /Document/GetTx/TxQryDef/TxCrit/NewCrit/RtrCrit/PmtRtrC rit/EndToEndIdInd	true

Table 133 - GetTransaction (camt.005) – usage case CB requesting all transactions (Scenario 107)

Usage case example: camt.005_CLM_GetTransaction_bs107.xml

Usage case: CLM Get Transaction camt.005 (Scenario 108)

In this example, the sending CB (party BIC: MARKDEFFXXX) is requesting details of a single transaction, identified by the End-to-end Id which was used on the original payment order. The expectation is a response showing every available piece of transaction-related information. To make sense of the response data, this query was sent at 09:00 on October 9th, 2019.

Message item	Utilisation
Message Header	
Message Identification /Document/GetTx/MsgHdr/MsgId	NONREF
End To End Identification /Document/GetTx/TxQryDef/TxCrit/NewCrit/SchCrit/PmtSc h/EndToEndId	Inp009b004-E2EId

Table 134 - GetTransaction (camt.005) – usage case CB requesting a single transaction with all fields (Scenario 108)

Usage case example: camt.005_CLM_GetTransaction_bs108.xml

Usage case: CLM Get Transaction camt.005 (Scenario 109)

In this example, a CB (party BIC: MARKDEFFXXX) is using the account criteria to specify a marginal lending account (acct id: LDEEURCOBADEFFXXX0001) with no other criteria. There are only 3 response fields defined to minimise the size of the response.

The expectation is a response listing all transactions for the business day against this account. To make sense of the response data, this query was sent at 16:30 on October 8th, 2019.

Message item	Utilisation
Message Header	
Message Identification /Document/GetTx/MsgHdr/MsgId	NONREF
Search Criteria – Account Entry Search	
Account Identification /Document/GetTx/TxQryDef/TxCrit/NewCrit/SchCrit/AcctNtrySch/AcctId/EQ/Othr/Id	LDEEURCOBADEFFXXX0001
Return Criteria	
Entry Amount Indicator /Document/GetTx/TxQryDef/TxCrit/NewCrit/RtrCrit/AcctCshNtryRtrCrit/NtryAmtInd	true
Entry Date Indicator /Document/GetTx/TxQryDef/TxCrit/NewCrit/RtrCrit/AcctCshNtryRtrCrit/NtryDtInd	true
Return Criteria – Payment Return Criteria	
Payment Type Indicator /Document/GetTx/TxQryDef/TxCrit/NewCrit/RtrCrit/PmtRtrCrit/PmtTpInd	true

Table 135 - GetTransaction (camt.005) – usage case CB requesting marginal lending accounts (Scenario 109)

Usage case example: camt.005_CLM_GetTransaction_bs109.xml

12.2.4 ReturnTransaction (camt.006)

12.2.4.1 Overview and scope of the message

This chapter illustrates the *ReturnTransaction* message.

The *ReturnTransaction* message is sent by CLM in response to a [GetTransaction \(camt.005\)](#) [▶ 411] message. It is used to provide the requested information on the details of one or more liquidity transfer (order)s and/or payment (order)s according to the specified search criteria.

The usage of this message is to be found in chapter [Usage of Messages](#) [▶ 324].

In the case of business validation error(s) on the [GetTransaction](#) [▶ 411] query, CLM sends the *ReturnTransaction* message containing the respective error code(s) and error description(s) to the business receiver.

In case of pagination, [ReceiptAcknowledgement \(admi.007\)](#) [▶ 370] message is used to inform the business sender of the Cash transfer query about pagination and the respective switch to store-n-forward network service. Additionally the respective query response is provided via store-n-forward network service.

In the case of the use of delta set retrieval functionality, the reported information is reduced to include only the modifications of cash transfer order status relative to the previous delta set query. For detailed information please refer to chapter [Delta Set Retrieval Functionality](#) [▶ 357].

12.2.4.2 Schema

Outline of the schema

The *ReturnTransaction* message is composed of the following message building blocks.

MessageHeader

This building block is mandatory and non-repetitive. It contains an identification assigned by the sending party to uniquely and unambiguously identify the message. It also contains the initialise and queryname information required for delta set reporting.

ReportOnError

This building block is mandatory and non-repetitive. It contains either the information matching the search criteria of the related business query about transactions, or an error indication.

TransactionReport

This building block is mandatory and repetitive. It reports either on the transaction information or on a business error. When it reports the transaction information, it may contain:

- l payment identification;

- | payment to;
- | payment from;
- | debit/credit indicator;
- | account;
- | entry date;
- | payment details: status, instructed amount, interbank settlement amount, payment method, processing validity time, payment type, debtor, debtor agent, intermediary agent, creditor agent, creditor.

References/links

The CLM-specific schema and documentation in XSD/Excel/PDF format as well as the message examples are provided outside of this document under the following link:

http://www.swift.com/mystandards/CLM/camt.006.001.08_CLM

Business rules applicable to the schema

No business rules are applicable to a *ReturnTransaction* message.

12.2.4.3 The message in business context

Specific message contents

Message item	Utilisation
Message Header	
Message Identification /Document/RtrTx/MsgHdr/MsgId	Value "NONREF" as the Message Id is already part of the BAH
Message Pagination Page Number /Document/RtrTx/MsgHdr/MsgPgntn/PgNb	Sequence number of the <ReturnTransaction> message within the set of divided messages recurring to pagination.
Message Pagination Last Page Indicator /Document/RtrTx/MsgHdr/MsgPgntn/LastPgInd	Indicator for last <ReturnTransaction> message within the set of divided messages recurring to pagination.
Original Business Query /Document/RtrTx/MsgHdr/OrgnlBizQry/MsgId	Copy of BAH MsgId of the related <GetTransaction> message.
Request Type /Document/RtrTx/MsgHdr/ReqTp/Prtry/Id	The code "INIT" is provided only in response of the delta set initialisation query.
Query Name /Document/RtrTx/MsgHdr/QryNm	The query name is provided only for delta set requests.

Message item	Utilisation
<p>Business Report – Transaction Report</p> <p>If the debit and credit leg of a cash transfer (order) are within the data scope of the business sender and within the result set of the query response according to the used search criteria in the query, the related cash transfer (order) is returned twice via repetitive <TxRpt>, i.e. one <TxRpt> for the debited and one <TxRpt> for the credited CLM cash accounts. The matching of both cash transfer legs is ensured by the returned booking reference/cash transfer identifier in element <PaymentIdentification/ProprietaryIdentification>.</p>	
<p>Payment Identification /Document/RtrTx/RptOrErr/BizRpt/TxRpt/PmtId/PrtryId</p>	<p>Booking reference/CLM cash transfer identifier of the cash transfer (order) assigned by CLM.</p>
<p>Business Report – Transaction Report – Transaction – Payment To</p> <p>The transaction information <PaymentTo> provides:</p> <ul style="list-style-type: none"> the business receiver indicated in the BAH of the cash transfer (order), i.e. only for cash transfer (order)s initiated via an A2A message or payment order(s) initiated via U2A the counterpart country code of the cash transfer (order) related to the reported cash account. 	
<p>Payment To BIC /Document/RtrTx/RptOrErr/BizRpt/TxRpt/TxOrErr/Tx/PmtTo /Mmbld/FinInstnld/BICFI</p>	<p>BIC of business receiver provided in the BAH. It is always the CLM system BIC.</p>
<p>Payment To LEI /Document/RtrTx/RptOrErr/BizRpt/TxRpt/TxOrErr/Tx/PmtTo /Mmbld/FinInstnld/LEI</p>	<p>Not provided by CLM</p>
<p>Payment To Country /Document/RtrTx/RptOrErr/BizRpt/TxRpt/TxOrErr/Tx/PmtTo /Ctry</p>	<p>Counterpart country code of the cash transfer related to the reported debited or credited cash account.</p>
<p>Business Report – Transaction Report – Transaction – Payment From</p> <p>The transaction information <PaymentFrom> provides the business sender indicated in the BAH of the cash transfer (order), i.e. only for cash transfer (order)s initiated via an A2A message or payment order(s) initiated via U2A.</p>	
<p>Payment From BIC /Document/RtrTx/RptOrErr/BizRpt/TxRpt/TxOrErr/Tx/PmtFr /Mmbld/FinInstnld/BICFI</p>	<p>BIC of business sender provided in the BAH.</p>
<p>Payment From LEI /Document/RtrTx/RptOrErr/BizRpt/TxRpt/TxOrErr/Tx/PmtFr /Mmbld/FinInstnld/LEI</p>	<p>Not provided by CLM</p>
<p>Credit Debit Indicator /Document/RtrTx/RptOrErr/BizRpt/TxRpt/TxOrErr/Tx/CdtDb</p>	<p>Indicates whether the cash transfer (order) is a credit or a debit for the reported cash account.</p>

Message item	Utilisation
tlnd	<ul style="list-style-type: none"> CRDT- posting is an increase. DBIT - posting is a decrease.
Business Report – Transaction Report – Transaction – Payment	
<p>Message Identification</p> <p>/Document/RtrTx/RptOrErr/BizRpt/TxRpt/TxOrErr/Tx/Pmt/MsgId</p>	<p>Provides the payload Identifier from the BFH in which the cash transfer (order) was submitted (only provided in case the cash transfer order has been submitted in a file).</p>
<p>Requested Execution Date</p> <p>/Document/RtrTx/RptOrErr/BizRpt/TxRpt/TxOrErr/Tx/Pmt/ReqdExctnDt/Dt</p>	<p>Provides the instructed date in the cash transfer order.</p>
<p>Status Code Pending</p> <p>/Document/RtrTx/RptOrErr/BizRpt/TxRpt/TxOrErr/Tx/Pmt/Status/Cd/Pdg</p>	<ul style="list-style-type: none"> ACPD = Related UDFS Status: Warehoused STLE = Related UDFS Status: Earmarked PSTL = Related UDFS Status: Pending
<p>Status Code Final</p> <p>/Document/RtrTx/RptOrErr/BizRpt/TxRpt/TxOrErr/Tx/Pmt/Status/Cd/Fnl</p>	<ul style="list-style-type: none"> CAND =- Related UDFS Status: Revoked STLD =- Related UDFS Status: Settled (including Partially Settled) RJTD =- Related UDFS Status: Rejected
<p>Status Reason Proprietary Rejection Proprietary Status Reason</p> <p>/Document/RtrTx/RptOrErr/BizRpt/TxRpt/TxOrErr/Tx/Pmt/Status/Rsn/PrtryRjctn/PrtryStsRsn</p>	<p>Provides the error code of a rejected or revoked cash transfer order.</p>
<p>Status Reason Proprietary Rejection Reason</p> <p>/Document/RtrTx/RptOrErr/BizRpt/TxRpt/TxOrErr/Tx/Pmt/Status/Rsn/PrtryRjctn/Rsn</p>	<p>Provides the detailed error description.</p>
<p>Interbank Settlement Amount</p> <p>/Document/RtrTx/RptOrErr/BizRpt/TxRpt/TxOrErr/Tx/Pmt/InterBkSttlmAmt/AmtWthCcy</p>	<p>Amount instructed for settlement of a cash transfer (order). In case of partial execution of a cash transfer the amount posted on the reported account in <Ntry/Amt> deviates from this amount.</p>
<p>Payment Method XML Message Name</p> <p>/Document/RtrTx/RptOrErr/BizRpt/TxRpt/TxOrErr/Tx/Pmt/PmtMtd/XMLMsgNm</p>	<p>Provides the full XML message name identifier, e.g.: pacs.009.001.08</p>
<p>Payment Method Proprietary</p> <p>/Document/RtrTx/RptOrErr/BizRpt/TxRpt/TxOrErr/Tx/Pmt/PmtMtd/Prtry</p>	<p>One of the following code values must be used:</p> <ul style="list-style-type: none"> INTERN System-generated cash transfer (order)s (e.g. standing order LT) and inter-service LT(s) from other

Message item	Utilisation
	<p>settlement services.</p> <ul style="list-style-type: none"> TASK - Cash transfer (order)s generated by tasks entered via U2A.
<p>Business Report – Transaction Report – Transaction – Payment – Processing Validity Time</p> <p>Provides the timestamps for timed payment (order)s. If the timestamps of the cash transfer order were modified, the updated value will be returned.</p>	
<p>Processing Validity Time From Date Time /Document/RtrTx/RptOrErr/BizRpt/TxRpt/TxOrErr/Tx/Pmt/PrcgVldtyTm/FrDtTm</p>	<p>Provides the respective timestamp for earliest execution time (From Time).</p>
<p>Processing Validity Time To Date Time /Document/RtrTx/RptOrErr/BizRpt/TxRpt/TxOrErr/Tx/Pmt/PrcgVldtyTm/ToDtTm</p>	<p>Provides the respective timestamp for latest execution time (Reject Time).</p>
<p>Processing Validity Time Date Time Range From Date Time /Document/RtrTx/RptOrErr/BizRpt/TxRpt/TxOrErr/Tx/Pmt/PrcgVldtyTm/DtTmRg/FrDtTm</p>	<p>Provides the respective timestamp for earliest execution time (From Time).</p>
<p>Processing Validity Time Date Time Range To Date Time /Document/RtrTx/RptOrErr/BizRpt/TxRpt/TxOrErr/Tx/Pmt/PrcgVldtyTm/DtTmRg/ToDtTm</p>	<p>Provides the respective timestamp for latest execution time (Reject Time).</p>
<p>Instruction Copy /Document/RtrTx/RptOrErr/BizRpt/TxRpt/TxOrErr/Tx/Pmt/InstrCpy</p>	<p>Provides the message string of a cash transfer (order) entered via A2A (pacs.009/010 and camt.050) and U2A (pacs.009) consisting of BAH + Document. The message string is provided in CDATA format.</p>
<p>Type Proprietary /Document/RtrTx/RptOrErr/BizRpt/TxRpt/TxOrErr/Tx/Pmt/Tp/Prtry</p>	<p>Please find the code list in UDFS section Cash Transfer Category and Business Case Codes for various features [172].</p>
<p>Inter Bank Settlement Date /Document/RtrTx/RptOrErr/BizRpt/TxRpt/TxOrErr/Tx/Pmt/InstrBkSttlmDt</p>	<p>Date of CLM business day for the settlement of the cash transfer (order).</p>
<p>End To End Identification /Document/RtrTx/RptOrErr/BizRpt/TxRpt/TxOrErr/Tx/Pmt/EndToEndId</p>	<p>End To End Identification of the cash transfer (order).</p> <ul style="list-style-type: none"> In case of direct debit generated by Billing component this is the Invoice Number. Standing Order Identification of the underlying standing order liquidity transfer defined by the CLM Account

Message item	Utilisation
	<p>Holder in CRDM.</p> <ul style="list-style-type: none"> Floor/Ceiling Order Identification of the underlying floor/ceiling liquidity transfer defined by the CLM Account Holder in CRDM. Business case ID in case of other system-generated cash transfer (order)s.
Business Report – Transaction Report – Transaction – Payment – Parties	
Instructing Agent BIC /Document/RtrTx/RptOrErr/BizRpt/TxRpt/TxOrErr/Tx/Pmt/P ties/InstgAgt/FinInstnId/BICFI	Provides BIC of <InstructingAgent> in the case of payment (order).
Instructed Agent BIC /Document/RtrTx/RptOrErr/BizRpt/TxRpt/TxOrErr/Tx/Pmt/P ties/InstdAgt/FinInstnId/BICFI	Provides BIC of <InstructedAgent> in the case of payment (order).
Business Report – Transaction Report – Transaction – Payment – Parties – Debtor	
Provides the:	
<ul style="list-style-type: none"> BIC of <Debtor> if used in the cash transfer (order) Account number from <DebtorAccount> in the case of liquidity transfer (order). 	
Debtor BIC /Document/RtrTx/RptOrErr/BizRpt/TxRpt/TxOrErr/Tx/Pmt/P ties/Dbtr/Pty/Id/OrgId/AnyBIC	Provides the BIC of <Debtor> if used in the cash transfer (order).
Debtor Agent LEI /Document/RtrTx/RptOrErr/BizRpt/TxRpt/TxOrErr/Tx/PmtFr /Mmbld/FinInstnId/LEI	Not provided by CLM
Debtor Identification /Document/RtrTx/RptOrErr/BizRpt/TxRpt/TxOrErr/Tx/Pmt/P ties/Dbtr/Pty/Id/OrgId/Othr/Id	Provides the account number from <DebtorAccount> in the case of liquidity transfer (order).
Business Report – Transaction Report – Transaction – Payment – Parties – Creditor	
Provides the:	
<ul style="list-style-type: none"> BIC of <Creditor> if used in the cash transfer (order) Account number from <CreditorAccount> in the case of liquidity transfer (order). 	
Creditor BIC Document/RtrTx/RptOrErr/BizRpt/TxRpt/TxOrErr/Tx/Pmt/Pti	Provides the BIC of <Creditor> if used in the cash transfer (order).

Message item	Utilisation
es/Cdtr/Pty/Id/OrgId/AnyBIC	
Creditor Agent LEI Document/RtrTx/RptOrErr/BizRpt/TxRpt/TxOrErr/Tx/Pmt/Pties/Cdtr/Pty/Id/OrgId/LEI	Not provided by CLM
Creditor Identification /Document/RtrTx/RptOrErr/BizRpt/TxRpt/TxOrErr/Tx/Pmt/Pties/Cdtr/Pty/Id/OrgId/Othr/Id	Provides the account number from <CreditorAccount> in the case of liquidity transfer (order).
Business Report – Transaction Report – Transaction – Account Entry	
Account Identification /Document/RtrTx/RptOrErr/BizRpt/TxRpt/TxOrErr/Tx/AcctNtry/Acct/Id/Othr/Id	Debtor or creditor CLM cash account number of the cash transfer (order).
Account Owner Name /Document/RtrTx/RptOrErr/BizRpt/TxRpt/TxOrErr/Tx/AcctNtry/Acct/Ownr/Nm	Name by which a party is known and which is usually used to identify that party.
Account Owner BIC /Document/RtrTx/RptOrErr/BizRpt/TxRpt/TxOrErr/Tx/AcctNtry/Acct/Ownr/Id/OrgId/AnyBIC	Party BIC of owner of debtor or creditor cash account of the cash transfer (order).
Account Owner LEI /Document/RtrTx/RptOrErr/BizRpt/TxRpt/TxOrErr/Tx/AcctNtry/Acct/Ownr/Id/OrgId/LEI	Not provided by CLM
Business Report – Transaction Report – Transaction – Account Entry - Entry	
Provides <Amount> and <DateTime> information regarding a posting on the reported CLM cash account. <Entry> is not provided if the related cash transfer order is not (yet) posted on the account.	
Entry Amount /Document/RtrTx/RptOrErr/BizRpt/TxRpt/TxOrErr/Tx/AcctNtry/Ntry/Amt	Provides the posted amount and currency of the cash transfer on the reported CLM cash account. Posted <Amount> can deviate from instructed settlement amount of the related cash transfer in <IntrBkSttImAmt> in case of partial execution.
Entry Date Time /Document/RtrTx/RptOrErr/BizRpt/TxRpt/TxOrErr/Tx/AcctNtry/Ntry/Dt/DtTm	Time stamp including the calendar date of the settlement of the cash transfer on the CLM cash account.

Message item	Utilisation
Operational Error	
Message block <OprlErr> is provided in case of invalid <GetTransaction> query. Please find further detailed information within UDFS Appendix " Index of validation rules and error codes [643]"	
Error Proprietary /Document/RtrTx/RptOrErr/OprlErr/Err/Prtry	Provides the error code.
Description /Document/RtrTx/RptOrErr/OprlErr/Desc	Provides the detailed error description.

Table 136 - ReturnTransaction (camt.006)

Usage case: Delta set reporting query (Initialise) camt.006 (Scenario 077)

In this example, CLM is responding to the business sender with the transaction information resulting from a valid camt.005 query for all transactions on MCA (Id: MDEEURLADESTXXXXSOLADESTXXX) which were entered before 09:00:00 on the business day of "2021-08-25". CLM has also initialised a delta set with this search criteria and result set, with a name of "CLMDELTA-b077".

In this case, there are 2 payment orders queued, awaiting settlement.

Message item	Utilisation
Message Identification /Document/RtrTx/MsgHdr/Msgld	NONREF
Original Business Query /Document/RtrTx/MsgHdr/OrgnlBizQry/Msgld	Inc005b077In-BAH
Request Type /Document/RtrTx/MsgHdr/ReqTp/Prtry/ld	INIT
Query Name /Document/RtrTx/MsgHdr/QryNm	CLMDELTA-b077
Transaction Report	
Payment Identification /Document/RtrTx/RptOrErr/BizRpt/TxRpt/Pmtld/Prtryld	CLM-p009b077B
Credit Debit Indicator /Document/RtrTx/RptOrErr/BizRpt/TxRpt/TxOrErr/Tx/CdtDbtInd	CRDT
Status Code Pending /Document/RtrTx/RptOrErr/BizRpt/TxRpt/TxOrErr/Tx/Pmt/Sts/Cd/Pdg	PSTL

Message item	Utilisation
Interbank Settlement Amount /Document/RtrTx/RptOrErr/BizRpt/TxRpt/TxOrErr/Tx/Pmt/IntrBkSttlmAmt/AmtWthCcy	EUR 2000.00
End To End Identification /Document/RtrTx/RptOrErr/BizRpt/TxRpt/TxOrErr/Tx/Pmt/EndToEndId	Inp009b077B-E2EId
Account Identification /Document/RtrTx/RptOrErr/BizRpt/TxRpt/TxOrErr/Tx/AccountNtry/Acct/Id/Othr/Id	MDEEURSOLADESTXXXSOLADESTXXX
Account Owner Name /Document/RtrTx/RptOrErr/BizRpt/TxRpt/TxOrErr/Tx/AccountNtry/Acct/Ownr/Nm	Landesbank Baden-Wuerttemberg, Stuttgart
Account Owner BIC /Document/RtrTx/RptOrErr/BizRpt/TxRpt/TxOrErr/Tx/AccountNtry/Acct/Ownr/Id/Orgld/AnyBIC	SOLADESTXXX
Transaction Report	
Payment Identification /Document/RtrTx/RptOrErr/BizRpt/TxRpt/PmtId/PrtryId	CLM-p009b077D
Credit Debit Indicator /Document/RtrTx/RptOrErr/BizRpt/TxRpt/TxOrErr/Tx/CdtDbtInd	DBIT
Status Code Pending /Document/RtrTx/RptOrErr/BizRpt/TxRpt/TxOrErr/Tx/Pmt/Sts/Cd/Pdg	PSTL
Interbank Settlement Amount /Document/RtrTx/RptOrErr/BizRpt/TxRpt/TxOrErr/Tx/Pmt/IntrBkSttlmAmt/AmtWthCcy	EUR 4000.00
End To End Identification /Document/RtrTx/RptOrErr/BizRpt/TxRpt/TxOrErr/Tx/Pmt/EndToEndId	Inp009b077D-E2EId

Message item	Utilisation
Account Identification /Document/RtrTx/RptOrErr/BizRpt/TxRpt/TxOrErr/Tx/ActNtry/Acct/Id/Othr/Id	MDEEURSOLADESTXXXSOLADESTXXX
Account Owner Name /Document/RtrTx/RptOrErr/BizRpt/TxRpt/TxOrErr/Tx/ActNtry/Acct/Ownr/Nm	Landesbank Baden-Wuerttemberg, Stuttgart
Account Owner BIC /Document/RtrTx/RptOrErr/BizRpt/TxRpt/TxOrErr/Tx/ActNtry/Acct/Ownr/Id/Orgld/AnyBIC	SOLADESTXXX

Table 137 - ReturnTransaction (camt.006) – usage case delta set query - initialisation (Scenario 077)

Usage case example: camt.006_CLM_ReturnTransaction_INIT_bs077.xml

Usage case: Delta set reporting query (first delta query) camt.006 (Scenario 077)

In this example, CLM is responding to the business sender with the transaction information resulting from a valid camt.005 delta request based upon delta set with the name “CLMDELTA-b077”.

For the purposes of this scenario, this message will show delta payment order activity on MCA (Id: MDEEURSOLADESTXXXSOLADESTXXX) between 09:00 and 10:00 on the business day of “2021-08-25”.

In this case, there are 2 payment orders queued, awaiting settlement.

Message item	Utilisation
Message Identification /Document/RtrTx/MsgHdr/MsgId	NONREF
Original Business Query /Document/RtrTx/MsgHdr/OrgnlBizQry/MsgId	Inc005b077D1-BAH
Query Name /Document/RtrTx/MsgHdr/QryNm	CLMDELTA-b077
Transaction Report	
Payment Identification /Document/RtrTx/RptOrErr/BizRpt/TxRpt/PmtId/PrtryId	CLM-p009b077A
Credit Debit Indicator /Document/RtrTx/RptOrErr/BizRpt/TxRpt/TxOrErr/Tx/CdtDbtInd	CRDT
Status Code Pending /Document/RtrTx/RptOrErr/BizRpt/TxRpt/TxOrErr/Tx/P	PSTL

Message item	Utilisation
mt/Sts/Cd/Pdg	
Interbank Settlement Amount /Document/RtrTx/RptOrErr/BizRpt/TxRpt/TxOrErr/Tx/P mt/IntrBkStlmAmt/AmtWthCcy	EUR 1000.00
End To End Identification /Document/RtrTx/RptOrErr/BizRpt/TxRpt/TxOrErr/Tx/P mt/EndToEndId	Inp009b077A-E2EId
Account Identification /Document/RtrTx/RptOrErr/BizRpt/TxRpt/TxOrErr/Tx/Ac ctNtry/Acct/Id/Othr/Id	MDEEURSOLADESTXXXSOLADESTXXX
Account Owner Name /Document/RtrTx/RptOrErr/BizRpt/TxRpt/TxOrErr/Tx/Ac ctNtry/Acct/Ownr/Nm	Landesbank Baden-Wuerttemberg, Stuttgart
Account Owner BIC /Document/RtrTx/RptOrErr/BizRpt/TxRpt/TxOrErr/Tx/Ac ctNtry/Acct/Ownr/Id/OrgId/AnyBIC	SOLADESTXXX
Transaction Report	
Payment Identification /Document/RtrTx/RptOrErr/BizRpt/TxRpt/PmtId/PrtryId	CLM-p009b077C
Credit Debit Indicator /Document/RtrTx/RptOrErr/BizRpt/TxRpt/TxOrErr/Tx/Cd tDbtInd	DBIT
Status Code Pending /Document/RtrTx/RptOrErr/BizRpt/TxRpt/TxOrErr/Tx/P mt/Sts/Cd/Pdg	PSTL
Interbank Settlement Amount /Document/RtrTx/RptOrErr/BizRpt/TxRpt/TxOrErr/Tx/P mt/IntrBkStlmAmt/AmtWthCcy	EUR 3000.00
End To End Identification /Document/RtrTx/RptOrErr/BizRpt/TxRpt/TxOrErr/Tx/P mt/EndToEndId	Inp009b077C-E2EId

Message item	Utilisation
Account Identification /Document/RtrTx/RptOrErr/BizRpt/TxRpt/TxOrErr/Tx/ActNtry/ActId/Othr/Id	MDEEURSOLADESTXXXSOLADESTXXX
Account Owner Name /Document/RtrTx/RptOrErr/BizRpt/TxRpt/TxOrErr/Tx/ActNtry/Act/Ownr/Nm	Landesbank Baden-Wuerttemberg, Stuttgart
Account Owner BIC /Document/RtrTx/RptOrErr/BizRpt/TxRpt/TxOrErr/Tx/ActNtry/Act/Ownr/Id/Orgld/AnyBIC	SOLADESTXXX

Table 138 - ReturnTransaction (camt.006) – usage case delta set query – first delta query (Scenario 077)

Usage case example: camt.006_CLM_ReturnTransaction_DLT1_bs077.xml

Usage case: Delta set reporting query (second delta query) camt.006 (Scenario 077)

In this example, CLM is responding to the business sender with the transaction information resulting from a valid camt.005 delta request based upon delta set with the name “CLMDELTA-b077”.

For the purposes of this scenario, this message will show delta payment order activity on MCA (Id: MDEEURSOLADESTXXXSOLADESTXXX) between 10:00 and 11:00 on the business day of “2021-08-25”.

In this case, there are 2 payment orders: one has settled; the other has been revoked.

Message item	Utilisation
Message Identification /Document/RtrTx/MsgHdr/MsgId	NONREF
Original Business Query /Document/RtrTx/MsgHdr/OrgnlBizQry/MsgId	Inc005b077D2-BAH
Query Name /Document/RtrTx/MsgHdr/QryNm	CLMDELTA-b077
Transaction Report	
Payment Identification /Document/RtrTx/RptOrErr/BizRpt/TxRpt/PmtId/PrtryId	CLM-p009b077B
Credit Debit Indicator /Document/RtrTx/RptOrErr/BizRpt/TxRpt/TxOrErr/Tx/CdtDbtInd	CRDT
Status Code Pending /Document/RtrTx/RptOrErr/BizRpt/TxRpt/TxOrErr/Tx/P	STLD

Message item	Utilisation
mt/Sts/Cd/Pdg	
Interbank Settlement Amount /Document/RtrTx/RptOrErr/BizRpt/TxRpt/TxOrErr/Tx/P mt/IntrBkStlmAmt/AmtWthCcy	EUR 2000.00
End To End Identification /Document/RtrTx/RptOrErr/BizRpt/TxRpt/TxOrErr/Tx/P mt/EndToEndId	Inp009b077B-E2EId
Account Identification /Document/RtrTx/RptOrErr/BizRpt/TxRpt/TxOrErr/Tx/Ac ctNtry/Acct/Id/Othr/Id	MDEEURSOLADESTXXXSOLADESTXXX
Account Owner Name /Document/RtrTx/RptOrErr/BizRpt/TxRpt/TxOrErr/Tx/Ac ctNtry/Acct/Ownr/Nm	Landesbank Baden-Wuerttemberg, Stuttgart
Account Owner BIC /Document/RtrTx/RptOrErr/BizRpt/TxRpt/TxOrErr/Tx/Ac ctNtry/Acct/Ownr/Id/OrgId/AnyBIC	SOLADESTXXX
Transaction Report	
Payment Identification /Document/RtrTx/RptOrErr/BizRpt/TxRpt/PmtId/PrtryId	CLM-p009b077C
Credit Debit Indicator /Document/RtrTx/RptOrErr/BizRpt/TxRpt/TxOrErr/Tx/Cd tDbtInd	DBIT
Status Code Pending /Document/RtrTx/RptOrErr/BizRpt/TxRpt/TxOrErr/Tx/P mt/Sts/Cd/Pdg	CAND
Interbank Settlement Amount /Document/RtrTx/RptOrErr/BizRpt/TxRpt/TxOrErr/Tx/P mt/IntrBkStlmAmt/AmtWthCcy	EUR 3000.00
End To End Identification /Document/RtrTx/RptOrErr/BizRpt/TxRpt/TxOrErr/Tx/P mt/EndToEndId	Inp009b077C-E2EId

Message item	Utilisation
Account Identification /Document/RtrTx/RptOrErr/BizRpt/TxRpt/TxOrErr/Tx/ActNtry/Acct/Id/Othr/Id	MDEEURSOLADESTXXXSOLADESTXXX
Account Owner Name /Document/RtrTx/RptOrErr/BizRpt/TxRpt/TxOrErr/Tx/ActNtry/Acct/Ownr/Nm	Landesbank Baden-Wuerttemberg, Stuttgart
Account Owner BIC /Document/RtrTx/RptOrErr/BizRpt/TxRpt/TxOrErr/Tx/ActNtry/Acct/Ownr/Id/Orgld/AnyBIC	SOLADESTXXX

Table 139 - ReturnTransaction (camt.006) – usage case delta set query – second delta query (Scenario 077)

Usage case example: camt.006_CLM_ReturnTransaction_DLT2_bs077.xml

Usage case: Delta set reporting query (third delta query) camt.006 (Scenario 077)

In this example, CLM is responding to the business sender with the transaction information resulting from a valid camt.005 delta request based upon delta set with the name “CLMDELTA-b077”.

For the purposes of this scenario, this message will show delta payment order activity on MCA (Id: MDEEURSOLADESTXXXSOLADESTXXX) between 11:00 and 12:00 on the business day of “2021-08-25”.

In this case, there are 2 payment orders: one has settled; the other has been rejected.

Message item	Utilisation
Message Identification /Document/RtrTx/MsgHdr/MsgId	NONREF
Original Business Query /Document/RtrTx/MsgHdr/OrgnlBizQry/MsgId	Inc005b077D3-BAH
Query Name /Document/RtrTx/MsgHdr/QryNm	CLMDELTA-b077
Transaction Report	
Payment Identification /Document/RtrTx/RptOrErr/BizRpt/TxRpt/PmtId/PrtryId	CLM-p009b077A
Credit Debit Indicator /Document/RtrTx/RptOrErr/BizRpt/TxRpt/TxOrErr/Tx/CdtDbtInd	CRDT
Status Code Pending /Document/RtrTx/RptOrErr/BizRpt/TxRpt/TxOrErr/Tx/P	STLD

Message item	Utilisation
mt/Sts/Cd/Pdg	
Interbank Settlement Amount /Document/RtrTx/RptOrErr/BizRpt/TxRpt/TxOrErr/Tx/P mt/IntrBkStlmAmt/AmtWthCcy	EUR 1000.00
End To End Identification /Document/RtrTx/RptOrErr/BizRpt/TxRpt/TxOrErr/Tx/P mt/EndToEndId	Inp009b077A-E2EId
Account Identification /Document/RtrTx/RptOrErr/BizRpt/TxRpt/TxOrErr/Tx/Ac ctNtry/Acct/Id/Othr/Id	MDEEURSOLADESTXXXSOLADESTXXX
Account Owner Name /Document/RtrTx/RptOrErr/BizRpt/TxRpt/TxOrErr/Tx/Ac ctNtry/Acct/Ownr/Nm	Landesbank Baden-Wuerttemberg, Stuttgart
Account Owner BIC /Document/RtrTx/RptOrErr/BizRpt/TxRpt/TxOrErr/Tx/Ac ctNtry/Acct/Ownr/Id/OrgId/AnyBIC	SOLADESTXXX
Transaction Report	
Payment Identification /Document/RtrTx/RptOrErr/BizRpt/TxRpt/PmtId/PrtryId	CLM-p009b077D
Credit Debit Indicator /Document/RtrTx/RptOrErr/BizRpt/TxRpt/TxOrErr/Tx/Cd tDbtInd	DBIT
Status Code Pending /Document/RtrTx/RptOrErr/BizRpt/TxRpt/TxOrErr/Tx/P mt/Sts/Cd/Pdg	RJTD
Interbank Settlement Amount /Document/RtrTx/RptOrErr/BizRpt/TxRpt/TxOrErr/Tx/P mt/IntrBkStlmAmt/AmtWthCcy	EUR 4000.00
End To End Identification /Document/RtrTx/RptOrErr/BizRpt/TxRpt/TxOrErr/Tx/P mt/EndToEndId	Inp009b077D-E2EId

Message item	Utilisation
Account Identification /Document/RtrTx/RptOrErr/BizRpt/TxRpt/TxOrErr/Tx/AccountNtry/Acct/Id/Othr/Id	MDEEURSOLADESTXXXSOLADESTXXX
Account Owner Name /Document/RtrTx/RptOrErr/BizRpt/TxRpt/TxOrErr/Tx/AccountNtry/Acct/Ownr/Nm	Landesbank Baden-Wuerttemberg, Stuttgart
Account Owner BIC /Document/RtrTx/RptOrErr/BizRpt/TxRpt/TxOrErr/Tx/AccountNtry/Acct/Ownr/Id/OrgId/AnyBIC	SOLADESTXXX

Table 140 - ReturnTransaction (camt.006) – usage case delta set query – third delta query (Scenario 077)

Usage case example: camt.006_CLM_ReturnTransaction_DLT3_bs077.xml

Usage case: CLM Return Transaction camt.006 (Scenario 102)

In this example, CLM is showing all transactions fulfilling the query criteria in the provided query message. The accounts involved are only those within the sender’s data scope. The transactions listed arise from activity within bs050 (camt.050) and bs073.

Message item	Utilisation
Message Header	
Message Identification /Document/RtrTx/MsgHdr/MsgId	NONREF
Original Business Query /Document/RtrTx/MsgHdr/OrgnlBizQry/MsgId	Inc005b102-BAHId
Business Report – Transaction Report	
Payment Identification /Document/RtrTx/RptOrErr/BizRpt/TxRpt/PmtId/PrtryId	CLM-AMLRb073
Credit Debit Indicator /Document/RtrTx/RptOrErr/BizRpt/TxRpt/TxOrErr/Tx/CdtDbtInd	DBIT
Business Report – Transaction Report – Transaction – Payment	
Status Code Final /Document/RtrTx/RptOrErr/BizRpt/TxRpt/TxOrErr/Tx/Pmts/Cd/Fnl	STLD

Message item	Utilisation
Interbank Settlement Amount /Document/RtrTx/RptOrErr/BizRpt/TxRpt/TxOrErr/Tx/Pmt/IntrBkSttlmAmt/AmtWthCcy	EUR 117000.00
Type Proprietary /Document/RtrTx/RptOrErr/BizRpt/TxRpt/TxOrErr/Tx/Pmt/Tp/Prtry	AMLR
End To End Identification /Document/RtrTx/RptOrErr/BizRpt/TxRpt/TxOrErr/Tx/Pmt/EndToEndId	SDAMLRb073-E2EId
Business Report – Transaction Report – Transaction – Account Entry	
Account Identification /Document/RtrTx/RptOrErr/BizRpt/TxRpt/TxOrErr/Tx/AcctNtry/Acct/Id/Othr/Id	MDEEURCOBADEFFXXXCOBADEFFXXX
Account Owner Name /Document/RtrTx/RptOrErr/BizRpt/TxRpt/TxOrErr/Tx/AcctNtry/Acct/Ownr/Nm	Commerzbank, Frankfurt
Account Owner BIC /Document/RtrTx/RptOrErr/BizRpt/TxRpt/TxOrErr/Tx/AcctNtry/Acct/Ownr/Id/OrgId/AnyBIC	COBADEFFXXX
Entry Amount /Document/RtrTx/RptOrErr/BizRpt/TxRpt/TxOrErr/Tx/AcctNtry/Ntry/Amt	EUR 117000.00
Entry Date Time /Document/RtrTx/RptOrErr/BizRpt/TxRpt/TxOrErr/Tx/AcctNtry/Ntry/Dt/DtTm	2019-10-07T19:15:01.000+00:00
Business Report – Transaction Report	
Payment Identification /Document/RtrTx/RptOrErr/BizRpt/TxRpt/PmtId/PrtryId	CLM-c050b050
Credit Debit Indicator /Document/RtrTx/RptOrErr/BizRpt/TxRpt/TxOrErr/Tx/CdtDbtInd	DBIT
Business Report – Transaction Report – Transaction – Payment	

Message item	Utilisation
Status Code Final /Document/RtrTx/RptOrErr/BizRpt/TxRpt/TxOrErr/Tx/Pmt/S ts/Cd/Fnl	STLD
Interbank Settlement Amount /Document/RtrTx/RptOrErr/BizRpt/TxRpt/TxOrErr/Tx/Pmt/In trBkSttlmAmt/AmtWthCcy	EUR 100000.00
Type Proprietary /Document/RtrTx/RptOrErr/BizRpt/TxRpt/TxOrErr/Tx/Pmt/T p/Prtry	LIIA
End To End Identification /Document/RtrTx/RptOrErr/BizRpt/TxRpt/TxOrErr/Tx/Pmt/E ndToEndId	Inc050b050-E2EId
Business Report – Transaction Report – Transaction – Account Entry	
Account Identification /Document/RtrTx/RptOrErr/BizRpt/TxRpt/TxOrErr/Tx/AcctNt ry/Acct/Id/Othr/Id	MDEEURCOBADEFFXXXCOBADEFFXXX
Account Owner Name /Document/RtrTx/RptOrErr/BizRpt/TxRpt/TxOrErr/Tx/AcctNt ry/Acct/Ownr/Nm	Commerzbank, Frankfurt
Account Owner BIC /Document/RtrTx/RptOrErr/BizRpt/TxRpt/TxOrErr/Tx/AcctNt ry/Acct/Ownr/Id/OrgId/AnyBIC	COBADEFFXXX
Entry Amount /Document/RtrTx/RptOrErr/BizRpt/TxRpt/TxOrErr/Tx/AcctNt ry/Ntry/Amt	EUR 100000.00
Entry Date Time /Document/RtrTx/RptOrErr/BizRpt/TxRpt/TxOrErr/Tx/AcctNt ry/Ntry/Dt/DtTm	2019-10-08T14:19:00.001+00:00

Table 141 - ReturnTransaction (camt.006) – usage case Account holder requesting all transactions (Scenario 102)

Usage case example: camt.006_CLM_ReturnTransaction_bs102.xml

Usage case: CLM Get Transaction camt.006 (Scenario 103)

In this example, CLM is responding to the business sender of an invalid inbound camt.005 message, with information relating to the validation errors found.

In this case, the business rule code is “E112” with a description of “Invalid search criteria”.

Message item	Utilisation
Message Header	
Message Identification /Document/RtrTx/MsgHdr/MsgId	NONREF
Original Business Query /Document/RtrTx/MsgHdr/OrgnBizQry/MsgId	Inc005b103-BAHId
Operational Error	
Error Proprietary /Document/RtrTx/RptOrErr/OprlErr/Err/Prtry	E112
Description /Document/RtrTx/RptOrErr/OprlErr/Desc	Invalid search criteria

Table 142 - ReturnTransaction (camt.006) – usage case request for transactions with error response (Scenario 103)

Usage case example: camt.006_CLM_ReturnTransaction_bs103.xml

Usage case: CLM Return Transaction camt.006 (Scenario 106)

In this example, CLM is showing the 4 pieces of data requested in the query message, which relate to the transaction that was also explicitly identified in the query. The transaction itself was created in bs004 (pacs.009).

Message item	Utilisation
Message Header	
Message Identification /Document/RtrTx/MsgHdr/MsgId	NONREF
Original Business Query /Document/RtrTx/MsgHdr/OrgnBizQry/MsgId	Inc005b106-BAHId
Business Report – Transaction Report	
Payment Identification /Document/RtrTx/RptOrErr/BizRpt/TxRpt/PmtId/PrtryId	CLM-p009b004

Message item	Utilisation
Credit Debit Indicator /Document/RtrTx/RptOrErr/BizRpt/TxRpt/TxOrErr/Tx/CdtDb tInd	CRDT
Business Report – Transaction Report – Transaction – Payment	
Status Code Final /Document/RtrTx/RptOrErr/BizRpt/TxRpt/TxOrErr/Tx/Pmt/S ts/Cd/Fnl	STLD
Interbank Settlement Amount /Document/RtrTx/RptOrErr/BizRpt/TxRpt/TxOrErr/Tx/Pmt/In trBkSttlmAmt/AmtWthCcy	EUR 285000.00
Type Proprietary /Document/RtrTx/RptOrErr/BizRpt/TxRpt/TxOrErr/Tx/Pmt/T p/Prtry	OCBO
End To End Identification /Document/RtrTx/RptOrErr/BizRpt/TxRpt/TxOrErr/Tx/Pmt/E ndToEndId	Inp009b004-E2EId
Business Report – Transaction Report – Transaction – Account Entry	
Account Identification /Document/RtrTx/RptOrErr/BizRpt/TxRpt/TxOrErr/Tx/AcctNt ry/Acct/Id/Othr/Id	MDEEURSOLADESTXXXSOLADESTXXX
Account Owner Name /Document/RtrTx/RptOrErr/BizRpt/TxRpt/TxOrErr/Tx/AcctNt ry/Acct/Ownr/Nm	Landesbank Baden-Wuerttemberg, Stuttgart
Account Owner BIC /Document/RtrTx/RptOrErr/BizRpt/TxRpt/TxOrErr/Tx/AcctNt ry/Acct/Ownr/Id/OrgId/AnyBIC	SOLADESTXXX

Table 143 - ReturnTransaction (camt.006) – usage case Account holder requesting a single transaction (Scenario 106)

Usage case example: camt.006_CLM_ReturnTransaction_bs106.xml

Usage case: CLM Return Transaction camt.006 (Scenario 107)

In this example, CLM is showing all transactions fulfilling the query criteria in the provided query message. The accounts involved are all those within the sending CB's data scope. The transactions listed arise from activity within bs002 (pacs.009 CONP), bs004 (pacs.009), bs050 (camt.050) and bs073.

Message item	Utilisation
Message Header	
Message Identification /Document/RtrTx/MsgHdr/MsgId	NONREF
Original Business Query /Document/RtrTx/MsgHdr/OrgnlBizQry/MsgId	Inc005b107-BAHId
Business Report – Transaction Report	
Payment Identification /Document/RtrTx/RptOrErr/BizRpt/TxRpt/PmtId/PrtryId	CLM-AMLRb073
Credit Debit Indicator /Document/RtrTx/RptOrErr/BizRpt/TxRpt/TxOrErr/Tx/CdtDbtInd	DBIT
Business Report – Transaction Report – Transaction – Payment	
Status Code Final /Document/RtrTx/RptOrErr/BizRpt/TxRpt/TxOrErr/Tx/Pmt/Status/Cd/Fnl	STLD
Interbank Settlement Amount /Document/RtrTx/RptOrErr/BizRpt/TxRpt/TxOrErr/Tx/Pmt/InterBkSttlmAmt/AmtWthCcy	EUR 117000.00
Type Proprietary /Document/RtrTx/RptOrErr/BizRpt/TxRpt/TxOrErr/Tx/Pmt/Type/Prtry	AMLR
End To End Identification /Document/RtrTx/RptOrErr/BizRpt/TxRpt/TxOrErr/Tx/Pmt/EndToEndId	SDAMLRb073-E2EId
Business Report – Transaction Report – Transaction – Account Entry	
Account Identification /Document/RtrTx/RptOrErr/BizRpt/TxRpt/TxOrErr/Tx/AccountEntry/AcctId/OthrId	MDEEURCOBADEFFXXXXCOBADEFFXXX

Message item	Utilisation
Account Owner Name /Document/RtrTx/RptOrErr/BizRpt/TxRpt/TxOrErr/Tx/AcctNtry/Acct/Ownr/Nm	Commerzbank, Frankfurt
Account Owner BIC /Document/RtrTx/RptOrErr/BizRpt/TxRpt/TxOrErr/Tx/AcctNtry/Acct/Ownr/ld/Orgld/AnyBIC	COBADEFFXXX
Entry Amount /Document/RtrTx/RptOrErr/BizRpt/TxRpt/TxOrErr/Tx/AcctNtry/Ntry/Amt	EUR 117000.00
Entry Date Time /Document/RtrTx/RptOrErr/BizRpt/TxRpt/TxOrErr/Tx/AcctNtry/Ntry/Dt/DtTm	2019-10-07T19:15:01.000+00:00
Business Report – Transaction Report	
Payment Identification /Document/RtrTx/RptOrErr/BizRpt/TxRpt/Pmtld/Prtryld	CLM-p009b002
Credit Debit Indicator /Document/RtrTx/RptOrErr/BizRpt/TxRpt/TxOrErr/Tx/CdtDbtlnd	CRDT
Business Report – Transaction Report – Transaction – Payment	
Status Code Final /Document/RtrTx/RptOrErr/BizRpt/TxRpt/TxOrErr/Tx/Pmt/Ssts/Cd/Fnl	STLD
Interbank Settlement Amount /Document/RtrTx/RptOrErr/BizRpt/TxRpt/TxOrErr/Tx/Pmt/IntrBkSttlmAmt/AmtWthCcy	EUR 0.00
Type Proprietary /Document/RtrTx/RptOrErr/BizRpt/TxRpt/TxOrErr/Tx/Pmt/Tp/Prtry	CONP
End To End Identification /Document/RtrTx/RptOrErr/BizRpt/TxRpt/TxOrErr/Tx/Pmt/EndToEndld	Inp009b002-E2Eld
Business Report – Transaction Report – Transaction – Account Entry	

Message item	Utilisation
Account Identification /Document/RtrTx/RptOrErr/BizRpt/TxRpt/TxOrErr/Tx/AcctNtry/Acct/Id/Othr/Id	MDEEURSOLADESTXXXSOLADESTXXX
Account Owner Name /Document/RtrTx/RptOrErr/BizRpt/TxRpt/TxOrErr/Tx/AcctNtry/Acct/Ownr/Nm	Landesbank Baden-Wuerttemberg, Stuttgart
Account Owner BIC /Document/RtrTx/RptOrErr/BizRpt/TxRpt/TxOrErr/Tx/AcctNtry/Acct/Ownr/Id/OrgId/AnyBIC	SOLADESTXXX
Entry Amount /Document/RtrTx/RptOrErr/BizRpt/TxRpt/TxOrErr/Tx/AcctNtry/Ntry/Amt	EUR 0.00
Entry Date Time /Document/RtrTx/RptOrErr/BizRpt/TxRpt/TxOrErr/Tx/AcctNtry/Ntry/Dt/DtTm	2019-10-08T09:42:25.001+00:00
Business Report – Transaction Report	
Payment Identification /Document/RtrTx/RptOrErr/BizRpt/TxRpt/PmtId/PrtryId	CLM-c050b050
Credit Debit Indicator /Document/RtrTx/RptOrErr/BizRpt/TxRpt/TxOrErr/Tx/CdtDbtInd	DBIT
Business Report – Transaction Report – Transaction – Payment	
Status Code Final /Document/RtrTx/RptOrErr/BizRpt/TxRpt/TxOrErr/Tx/Pmt/Sts/Cd/Fnl	STLD
Interbank Settlement Amount /Document/RtrTx/RptOrErr/BizRpt/TxRpt/TxOrErr/Tx/Pmt/IntrBkSttlmAmt/AmtWthCcy	EUR 100000.00
Type Proprietary /Document/RtrTx/RptOrErr/BizRpt/TxRpt/TxOrErr/Tx/Pmt/Typ/Prtry	LIIA
End To End Identification	Inc050b050-E2EId

Message item	Utilisation
/Document/RtrTx/RptOrErr/BizRpt/TxRpt/TxOrErr/Tx/Pmt/EndToEndId	
Business Report – Transaction Report – Transaction – Account Entry	
Account Identification /Document/RtrTx/RptOrErr/BizRpt/TxRpt/TxOrErr/Tx/AcctNtry/Acct/Id/Othr/Id	MDEEURCOBADEFFXXXXCOBADEFFXXX
Account Owner Name /Document/RtrTx/RptOrErr/BizRpt/TxRpt/TxOrErr/Tx/AcctNtry/Acct/Ownr/Nm	Commerzbank, Frankfurt
Account Owner BIC /Document/RtrTx/RptOrErr/BizRpt/TxRpt/TxOrErr/Tx/AcctNtry/Acct/Ownr/Id/OrgId/AnyBIC	COBADEFFXXX
Entry Amount /Document/RtrTx/RptOrErr/BizRpt/TxRpt/TxOrErr/Tx/AcctNtry/Ntry/Amt	EUR 100000.00
Entry Date Time /Document/RtrTx/RptOrErr/BizRpt/TxRpt/TxOrErr/Tx/AcctNtry/Ntry/Dt/DtTm	2019-10-08T14:19:00.001+00:00
Business Report – Transaction Report	
Payment Identification /Document/RtrTx/RptOrErr/BizRpt/TxRpt/PmtId/PrtryId	CLM-c050b050
Credit Debit Indicator /Document/RtrTx/RptOrErr/BizRpt/TxRpt/TxOrErr/Tx/CdtDbtInd	CRDT
Business Report – Transaction Report – Transaction – Payment	
Status Code Final /Document/RtrTx/RptOrErr/BizRpt/TxRpt/TxOrErr/Tx/Pmt/Stats/Cd/Fnl	STLD
Interbank Settlement Amount /Document/RtrTx/RptOrErr/BizRpt/TxRpt/TxOrErr/Tx/Pmt/IntBkSttlmAmt/AmtWthCcy	EUR 100000.00
Type Proprietary	LIIA

Message item	Utilisation
/Document/RtrTx/RptOrErr/BizRpt/TxRpt/TxOrErr/Tx/Pmt/Tp/Prtry	
End To End Identification	Inc050b050-E2EId
/Document/RtrTx/RptOrErr/BizRpt/TxRpt/TxOrErr/Tx/Pmt/EndToEndId	
Business Report – Transaction Report – Transaction – Account Entry	
Account Identification	MDEEURSOLADESTXXXSOLADESTXXX
/Document/RtrTx/RptOrErr/BizRpt/TxRpt/TxOrErr/Tx/AcctNtry/Acct/Id/Othr/Id	
Account Owner Name	Landesbank Baden-Wuerttemberg, Stuttgart
/Document/RtrTx/RptOrErr/BizRpt/TxRpt/TxOrErr/Tx/AcctNtry/Acct/Ownr/Nm	
Account Owner BIC	SOLADESTXXX
/Document/RtrTx/RptOrErr/BizRpt/TxRpt/TxOrErr/Tx/AcctNtry/Acct/Ownr/Id/OrgId/AnyBIC	
Entry Amount	EUR 100000.00
/Document/RtrTx/RptOrErr/BizRpt/TxRpt/TxOrErr/Tx/AcctNtry/Ntry/Amt	
Entry Date Time	2019-10-08T14:19:00.001+00:00
/Document/RtrTx/RptOrErr/BizRpt/TxRpt/TxOrErr/Tx/AcctNtry/Ntry/Dt/DtTm	
Business Report – Transaction Report	
Payment Identification	CLM-p009b004
/Document/RtrTx/RptOrErr/BizRpt/TxRpt/PmtId/PrtryId	
Credit Debit Indicator	DBIT
/Document/RtrTx/RptOrErr/BizRpt/TxRpt/TxOrErr/Tx/CdtDbtInd	
Business Report – Transaction Report – Transaction – Payment	
Status Code Pending	ACPD
/Document/RtrTx/RptOrErr/BizRpt/TxRpt/TxOrErr/Tx/Pmt/Stats/Cd/Pdg	
Interbank Settlement Amount	EUR 285000.00

Message item	Utilisation
/Document/RtrTx/RptOrErr/BizRpt/TxRpt/TxOrErr/Tx/Pmt/IntrBkSttlmAmt/AmtWthCcy	
Type Proprietary	OCBO
/Document/RtrTx/RptOrErr/BizRpt/TxRpt/TxOrErr/Tx/Pmt/Tp/Prtry	
End To End Identification	Inp009b004-E2EId
/Document/RtrTx/RptOrErr/BizRpt/TxRpt/TxOrErr/Tx/Pmt/EndToEndId	
Business Report – Transaction Report – Transaction – Account Entry	
Account Identification	MDEEURMARKDEFFXXXMARKDEFFXXX
/Document/RtrTx/RptOrErr/BizRpt/TxRpt/TxOrErr/Tx/AcctNtry/Acct/Id/Othr/Id	
Account Owner Name	Deutsche Bundesbank
/Document/RtrTx/RptOrErr/BizRpt/TxRpt/TxOrErr/Tx/AcctNtry/Acct/Ownr/Nm	
Account Owner BIC	MARKDEFFXXX
/Document/RtrTx/RptOrErr/BizRpt/TxRpt/TxOrErr/Tx/AcctNtry/Acct/Ownr/Id/OrgId/AnyBIC	
Business Report – Transaction Report	
Payment Identification	CLM-p009b004
/Document/RtrTx/RptOrErr/BizRpt/TxRpt/PmtId/PrtryId	
Credit Debit Indicator	CRDT
/Document/RtrTx/RptOrErr/BizRpt/TxRpt/TxOrErr/Tx/CdtDbtInd	
Business Report – Transaction Report – Transaction – Payment	
Status Code Pending	ACPD
/Document/RtrTx/RptOrErr/BizRpt/TxRpt/TxOrErr/Tx/Pmt/Stats/Cd/Pdg	
Interbank Settlement Amount	EUR 285000.00
/Document/RtrTx/RptOrErr/BizRpt/TxRpt/TxOrErr/Tx/Pmt/IntrBkSttlmAmt/AmtWthCcy	
Type Proprietary	OCBO

Message item	Utilisation
/Document/RtrTx/RptOrErr/BizRpt/TxRpt/TxOrErr/Tx/Pmt/Tp/Prtry	
End To End Identification	Inp009b004-E2EId
/Document/RtrTx/RptOrErr/BizRpt/TxRpt/TxOrErr/Tx/Pmt/EndToEndId	
Business Report – Transaction Report – Transaction – Account Entry	
Account Identification	MDEEURSOLADESTXXXSOLADESTXXX
/Document/RtrTx/RptOrErr/BizRpt/TxRpt/TxOrErr/Tx/AcctNtry/Acct/Id/Othr/Id	
Account Owner Name	Landesbank Baden-Wuerttemberg, Stuttgart
/Document/RtrTx/RptOrErr/BizRpt/TxRpt/TxOrErr/Tx/AcctNtry/Acct/Ownr/Nm	
Account Owner BIC	SOLADESTXXX
/Document/RtrTx/RptOrErr/BizRpt/TxRpt/TxOrErr/Tx/AcctNtry/Acct/Ownr/Id/OrgId/AnyBIC	

Table 144 - ReturnTransaction (camt.006) – usage case CB requesting all transactions (Scenario 107)

Usage case example: camt.006_CLM_ReturnTransaction_bs107.xml

Usage case: CLM Return Transaction camt.006 (Scenario 108)

In this example, CLM is showing all available data which relate to the transaction that was explicitly identified in the query. The transaction itself was created in bs004 (pacs.009).

Message item	Utilisation
Message Header	
Message Identification	NONREF
/Document/RtrTx/MsgHdr/MsgId	
Original Business Query	Inc005b108-BAHId
/Document/RtrTx/MsgHdr/OrgnlBizQry/MsgId	
Business Report – Transaction Report	
Payment Identification	CLM-p009b004
/Document/RtrTx/RptOrErr/BizRpt/TxRpt/PmtId/PrtryId	
Business Report – Transaction Report – Transaction – Payment To	

Message item	Utilisation
Payment To BIC /Document/RtrTx/RptOrErr/BizRpt/TxRpt/TxOrErr/Tx/PmtTo /Mmbld/FinInstnld/BICFI	TRGTXEPMCLM
Payment To Country /Document/RtrTx/RptOrErr/BizRpt/TxRpt/TxOrErr/Tx/PmtTo /Ctry	DE
Business Report – Transaction Report – Transaction – Payment From	
Payment From BIC /Document/RtrTx/RptOrErr/BizRpt/TxRpt/TxOrErr/Tx/PmtFr /Mmbld/FinInstnld/BICFI	MARKDEFFXXX
Credit Debit Indicator /Document/RtrTx/RptOrErr/BizRpt/TxRpt/TxOrErr/Tx/CdtDb tInd	DBIT
Business Report – Transaction Report – Transaction – Payment	
Requested Execution Date /Document/RtrTx/RptOrErr/BizRpt/TxRpt/TxOrErr/Tx/Pmt/R eqdExctnDt/Dt	2019-10-09
Status Code Final /Document/RtrTx/RptOrErr/BizRpt/TxRpt/TxOrErr/Tx/Pmt/S ts/Cd/Fnl	STLD
Interbank Settlement Amount /Document/RtrTx/RptOrErr/BizRpt/TxRpt/TxOrErr/Tx/Pmt/In trBkSttlmAmt/AmtWthCcy	EUR 285000.00
Payment Method XML Message Name /Document/RtrTx/RptOrErr/BizRpt/TxRpt/TxOrErr/Tx/Pmt/P mtMtd/XMLMsgNm	pacs.009.001.08
Instruction Copy /Document/RtrTx/RptOrErr/BizRpt/TxRpt/TxOrErr/Tx/Pmt/In strCpy	<![CDATA[<AppHdr xmlns="urn:iso:std:iso:20022:tech:xsd:head.001.001.01" xmlns:xsi="http://www.w3.org/2001/XMLSchema-instance" xsi:schemaLocation="urn:iso:std:iso:20022:tech:xsd:head.0 01.001.01 CLM_BusinessApplicationHeader_head_001_BusinessApp licationHeader_head_001_001_01_20191021_1601.xsd">

Message item	Utilisation
	<pre> <Fr><FIld><FinInstnId><BICFI>MARKDEFFXXX</BICFI>< ClrSysMmbld><Mmbld>BizSenderb010UserId</Mmbld></ ClrSysMmbld></FinInstnId></FIld></Fr><To><FIld><FinIn stnId><BICFI>TRGTXEPMCLM</BICFI></FinInstnId></FI ld></To><BizMsgldr>Inp009b004- BAHId</BizMsgldr><MsgDefldr>pacs.009.001.08</MsgDef ldr><CreDt>2019-10- 07T14:15:00Z</CreDt></AppHdr><Document xmlns="urn:iso:std:iso:20022:tech:xsd:pacs.009.001.08" xmlns:xsi="http://www.w3.org/2001/XMLSchema-instance" xsi:schemaLocation="urn:iso:std:iso:20022:tech:xsd:pacs.0 09.001.08 CLM_pacs_guidelines_pacs_009_FIToFIFinancialInstitutio nCreditTransfer_pacs_009_001_08_20191021_1533.xsd"> <FICdtTrf><GrpHdr><Msgld>NONREF</Msgld><CreDtTm >2019-10- 07T14:15:00+00:00</CreDtTm><NbOfTxes>1</NbOfTxes>< SttlmInf><SttlmMtd>CLRG</SttlmMtd><ClrSys><Cd>TGT< /Cd></ClrSys></SttlmInf></GrpHdr><CdtTrfTxInf><PmtId> <InstrId>Inp009b004- InsId</InstrId><EndToEndId>Inp009b004- E2EId</EndToEndId><UETR>e009b004-59c5-41e9-be4c- d45102fc201e</UETR></PmtId><IntrBkSttlmAmt Ccy="EUR">285000.00</IntrBkSttlmAmt><IntrBkSttlmDt>2 019-10- 09</IntrBkSttlmDt><InstgAgt><FinInstnId><BICFI>MARKD EFFXXX</BICFI></FinInstnId></InstgAgt><InstgAgt><FinI nstnId><BICFI>SOLADESTXXX</BICFI></FinInstnId></Ins tdAgt><Dbtr><FinInstnId><BICFI>MARKDEFFXXX</BICFI ></FinInstnId></Dbtr><Cdtr><FinInstnId><BICFI>SOLADE STXXX</BICFI></FinInstnId></Cdtr></CdtTrfTxInf></FICdt Trf></Document>]]> </pre>
Type Proprietary	OCBO
/Document/RtrTx/RptOrErr/BizRpt/TxRpt/TxOrErr/Tx/Pmt/Tp/Prtry	
Inter Bank Settlement Date	2019-10-09
/Document/RtrTx/RptOrErr/BizRpt/TxRpt/TxOrErr/Tx/Pmt/IntrBkSttlmDt	

Message item	Utilisation
End To End Identification /Document/RtrTx/RptOrErr/BizRpt/TxRpt/TxOrErr/Tx/Pmt/EndToEndId	Inp009b004-E2EId
Business Report – Transaction Report – Transaction – Payment – Parties	
Instructing Agent BIC /Document/RtrTx/RptOrErr/BizRpt/TxRpt/TxOrErr/Tx/Pmt/Parties/InstgAgt/FinInstnId/BICFI	MARKDEFFXXX
Instructed Agent BIC /Document/RtrTx/RptOrErr/BizRpt/TxRpt/TxOrErr/Tx/Pmt/Parties/InstdAgt/FinInstnId/BICFI	SOLADESTXXX
Business Report – Transaction Report – Transaction – Payment – Parties – Debtor	
Debtor BIC /Document/RtrTx/RptOrErr/BizRpt/TxRpt/TxOrErr/Tx/Pmt/Parties/Dbtr/Pty/Id/OrgId/AnyBIC	MARKDEFFXXX
Business Report – Transaction Report – Transaction – Payment – Parties – Creditor	
Creditor BIC /Document/RtrTx/RptOrErr/BizRpt/TxRpt/TxOrErr/Tx/Pmt/Parties/Cdtr/Pty//Id/OrgId/AnyBIC	SOLADESTXXX
Business Report – Transaction Report – Transaction – Account Entry	
Account Identification /Document/RtrTx/RptOrErr/BizRpt/TxRpt/TxOrErr/Tx/AcctNtry/Acct/Id/Othr/Id	MDEEURMARKDEFFXXXMARKDEFFXXX
Account Owner Name /Document/RtrTx/RptOrErr/BizRpt/TxRpt/TxOrErr/Tx/AcctNtry/Acct/Ownr/Nm	Deutsche Bundesbank

Message item	Utilisation
Account Owner BIC /Document/RtrTx/RptOrErr/BizRpt/TxRpt/TxOrErr/Tx/AcctNtry/Acct/Ownr/Id/OrgId/AnyBIC	MARKDEFFXXX
Entry Amount /Document/RtrTx/RptOrErr/BizRpt/TxRpt/TxOrErr/Tx/AcctNtry/Ntry/Amt	EUR 285000.00
Entry Date Time /Document/RtrTx/RptOrErr/BizRpt/TxRpt/TxOrErr/Tx/AcctNtry/Ntry/Dt/DtTm	2019-10-09T07:25:00.001+00:00

Table 145 - ReturnTransaction (camt.006) – usage case CB requesting a single transaction with all fields (Scenario 108)

Usage case example: camt.006_CLM_ReturnTransaction_bs108.xml

Usage case: CLM Return Transaction camt.006 (Scenario 109)

In this example, CLM is showing all transactions fulfilling the query criteria in the provided query message. The account involved is a marginal lending account owned by the query-sending CB.

The transactions listed arise from activity within bs073 (automated marginal lending) and show an automated return during start of day processing and an interest payment during the late afternoon.

Message item	Utilisation
Message Header	
Message Identification /Document/RtrTx/MsgHdr/MsgId	NONREF
Original Business Query /Document/RtrTx/MsgHdr/OrgnBizQry/MsgId	Inc005b109-BAHId
Business Report – Transaction Report	
Payment Identification /Document/RtrTx/RptOrErr/BizRpt/TxRpt/PmtId/PrtryId	CLM-AMLRb073
Credit Debit Indicator /Document/RtrTx/RptOrErr/BizRpt/TxRpt/TxOrErr/Tx/CdtDbtInd	CRDT
Type Proprietary /Document/RtrTx/RptOrErr/BizRpt/TxRpt/TxOrErr/Tx/Pmt/T	AMLR

Message item	Utilisation
p/Prtry	
Business Report – Transaction Report – Transaction – Account Entry	
Account Identification /Document/RtrTx/RptOrErr/BizRpt/TxRpt/TxOrErr/Tx/AcctNtry/Acct/Id/Othr/Id	LDEEURCOBADEFFXXX0001
Account Owner Name /Document/RtrTx/RptOrErr/BizRpt/TxRpt/TxOrErr/Tx/AcctNtry/Acct/Ownr/Nm	Deutsche Bundesbank
Account Owner BIC /Document/RtrTx/RptOrErr/BizRpt/TxRpt/TxOrErr/Tx/AcctNtry/Acct/Ownr/Id/OrgId/AnyBIC	MARKDEFFXXX
Entry Amount /Document/RtrTx/RptOrErr/BizRpt/TxRpt/TxOrErr/Tx/AcctNtry/Ntry/Amt	EUR 117000.00
Entry Date Time /Document/RtrTx/RptOrErr/BizRpt/TxRpt/TxOrErr/Tx/AcctNtry/Ntry/Dt/DtTm	2019-10-07T19:15:01.000+00:00
Business Report – Transaction Report	
Payment Identification /Document/RtrTx/RptOrErr/BizRpt/TxRpt/PmtId/PrtryId	CLM-MLINb073
Credit Debit Indicator /Document/RtrTx/RptOrErr/BizRpt/TxRpt/TxOrErr/Tx/CdtDbtInd	CRDT
Business Report – Transaction Report – Transaction – Payment	
Type Proprietary /Document/RtrTx/RptOrErr/BizRpt/TxRpt/TxOrErr/Tx/Pmt/Tp/Prtry	MLIN
Business Report – Transaction Report – Transaction – Account Entry	
Account Identification /Document/RtrTx/RptOrErr/BizRpt/TxRpt/TxOrErr/Tx/AcctNtry/Acct/Id/Othr/Id	LDEEURCOBADEFFXXX0001
Account Owner Name	Deutsche Bundesbank

Message item	Utilisation
/Document/RtrTx/RptOrErr/BizRpt/TxRpt/TxOrErr/Tx/AcctNtry/Acct/Ownr/Nm	
Account Owner BIC /Document/RtrTx/RptOrErr/BizRpt/TxRpt/TxOrErr/Tx/AcctNtry/Acct/Ownr/Id/OrgId/AnyBIC	MARKDEFFXXX
Entry Amount /Document/RtrTx/RptOrErr/BizRpt/TxRpt/TxOrErr/Tx/AcctNtry/Ntry/Amt	EUR 117.00
Entry Date Time /Document/RtrTx/RptOrErr/BizRpt/TxRpt/TxOrErr/Tx/AcctNtry/Ntry/Dt/DtTm	2019-10-08T16:00:00.000+00:00

Table 146 - ReturnTransaction (camt.006) – usage case CB requesting marginal lending accounts (Scenario 109)

Usage case example: camt.006_CLM_ReturnTransaction_bs109.xml

12.2.5 GetBusinessDayInformation (camt.018)

12.2.5.1 Overview and scope of the message

This chapter illustrates the *GetBusinessDayInformation* message.

The *GetBusinessDayInformation* message is sent by a business sender to CLM. It is used to request the system date and time or information about different business day events linked to CLM.

The message can be sent by the following business sender:

- I CLM Account Holder;
- I CB.

The usage of this message is to be found in chapter [Usage of Messages](#) [▶ 324].

In response to the *GetBusinessDayInformation* message, a [ReturnBusinessDayInformation \(camt.019\)](#) [▶ 469] message containing either the requested information or business validation error(s) is returned to the business sender.

12.2.5.2 Schema

Outline of the schema

The *GetBusinessDayInformation* message is composed of the following message building blocks.

MessageHeader

This building block is mandatory and non-repetitive. The identification by the business sender to uniquely and unambiguously identify the message is part of the BAH, therefore the content of message ID is "NONREF".

RequestType

This building block is optional and only used in the case of a SystemTimeEnquiry. In the case of querying the active system events the RequestType is not used. It includes the element:

- | enquiry

References/links

The CLM-specific schema and documentation in XSD/Excel/PDF format as well as the message examples are provided outside of this document under the following link:

http://www.swift.com/mystandards/CLM/camt.018.001.05_CLM

Business rules applicable to the schema

For business rules applicable to *GetBusinessDayInformation* refer to the chapter [Index of validation rules and error codes](#) [▶ 643].

12.2.5.3 The message in business context

Specific message requirements

All content must comply with the business rules for the message. For business rules applicable to *GetBusinessDayInformation* refer to the chapter [Index of validation rules and error codes](#) [▶ 643].

Message item	Utilisation
Message Header	
Message Identification /Document/GetBizDayInf/MsgHdr/MsgId	Value "NONREF" as the message ID is already part of the BAH
Request Type	
Enquiry /Document/GetBizDayInf/MsgHdr/ReqTp/Enqry	For CLM system time query: RT16 = SystemTimeEnquiry

Table 147 - GetBusinessDayInformation (camt.018)

Usage case: Query Request Message - System Time Query (Scenario 057)

In this usage example, the business sender is using an enquiry code of RT16 to indicate that only the system time is required:

Message item	Utilisation
Message Identification /Document/GetBizDayInf/MsgHdr/MsgId	NONREF
Enquiry /Document/GetBizDayInf/MsgHdr/ReqTp/Enqry	RT16

Table 148 - GetBusinessDayInformation (camt.018) – usage case Query Request Message - System Time Query (Scenario 057)

Usage case example: camt.018_CLM_CurrentSystemTimeQuery_RT16_bs057.xml

Usage case: Query Request Message - Event Query (Scenario 058)

In this example, the business sender is using an empty camt.018 message to indicate that status information for all CLM events is requested. Although not included in the camt.018, the query time used to generate the camt.019 response was around 20:00 on Monday 2019-10-07.

Message item	Utilisation
Message Identification /Document/GetBizDayInf/MsgHdr/MsgId	NONREF

Table 149 - GetBusinessDayInformation (camt.018) – usage case Query Request Message - Event Query (Optional Maintenance Window) (Scenario 058)

Usage case example: camt.018_CLM_CurrentEventQuery_bs058.xml

Usage case: Query Request Message - Event Query (Scenario 071)

In this example, the business sender is using an empty camt.018 message to indicate that status information for all CLM events is requested. Although not included in the camt.018, the query time used to generate the camt.019 response was around 20:00 on Friday 2019-10-04.

Message item	Utilisation
Message Identification	NONREF
/Document/GetBizDayInf/MsgHdr/MsgId	

Table 150 - GetBusinessDayInformation (camt.018) – CLM camt.018 request for event status information (non-optional Maintenance Window) (Scenario 071)

Usage case example: camt.018_CLM_CurrentEventQuery_bs071.xml

12.2.6 ReturnBusinessDayInformation (camt.019)

12.2.6.1 Overview and scope of the message

This chapter illustrates the *ReturnBusinessDayInformation* message.

The *ReturnBusinessDayInformation* message is sent by CLM either in response to a [GetBusinessDayInformation \(camt.018\)](#) [▶ 466] message, as a push notification or to coordinate general ledger creation (internal system use).

As a response to a *GetBusinessDayInformation* message, it is used to provide the system date and time or information about the details of business day events linked to CLM.

As a push notification it is used to provide details relating to the triggering business event.

As a coordination for general ledger, it is used to coordinate the general ledger creation process with other settlement services (internal system use).

The usage of this message is to be found in chapter [Usage of Messages](#) [▶ 324].

In the case of business validation error(s) on a query, CLM returns the *ReturnBusinessDayInformation* message containing the respective error code(s) and error description(s) to the business receiver.

12.2.6.2 Schema

Outline of the schema

The *ReturnBusinessDayInformation* message is composed of the following message building blocks.

MessageHeader

This building block is mandatory and non-repetitive. The identification by the business sender to uniquely and unambiguously identify the message is part of the BAH, therefore the content of message ID is "NONREF".

ReportOrError

This building block is mandatory and non-repetitive. It contains either the information matching the search criteria of the related business query about business day information or an error indication.

BusinessDayOrError

This building block reports either the system availability for a specific business day or business error when information has not been found. When it reports the business day information, it may contain:

- | system identification;
- | business day information (system date and system information per currency).

References/links

The CLM-specific schema and documentation in XSD/Excel/PDF as well as the message examples are provided outside of this document under the following link:

http://www.swift.com/mystandards/CLM/camt.019.001.07_CLM

Business rules applicable to the schema

No business rules are applicable to a *ReturnBusinessDayInformation* message.

12.2.6.3 The message in business context

Specific message contents

Message item	Utilisation
Message Header	
Message Identification /Document/RtrBizDayInf/MsgHdr/MsgId	Value "NONREF" as the message ID is already part of the BAH
Message Identification /Document/RtrBizDayInf/MsgHdr/OrgnlBizQry/MsgId	BizMsgIdr of the GetBusinessDayInformation (camt.018) [466] copied from the BAH
Report Or Error	
System Identification /Document/RtrBizDayInf/RptOrErr/BizRpt/SysId/MktInfrstrct rld/Cd	Identification of a particular market infrastructure. CLM = CLM

Message item	Utilisation
System Date /Document/RtrBizDayInf/RptOrErr/BizRpt/BizDayOrErr/BizDayInf/SysDt/Dt	Indicates the date of the business day related to the currency of the business sender of the inbound camt.018 query or the subscribing party in the case the camt.019 is sent in push mode.
System Date Time /Document/RtrBizDayInf/RptOrErr/BizRpt/BizDayOrErr/BizDayInf/SysDt/DtTm	For system time query: Used to indicate the current system date and time.
System Currency /Document/RtrBizDayInf/RptOrErr/BizRpt/BizDayOrErr/BizDayInf/SysInfPerCcy/SysCcy	System currency is used only if currency specific event codes are provided.
Event /Document/RtrBizDayInf/RptOrErr/BizRpt/BizDayOrErr/BizDayInf/SysInfPerCcy/Evt/Tp/Prtry/Id	Please find the event code list in CLM UDFS section List of events [91].
Scheduled Time /Document/RtrBizDayInf/RptOrErr/BizRpt/BizDayOrErr/BizDayInf/SysInfPerCcy/Evt/SchldIdTm	For time-based events the planned or revised event times will be reported. Non time-based events will be reported with date-time 9999-01-01T00:00:00.000+00:00
Effective Time /Document/RtrBizDayInf/RptOrErr/BizRpt/BizDayOrErr/BizDayInf/SysInfPerCcy/Evt/FctvTm	Effective time is only used if planned or revised time is reached. Otherwise element is not used. In the case of cut-off events the scheduled and effective times are identical.
Operational Error /Document/RtrBizDayInf/RptOrErr/OprlErr/Err/Prtry	For further detailed information refer to chapter Index of validation rules and error codes [643].
Operational Error Description /Document/RtrBizDayInf/RptOrErr/OprlErr/Desc	Specification of the error, in free format.

Table 151 - ReturnBusinessDayInformation (camt.019)

Usage case: Query Response For Business Data - System Time Query (Scenario 057)

In this usage example, CLM is responding with the system time to the business sender of a valid camt.018 system-time query. The BAH business identification of the camt.018 is included for recognition.

Message item	Utilisation
Message Identification /Document/RtrBizDayInf/MsgHdr/MsgId	NONREF
Message Identification /Document/RtrBizDayInf/MsgHdr/OrgnBizQry/MsgId	Inc018b057-BAHId
System Identification /Document/RtrBizDayInf/RptOrErr/BizRpt/SysId/MktInfrstrct rId/Cd	CLM
System Date Time /Document/RtrBizDayInf/RptOrErr/BizRpt/BizDayOrErr/Biz DayInf/SysDt/DtTm	2019-10-08T09:30:47.001+00:00

Table 152 - ReturnBusinessDayInformation (camt.019) – Query Response For Business Data - System Time Query (Scenario 057)

Usage case example: camt.019_CLM_CurrentSystemTimeQueryResponse_RT16_bs057.xml

Usage case: CLM camt.018 request for event status information (Optional Maintenance Window) (Scenario 058)

Usage case: QueryCLM camt.018 request for event status information (Optional Maintenance Window) (Scenario 058)

In this example, CLM is responding to the business sender of a valid camt.018 event query. The BAH business ID of the camt.018 is included for recognition. For this business scenario, it is assumed that the query was sent and executed at around 20:00 on Monday, 2019-10-07.

The response shows all currency-dependent events (for EUR). On this day no currency specific closing is planned. The scheduled time for each event is given, but for the events which have already occurred before the query-time, the actual (effective) event time is also provided.

Message item	Utilisation
Message Identification /Document/RtrBizDayInf/MsgHdr/MsgId	NONREF
Message Identification /Document/RtrBizDayInf/MsgHdr/OrgnBizQry/MsgId	Inc018b058-BAHId
System Identification /Document/RtrBizDayInf/RptOrErr/BizRpt/SysId/MktInfrstrct rId/Cd	CLM

Fehler! Verwenden Sie die Registerkarte 'Start', um dem Text zuzuweisen,

Message item	Utilisation
System Currency /Document/RtrBizDayInf/RptOrErr/BizRpt/BizDayOrErr/BizDayInf/SysInfPerCcy/SysCcy	EUR
Event /Document/RtrBizDayInf/RptOrErr/BizRpt/BizDayOrErr/BizDayInf/SysInfPerCcy/Evt/Tp/Prtry/Id	CSOD
Scheduled Time /Document/RtrBizDayInf/RptOrErr/BizRpt/BizDayOrErr/BizDayInf/SysInfPerCcy/Evt/SchldIdTm	2019-10-07T18:45:00.000+00:00
Effective Time /Document/RtrBizDayInf/RptOrErr/BizRpt/BizDayOrErr/BizDayInf/SysInfPerCcy/Evt/FctvTm	2019-10-07T18:45:00.010+00:00
Event /Document/RtrBizDayInf/RptOrErr/BizRpt/BizDayOrErr/BizDayInf/SysInfPerCcy/Evt/Tp/Prtry/Id	CRTI
Scheduled Time /Document/RtrBizDayInf/RptOrErr/BizRpt/BizDayOrErr/BizDayInf/SysInfPerCcy/Evt/SchldIdTm	2019-10-07T19:00:00.000+00:00
Effective Time /Document/RtrBizDayInf/RptOrErr/BizRpt/BizDayOrErr/BizDayInf/SysInfPerCcy/Evt/FctvTm	2019-10-07T19:00:00.005+00:00
Event /Document/RtrBizDayInf/RptOrErr/BizRpt/BizDayOrErr/BizDayInf/SysInfPerCcy/Evt/Tp/Prtry/Id	CESO
Scheduled Time /Document/RtrBizDayInf/RptOrErr/BizRpt/BizDayOrErr/BizDayInf/SysInfPerCcy/Evt/SchldIdTm	2019-10-07T19:30:00.000+00:00
Effective Time /Document/RtrBizDayInf/RptOrErr/BizRpt/BizDayOrErr/BizDayInf/SysInfPerCcy/Evt/FctvTm	2019-10-07T19:32:00.000+00:00
Event /Document/RtrBizDayInf/RptOrErr/BizRpt/BizDayOrErr/BizDayInf/SysInfPerCcy/Evt/Tp/Prtry/Id	CSOM

Message item	Utilisation
Scheduled Time /Document/RtrBizDayInf/RptOrErr/BizRpt/BizDayOrErr/BizDayInf/SysInfPerCcy/Evt/SchldIdTm	2019-10-08T03:00:00.000+00:00
Event /Document/RtrBizDayInf/RptOrErr/BizRpt/BizDayOrErr/BizDayInf/SysInfPerCcy/Evt/Tp/Prtry/Id	CEOM
Scheduled Time /Document/RtrBizDayInf/RptOrErr/BizRpt/BizDayOrErr/BizDayInf/SysInfPerCcy/Evt/SchldIdTm	2019-10-08T05:00:00.000+00:00
Event /Document/RtrBizDayInf/RptOrErr/BizRpt/BizDayOrErr/BizDayInf/SysInfPerCcy/Evt/Tp/Prtry/Id	T2D2
Scheduled Time /Document/RtrBizDayInf/RptOrErr/BizRpt/BizDayOrErr/BizDayInf/SysInfPerCcy/Evt/SchldIdTm	9999-01-01T00:00:00.000+00:00
Event /Document/RtrBizDayInf/RptOrErr/BizRpt/BizDayOrErr/BizDayInf/SysInfPerCcy/Evt/Tp/Prtry/Id	CCII
Scheduled Time /Document/RtrBizDayInf/RptOrErr/BizRpt/BizDayOrErr/BizDayInf/SysInfPerCcy/Evt/SchldIdTm	2019-10-08T18:00:00.000+00:00
Event /Document/RtrBizDayInf/RptOrErr/BizRpt/BizDayOrErr/BizDayInf/SysInfPerCcy/Evt/Tp/Prtry/Id	CEOD
Scheduled Time /Document/RtrBizDayInf/RptOrErr/BizRpt/BizDayOrErr/BizDayInf/SysInfPerCcy/Evt/SchldIdTm	9999-01-01T00:00:00.000+00:00
Event /Document/RtrBizDayInf/RptOrErr/BizRpt/BizDayOrErr/BizDayInf/SysInfPerCcy/Evt/Tp/Prtry/Id	CCSF
Scheduled Time /Document/RtrBizDayInf/RptOrErr/BizRpt/BizDayOrErr/BizDayInf/SysInfPerCcy/Evt/SchldIdTm	2019-10-08T18:15:00.000+00:00

Message item	Utilisation
Event /Document/RtrBizDayInf/RptOrErr/BizRpt/BizDayOrErr/BizDayInf/SysInfPerCcy/Evt/Tp/Prtry/Id	CCML
Scheduled Time /Document/RtrBizDayInf/RptOrErr/BizRpt/BizDayOrErr/BizDayInf/SysInfPerCcy/Evt/SchldTm	2019-10-08T18:40:00.000+00:00
Event /Document/RtrBizDayInf/RptOrErr/BizRpt/BizDayOrErr/BizDayInf/SysInfPerCcy/Evt/Tp/Prtry/Id	CCOS
Scheduled Time /Document/RtrBizDayInf/RptOrErr/BizRpt/BizDayOrErr/BizDayInf/SysInfPerCcy/Evt/SchldTm	9999-01-01T00:00:00.000+00:00

Table 153 - ReturnBusinessDayInformation (camt.019) – camt.018 Request for event status information (Optional Maintenance Window) (Scenario 058)

Usage case example: camt.019_CLM_CurrentEventQueryResponse_Data_bs058.xml

Usage case: System Notification (Scenario 059)

In this example, CLM has automatically generated a camt.019 to inform the business receiver that the event “CSOD” (CLM SoD) occurred at 18:45:00.0010 as indicated in the effective timestamp field. This was micro-seconds later than the scheduled time.

Note: Unlike the camt.019 event query response, a system generated camt.019 will only ever provide information for one event.

Message item	Utilisation
Message Identification /Document/RtrBizDayInf/MsgHdr/Msgld	NONREF
Message Identification /Document/RtrBizDayInf/MsgHdr/OrgnlBizQry/Msgld	NONREF
System Identification /Document/RtrBizDayInf/RptOrErr/BizRpt/SysId/MktInfrstrct rld/Cd	CLM
System Currency /Document/RtrBizDayInf/RptOrErr/BizRpt/BizDayOrErr/Biz	EUR

Message item	Utilisation
DayInf/SysInfPerCcy/SysCcy	
Event /Document/RtrBizDayInf/RptOrErr/BizRpt/BizDayOrErr/BizDayInf/SysInfPerCcy/Evt/Tp/Prtry/Id	CSOD
Scheduled Time /Document/RtrBizDayInf/RptOrErr/BizRpt/BizDayOrErr/BizDayInf/SysInfPerCcy/Evt/SchdldTm	2019-10-07T18:45:00.000+00:00
Effective Time /Document/RtrBizDayInf/RptOrErr/BizRpt/BizDayOrErr/BizDayInf/SysInfPerCcy/Evt/FctvTm	2019-10-07T18:45:00.010+00:00

Table 154 - ReturnBusinessDayInformation (camt.019) – usage case System Notification (Scenario 059)

Usage case example: camt.019_CLM_CurrentEventNotification_CSOD_bs059.xml

Usage case: CLM camt.018 request for event status information (non-optional Maintenance Window) (Scenario 071)

In this example, CLM is responding to the business sender of a valid camt.018 event query. The BAH business id of the camt.018 is included for recognition. For this business scenario, it is assumed that the query was sent and executed at around 20:00 on Friday, 2019-10-04.

The response shows currency-dependent events (for EUR). On this day no currency specific closing is planned. The scheduled time for each event is given, but for the events which have already occurred before the query-time, the actual (effective) event time is also provided.

Message item	Utilisation
Message Identification /Document/RtrBizDayInf/MsgHdr/MsgId	NONREF
Message Identification /Document/RtrBizDayInf/MsgHdr/OrgnlBizQry/MsgId	Inc018b071-BAHId
System Identification /Document/RtrBizDayInf/RptOrErr/BizRpt/SysId/MktInfrstrctrlId/Cd	CLM
System Currency /Document/RtrBizDayInf/RptOrErr/BizRpt/BizDayOrErr/BizDayInf/SysInfPerCcy/SysCcy	EUR

Message item	Utilisation
Event /Document/RtrBizDayInf/RptOrErr/BizRpt/BizDayOrErr/BizDayInf/SysInfPerCcy/Evt/Tp/Prtry/Id	CSOD
Scheduled Time /Document/RtrBizDayInf/RptOrErr/BizRpt/BizDayOrErr/BizDayInf/SysInfPerCcy/Evt/SchldIdTm	2019-10-04T18:45:00.000+00:00
Effective Time /Document/RtrBizDayInf/RptOrErr/BizRpt/BizDayOrErr/BizDayInf/SysInfPerCcy/Evt/FctvTm	2019-10-04T18:45:00.010+00:00
Event /Document/RtrBizDayInf/RptOrErr/BizRpt/BizDayOrErr/BizDayInf/SysInfPerCcy/Evt/Tp/Prtry/Id	CRTI
Scheduled Time /Document/RtrBizDayInf/RptOrErr/BizRpt/BizDayOrErr/BizDayInf/SysInfPerCcy/Evt/SchldIdTm	2019-10-04T19:00:00.000+00:00
Effective Time /Document/RtrBizDayInf/RptOrErr/BizRpt/BizDayOrErr/BizDayInf/SysInfPerCcy/Evt/FctvTm	2019-10-04T19:00:00.005+00:00
Event /Document/RtrBizDayInf/RptOrErr/BizRpt/BizDayOrErr/BizDayInf/SysInfPerCcy/Evt/Tp/Prtry/Id	CESO
Scheduled Time /Document/RtrBizDayInf/RptOrErr/BizRpt/BizDayOrErr/BizDayInf/SysInfPerCcy/Evt/SchldIdTm	2019-10-04T19:30:00.000+00:00
Effective Time /Document/RtrBizDayInf/RptOrErr/BizRpt/BizDayOrErr/BizDayInf/SysInfPerCcy/Evt/FctvTm	2019-10-04T19:32:00.000+00:00
Event /Document/RtrBizDayInf/RptOrErr/BizRpt/BizDayOrErr/BizDayInf/SysInfPerCcy/Evt/Tp/Prtry/Id	CSMW
Scheduled Time /Document/RtrBizDayInf/RptOrErr/BizRpt/BizDayOrErr/BizDayInf/SysInfPerCcy/Evt/SchldIdTm	2019-10-05T02:30:00.000+00:00

Message item	Utilisation
Event /Document/RtrBizDayInf/RptOrErr/BizRpt/BizDayOrErr/BizDayInf/SysInfPerCcy/Evt/Tp/Prtry/Id	CEMW
Scheduled Time /Document/RtrBizDayInf/RptOrErr/BizRpt/BizDayOrErr/BizDayInf/SysInfPerCcy/Evt/SchldIdTm	2019-10-07T02:30:00.000+00:00
Event /Document/RtrBizDayInf/RptOrErr/BizRpt/BizDayOrErr/BizDayInf/SysInfPerCcy/Evt/Tp/Prtry/Id	T2D2
Scheduled Time /Document/RtrBizDayInf/RptOrErr/BizRpt/BizDayOrErr/BizDayInf/SysInfPerCcy/Evt/SchldIdTm	9999-01-01T00:00:00.000+00:00
Event /Document/RtrBizDayInf/RptOrErr/BizRpt/BizDayOrErr/BizDayInf/SysInfPerCcy/Evt/Tp/Prtry/Id	CCII
Scheduled Time /Document/RtrBizDayInf/RptOrErr/BizRpt/BizDayOrErr/BizDayInf/SysInfPerCcy/Evt/SchldIdTm	2019-10-07T18:00:00.000+00:00
Event /Document/RtrBizDayInf/RptOrErr/BizRpt/BizDayOrErr/BizDayInf/SysInfPerCcy/Evt/Tp/Prtry/Id	CEOD
Scheduled Time /Document/RtrBizDayInf/RptOrErr/BizRpt/BizDayOrErr/BizDayInf/SysInfPerCcy/Evt/SchldIdTm	9999-01-01T00:00:00.000+00:00
Event /Document/RtrBizDayInf/RptOrErr/BizRpt/BizDayOrErr/BizDayInf/SysInfPerCcy/Evt/Tp/Prtry/Id	CCSF
Scheduled Time /Document/RtrBizDayInf/RptOrErr/BizRpt/BizDayOrErr/BizDayInf/SysInfPerCcy/Evt/SchldIdTm	2019-10-07T18:15:00.000+00:00
Event /Document/RtrBizDayInf/RptOrErr/BizRpt/BizDayOrErr/BizDayInf/SysInfPerCcy/Evt/Tp/Prtry/Id	CCML

Message item	Utilisation
Scheduled Time /Document/RtrBizDayInf/RptOrErr/BizRpt/BizDayOrErr/BizDayInf/SysInfPerCcy/Evt/SchldIdTm	2019-10-07T18:40:00.000+00:00
Event /Document/RtrBizDayInf/RptOrErr/BizRpt/BizDayOrErr/BizDayInf/SysInfPerCcy/Evt/Tp/Prtry/Id	CCOS
Scheduled Time /Document/RtrBizDayInf/RptOrErr/BizRpt/BizDayOrErr/BizDayInf/SysInfPerCcy/Evt/SchldIdTm	9999-01-01T00:00:00.000+00:00

Table 155 - ReturnBusinessDayInformation (camt.019) – camt.018 request for event status information (non-optional Maintenance Window) (Scenario 071)

Usage case example: camt.019_CLM_CurrentEventQueryResponse_Data_bs071.xml

12.2.7 Receipt (camt.025)

12.2.7.1 Overview and scope of the message

This chapter illustrates the *Receipt* message.

The *Receipt* message is sent by CLM to the business sender of a previously sent inbound message. It is used to return a positive response or provide detailed information in case of an error.

Within CLM, the *Receipt* message is the response for the following messages:

- I [DeleteReservation \(camt.049\)](#) [▶ 502] and [ModifyReservation \(camt.048\)](#) [▶ 499] as a:
 - current reservation modification/deletion rejection notification;
 - current reservation modification/deletion execution notification;
 - current reservation modification queuing notification;
 - current reservation modification rejection notification.
- I [LiquidityCreditTransfer \(camt.050\)](#) [▶ 505] as a:
 - liquidity transfer order rejection notification;
 - liquidity transfer order fail notification;
 - liquidity transfer order settlement notification.
- I [ModifyCreditLine \(camt.998\) - specific for CBs](#) [▶ 580] - as a:
 - credit line modification rejection notification;

- credit line modification execution notification;
- credit line modification queuing notification.

l [Minimum reserve management \(camt.998\)](#) [▶ 584] as a:

- maintain minimum reserve requirement order rejection notification;
- maintain minimum reserve requirement execution notification;
- insert or adjust balance for minimum reserve fulfilment order rejection notification;
- insert or adjust balance for minimum reserve fulfilment execution notification;
- administrate minimum reserve penalty order rejection notification;
- administrate minimum reserve penalty order execution notification.

The usage of this message is to be found in chapter [Usage of Messages](#) [▶ 324].

Error codes and descriptions are defined in the appendix [Index of validation rules and error codes](#) [▶ 643].

12.2.7.2 Schema

Outline of the schema

The *Receipt* message is composed of the following message building blocks.

MessageHeader

This building block is mandatory and non-repetitive. The identification by the business sender to uniquely and unambiguously identify the message is part of the BAH, therefore the content of message ID is "NONREF".

ReceiptDetails

This building block is mandatory and non-repetitive. It provides information relating to the status of a previous instruction. It may contain:

- l request type;
- l original message identification;
- l request handling with status code and description.

References/links

The CLM-specific schema and documentation in XSD/Excel/PDF format as well as the message examples are provided outside of this document under the following link:

http://www.swift.com/mystandards/CLM/camt.025.001.05_CLM

Business rules applicable to the schema

No business rules are applicable to a *Receipt* message.

12.2.7.3 The message in business context

Specific message contents

Message item	Utilisation
Message Id Document/Rct/MsgHdr/MsgId	Value "NONREF" as the message ID is already part of the BAH
Request Type Document/Rct/MsgHdr/ReqTp/Prtry/Id	<ul style="list-style-type: none"> VSTS = Validation status SSTS = Settlement status XSTS = Execution status
Original message Identification /Document/Rct/RctDtls/OrgnMsgId/MsgId	Copy of the BizMsgldr used in the BAH of the inbound message sent to CLM.
Status Code /Document/Rct/RctDtls/ReqHdlg/StsCd	<p>If ReqTp = VSTS, then error code.</p> <p>If ReqTp = XSTS, then error code or PDNG (pending) or PPDN (partially pending) or COMP (completed).</p> <p>If ReqTp = SSTS, then error code or SSET (Settled).</p>
Description /Document/Rct/RctDtls/ReqHdlg/Desc	<p>If StsCd = Error code, then error description.</p> <p>Description for validation rule or error code (see chapter Index of validation rules and error codes [▶ 643]).</p>

Table 156 - Receipt (camt.025)

Usage case: Usage Of RequestType And Status

Request Type	Status Code	Description
Document/Rct/MsgHdr/ReqTp/Prtry/Id	Document/Rct/MsgHdr/ReqTp/Prtry/Id	Document/Rct/RctDtIs/ReqHdIg/Desc
VSTS (business validation status)	Error code	Error description
XSTS (execution status)	<ul style="list-style-type: none"> Error code PDNG (pending) PPDN (partially pending) COMP (completed) 	Error description when error code is used
SSTS (settlement status)	<ul style="list-style-type: none"> Error code SSET (settled) 	Error description when error code is used

Table 157 - Receipt (camt.025) – usage case Usage Of RequestType And Status

The RequestType “VSTS” is used whenever an inbound message fails one (or more) of the validation rules (see chapter [Index of validation rules and error codes](#) [▶ 643]). In such a case, the status Receipt (camt.025) is sent to the business sender of the original message, informing of all the validation failures found. The inbound message will not be processed any further. If the inbound message passes all validation rules, it is forwarded for processing.

RequestType “SSTS” is only used to report the settlement status of a LiquidityTransferOrder (camt.050), irrespective of the business function which generated it. Typically, camt.050 messages are settled immediately or rejected, i.e. a LiquidityTransferOrder status response will only ever be “Settled” or “Rejected with error code”.

RequestType “XSTS” is generic and covers any status code to describe the processing of a request to CLM which is not a liquidity transfer order. The actual list of status codes used depends upon the inbound message (business function) which triggered the camt.025.

RequestType and status combinations applicable to each inbound message

Fehler! Verwenden Sie die Registerkarte 'Start', um dem Text zuzuweisen,

RequestType: StatusCode: Meaning: Inbound message	VSTS x999 rejected	SSTS x999 failed	SSTS SSET settled	XSTS x999 failed	XSTS COMP completed	XSTS PDNG pending	XSTS PPDN partially-pend
ModifyReservation (camt.048) [▶ 499]	Yes	No	No	Yes	Yes	Yes	Yes
DeleteReservation (camt.049) [▶ 502]	Yes	No	No	Yes	Yes	Yes	Yes
LiquidityCreditTransfer (camt.050) [▶ 505]	Yes	Yes	Yes	No	No	No	No
ModifyCreditLine (camt.998) - specific for CBs [▶ 580]	Yes	No	No	Yes	Yes	Yes	No

RequestType: StatusCode: Meaning: Inbound message	VSTS x999 rejected	SSTS x999 failed	SSTS SSET settled	XSTS x999 failed	XSTS COMP completed	XSTS PDNG pending	XSTS PPDN partially-pend
InsertBalanceMinimumReserve (camt.998) - specific for CBs [604]	Yes	No	No	Yes	Yes	No	No
AuthorizePenaltyMinimumReserve (camt.998) - specific for CBs [584]	Yes	No	No	Yes	Yes	No	No
InsertValueOfReserveMinimumReserve (camt.998) - specific for CBs [600]	Yes	No	No	Yes	Yes	No	No

Table 158 - Receipt (camt.025) - CLM RequestType and Status combinations

Usage case: Current Reservation Modification Queuing Notification (Scenario 047)

In this usage example, CLM is advising the sender of a previous valid camt.048 that the request to modify the stated reservation has been accepted but cannot be executed yet so is in a pending state.

Message item	Utilisation
Message Id Document/Rct/MsgHdr/MsgId	NONREF
Identification /Document/Rct/MsgHdr/ReqTp/Prtry/Id	XSTS
Original message Identification /Document/Rct/RctDtIs/OrgnlMsgId/MsgId	Inc048b047-BAHId
Status Code /Document/Rct/RctDtIs/ReqHdlg/StsCd	PDNG

Table 159 - Receipt (camt.025) – usage case Current Reservation Modification Queuing Notification (Scenario 047)

Usage case example: camt.025_CLM_Receipt_XSTS_PDNG_bs047.xml

Usage case: Current Reservation Modification/Deletion Rejection Notification (Scenario 048)

In this usage example, CLM is advising the sender of a previous valid camt.049 that the request to delete the stated reservation cannot be executed now:

Message item	Utilisation
Message Id Document/Rct/MsgHdr/MsgId	NONREF
Identification /Document/Rct/MsgHdr/ReqTp/Prtry/Id	XSTS
Original message Identification /Document/Rct/RctDtIs/OrgnlMsgId/MsgId	Inc049b048-BAHId
Status Code /Document/Rct/RctDtIs/ReqHdlg/StsCd	E055
Description /Document/Rct/RctDtIs/ReqHdlg/Desc	Instruction not possible due to blocking account/party status

Table 160 - Receipt (camt.025) – usage case Current Reservation Modification/Deletion Rejection Notification (Scenario 048)

Usage case example: camt.025_CLM_Receipt_XSTS_ERROR_bs048.xml

Usage case: Current Reservation Modification/Deletion Execution Notification (Scenario 049)

In this usage example, CLM is advising the sender of a previous valid camt.049 that the request to delete the stated reservation is completed:

Message item	Utilisation
Message Id Document/Rct/MsgHdr/MsgId	NONREF
Identification /Document/Rct/MsgHdr/ReqTp/Prtry/Id	XSTS
Original message Identification /Document/Rct/RctDtIs/OrgnlMsgId/MsgId	Inc049b049-BAHId
Status Code /Document/Rct/RctDtIs/ReqHdlg/StsCd	COMP

Table 161 - Receipt (camt.025) – usage case Current Reservation Modification/Deletion Execution Notification (Scenario 049)

Usage case example: camt.025_CLM_Receipt_XSTS_COMP_bs049.xml

Usage case: Liquidity Transfer Order Settlement Notification (Scenario 050)

In this usage example, CLM is advising the sender of a previous camt.050 that liquidity order has been successfully settled:

Message item	Utilisation
Message Id Document/Rct/MsgHdr/MsgId	NONREF
Identification /Document/Rct/MsgHdr/ReqTp/Prtry/Id	SSTS
Original message Identification /Document/Rct/RctDtIs/OrgnlMsgId/MsgId	Inc050b050-BAHId
Status Code /Document/Rct/RctDtIs/ReqHdlg/StsCd	SSET

Table 162 - Receipt (camt.025) – usage case Liquidity Transfer Order Settlement Notification (Scenario 050)

Usage case example: camt.025_CLM_Receipt_SSTS_bs050.xml

Usage case: Liquidity Transfer Order Rejection Notification (Scenario 051)

In this usage example, CLM is advising the sender of a previous camt.050 that liquidity order has been rejected for the reason given. In this case, it is because the debit account does not have enough balance available:

Message item	Utilisation
Message Id Document/Rct/MsgHdr/MsgId	NONREF
Identification /Document/Rct/MsgHdr/ReqTp/Prtry/Id	VSTS
Original message Identification /Document/Rct/RctDtIs/OrgnlMsgId/MsgId	Inc050b051-BAHId
Status Code /Document/Rct/RctDtIs/ReqHdlg/StsCd	E042
Description /Document/Rct/RctDtIs/ReqHdlg/Desc	Insufficient liquidity to debit account

Table 163 - Receipt (camt.025) – usage case Liquidity Transfer Order Rejection Notification (Scenario 051)

Usage case example: camt.025_CLM_Receipt_VSTS_bs051.xml

Usage case: Credit Line Modification Execution Notification (Scenario 064)

In this usage example, CLM is advising the CB sender of the camt.998 *ModifyCreditLine* message that the requested action has been completed successfully.

Message item	Utilisation
Message Id Document/Rct/MsgHdr/MsgId	NONREF
Identification /Document/Rct/MsgHdr/ReqTp/Prtry/Id	XSTS
Original message Identification /Document/Rct/RctDtIs/OrgnlMsgId/MsgId	Inc998b064-BAHId
Status Code /Document/Rct/RctDtIs/ReqHdlg/StsCd	COMP

Table 164 - Receipt (camt.025) – usage case Credit Line Modification Execution Notification (Scenario 064)

Usage case example: camt.025_CLM_Receipt_XSTS_COMP_bs064.xml

Usage case: Credit Line Modification Execution Notification (Scenario 065)

In this usage example, CLM is advising the CB sender of the camt.998 *ModifyCreditLine* message that the requested action has been completed successfully.

Message item	Utilisation
Message Id Document/Rct/MsgHdr/MsgId	NONREF
Identification /Document/Rct/MsgHdr/ReqTp/Prtry/Id	XSTS
Original message Identification /Document/Rct/RctDtIs/OrgnIMsgId/MsgId	Inc998b065-BAHId
Status Code /Document/Rct/RctDtIs/ReqHdlg/StcCd	COMP

Table 165 - Receipt (camt.025) – usage case Credit Line Modification Execution Notification (Scenario 065)

Usage case example: camt.025_CLM_Receipt_XSTS_COMP_bs065.xml

Usage case: Liquidity Transfer Order Settlement Notification (Scenario 070)

In this example, CLM is informing the business sender of an inter-service camt.050 with inbound BAH reference of “Inc050b070-BAHId”, that the liquidity transfer has settled successfully.

Message item	Utilisation
Message Id Document/Rct/MsgHdr/MsgId	NONREF
Identification /Document/Rct/MsgHdr/ReqTp/Prtry/Id	SSTS
Original message Identification /Document/Rct/RctDtIs/OrgnIMsgId/MsgId	Inc050b070-BAHId
Status Code /Document/Rct/RctDtIs/ReqHdlg/StcCd	SSET

Table 166 - Receipt (camt.025) – usage case Liquidity Transfer Order Settlement Notification (Scenario 070)

Usage case example: camt.025_CLM_Receipt_SSTS_SSET_bs070.xml

Usage case: CLM camt.998 (AuthorisePenalty) is successful (Scenario 143)

In this example, CLM is advising the CB sender of the Authorise Penalty (camt.998-AuthorizePenaltyMinimumReserve) message that the requested action has been completed successfully.

Message item	Utilisation
Message Id Document/Rct/MsgHdr/MsgId	NONREF
Identification /Document/Rct/MsgHdr/ReqTp/Prtry/Id	XSTS
Original message Identification /Document/Rct/RctDtIs/OrgnlMsgId/MsgId	Inc998b143-BAHId
Status Code /Document/Rct/RctDtIs/ReqHdlg/StsCd	COMP

Table 167 - Receipt (camt.025) – usage case CLM camt.998 (AutorisePenalty) is successful (Scenario 143)

Usage case example: camt.025_CLM_Receipt_XSTS_COMP_bs143.xml

Usage case: CLM camt.998 (AuthorisePenalty) fails (Scenario 144)

In this example, CLM is advising the CB sender of a previous Authorise Penalty (camt.998-AuthorizePenaltyMinimumReserve) message that the request has been rejected for the reason given. In this case, the business rule code is “E105” with a description of “Invalid maintenance period”.

Message item	Utilisation
Message Id Document/Rct/MsgHdr/MsgId	NONREF
Identification /Document/Rct/MsgHdr/ReqTp/Prtry/Id	VSTS
Original message Identification /Document/Rct/RctDtIs/OrgnlMsgId/MsgId	Inc998b144-BAHId
Status Code /Document/Rct/RctDtIs/ReqHdlg/StsCd	E105
Description /Document/Rct/RctDtIs/ReqHdlg/Desc	Invalid maintenance period

Table 168 - Receipt (camt.025) – usage case CLM camt.998 (AutorisePenalty) fails (Scenario 144)

Usage case example: camt.025_CLM_Receipt_VSTS_bs144.xml

Usage case: CLM camt.998 (InsertValue) is successful (Scenario 147)

In this example, CLM is advising the CB sender of the Insert Value (camt.998-InsertValueOfMinimumReserve) message that the requested action has been completed successfully.

Message item	Utilisation
Message Id Document/Rct/MsgHdr/MsgId	NONREF
Identification /Document/Rct/MsgHdr/ReqTp/Prtry/Id	XSTS
Original message Identification /Document/Rct/RctDtIs/OrgnIMsgId/MsgId	Inc998b147-BAHId
Status Code /Document/Rct/RctDtIs/ReqHdlg/StcCd	COMP

Table 169 - Receipt (camt.025) – usage case CLM camt.998 (InsertValue) is successful (Scenario 147)

Usage case example: camt.025_CLM_Receipt_XSTS_COMP_bs147.xml

Usage case: CLM camt.998 (InsertValue) fails (Scenario 148)

In this example, CLM is advising the CB sender of a previous Insert Value (camt.998-InsertValueOfMinimumReserve) message that the request has been rejected for the reason given. In this case, the business rule code is “E105” with a description of “Invalid maintenance period”.

Message item	Utilisation
Message Id Document/Rct/MsgHdr/MsgId	NONREF
Identification /Document/Rct/MsgHdr/ReqTp/Prtry/Id	VSTS

Message item	Utilisation
Original message Identification /Document/Rct/RctDtls/OrgnlMsgld/Msgld	Inc998b148-BAHId
Status Code /Document/Rct/RctDtls/ReqHdlg/Stscd	E105
Description /Document/Rct/RctDtls/ReqHdlg/Desc	Invalid maintenance period

Table 170 - Receipt (camt.025) – usage case CLM camt.998 (InsertValue) fails (Scenario 148)

Usage case example: camt.025_CLM_Receipt_VSTS_bs148.xml

Usage case: CLM camt.998 (InsertBalance) is successful (Scenario 149)

In this example, CLM is advising the CB sender of the Insert Balance (camt.998-InsertBalanceMinimumReserve) message that the requested action has been completed successfully.

Message item	Utilisation
Message Id Document/Rct/MsgHdr/Msgld	NONREF
Identification /Document/Rct/MsgHdr/ReqTp/Prtry/Id	XSTS
Original message Identification /Document/Rct/RctDtls/OrgnlMsgld/Msgld	Inc998b149-BAHId
Status Code /Document/Rct/RctDtls/ReqHdlg/Stscd	COMP

Table 171 - Receipt (camt.025) – usage case CLM camt.998 (InsertBalance) is successful (Scenario 149)

Usage case example: camt.025_CLM_Receipt_XSTS_COMP_bs149.xml

Usage case: CLM camt.998 (InsertBalance) fails (Scenario 150)

In this example, CLM is advising the CB sender of a previous Insert Balance (camt.998-InsertBalanceMinimumReserve) message that the request has been rejected for the reason given. In this case, the business rule code is “E106” with a description of “Invalid Value date”.

Message item	Utilisation
Message Id Document/Rct/MsgHdr/MsgId	NONREF
Identification /Document/Rct/MsgHdr/ReqTp/Prtry/Id	VSTS
Original message Identification /Document/Rct/RctDtIs/OrgnlMsgId/MsgId	Inc998b150-BAHId
Status Code /Document/Rct/RctDtIs/ReqHdlg/StsCd	E106
Description /Document/Rct/RctDtIs/ReqHdlg/Desc	Invalid Value date

Table 172 - Receipt (camt.025) – usage case CLM camt.998 (InsertBalance) fails (Scenario 150)

Usage case example: camt.025_CLM_Receipt_VSTS_bs150.xml

12.2.8 GetReservation (camt.046)

12.2.8.1 Overview and scope of the message

This chapter illustrates the *GetReservation* message.

The *GetReservation* message is sent by a business sender to CLM. It is used to request details of one or more reservation(s) set on CLM MCA(s) on the current business day.

The message can be sent by the following business sender:

- I CLM Account Holder;
- I CB.

The usage of this message is to be found in chapter [Usage of Messages](#) [▶ 324].

In response to the *GetReservation* message, a [ReturnReservation \(camt.047\)](#) [▶ 495] message containing reservation detail(s) or business validation error(s) is returned to the business sender.

12.2.8.2 Schema

Outline of the schema

The *GetReservation* message is composed of the following message building blocks.

MessageHeader

This building block is mandatory and non-repetitive. The identification by the business sender to uniquely and unambiguously identify the message is part of the BAH, therefore the content of message ID is "NONREF".

ReservationQueryDefinition

Definition of the reservation query is optional and non-repetitive and contains SearchCriteria with following elements:

- | account owner;
- | account identification.

References/links

The CLM-specific schema and documentation in XSD/Excel/PDF format as well as the message examples are provided outside of this document under the following link:

http://www.swift.com/mystandards/CLM/camt.046.001.05_CLM

Business rules applicable to the schema

For business rules applicable to *GetReservation* refer to the chapter [Index of validation rules and error codes](#) [▶ 643].

12.2.8.3 The message in business context

Specific message requirements

All content must comply with the business rules for the message.

Message item	Utilisation
Message Header	
Message Identification /Document/GetRsvatn/MsgHdr/MsgId	Value "NONREF" as the message ID is already part of the BAH.

Message item	Utilisation
Reservation Query Definition	
Account Owner's BIC /Document/GetRsvatn/RsvatnQryDef/RsvatnCrit/NewCrit/S chCrit/AcctOwnr/FinInstnId/BICFI	Owner of the account which is being queried.
Account Identification /Document/GetRsvatn/RsvatnQryDef/RsvatnCrit/NewCrit/S chCrit/AcctId/Othr/Id	CLM MCA number is used

Table 173 - GetReservation (camt.046)

Usage case: Query Request Message - Current Reservations Query (Scenario 045)

In this usage example, the business sender has requested information on the current reservations relating to their own CLM Account (ID: "MDEEURCOBADEFFXXXCOBADEFFXXX"):

Message item	Utilisation
Message Identification /Document/GetRsvatn/MsgHdr/MsgId	NONREF
Account Identification /Document/GetRsvatn/RsvatnQryDef/RsvatnCrit/NewCrit/S chCrit/AcctId/Othr/Id	MDEEURCOBADEFFXXXCOBADEFFXXX

Table 174 - GetReservation (camt.046) – usage case Query Request Message - Current Reservations Query (Scenario 045)

Usage case example: camt.046_CLM_CurrentReservationsQuery_bs045.xml

Usage case: Query Request Message - Current Reservations Query (Scenario 046)

In this usage example, the business sender has requested information on the reservations relating to all accounts owned by a party (with BIC: "BSCHARBASSS"):

Message item	Utilisation
Message Identification /Document/GetRsvatn/MsgHdr/Msgld	NONREF
Account Owner´s BIC /Document/GetRsvatn/RsvatnQryDef/RsvatnCrit/NewCrit/S chCrit/AcctOwnr/FinInstnId/BICFI	BSCHARBASSS

Table 175 - GetReservation (camt.046) – usage case Query Request Message - Current Reservations Query (Scenario 046)

Usage case example: camt.046_CLM_CurrentReservationsQuery_bs046.xml

12.2.9 ReturnReservation (camt.047)

12.2.9.1 Overview and scope of the message

This chapter illustrates the *ReturnReservation* message.

The *ReturnReservation* message is sent by CLM in response to a [GetReservation \(camt.046\)](#) [▶ 492] message.

It is used to provide details of one or more reservation(s) set on the requested CLM MCA(s), or information that no reservation is defined, according to the specified search criteria.

The usage of this message is to be found in chapter [Usage of Messages](#) [▶ 324].

In the event of a seizure of funds, the *ReturnReservation* message reports the seized funds under the reservation identification “blocked” (code BLKD).

In the case of business validation error(s) on the [GetReservation](#) [▶ 492] query, CLM sends the *ReturnReservation* message containing the respective error code(s) and error description(s) to the business receiver.

12.2.9.2 Schema

Outline of the schema

The *ReturnReservation* message is composed of the following message building blocks.

MessageHeader

This building block is mandatory and non-repetitive. The identification by the business sender to uniquely and unambiguously identify the message is part of the BAH, therefore the content of message ID is

“NONREF”. The uniquely and unambiguously identifier from the BAH of the [GetReservation](#) [492] message is included in the original business query field.

ReportOrError

This building block is mandatory and non-repetitive. It contains either the information matching the search criteria of the related business query message about reservations in building block BusinessReport or an error indication in OperationalError.

CurrentReservation

This building block is optional but repetitive. It reports one or more current reservations. When it reports the current reservation information, it may contain:

- | reservation type;
- | account owner;
- | account identification;
- | amount and status.

There is no error information given in this block.

References/links

The CLM-specific schema and documentation in XSD/Excel/PDF format as well as the message examples are provided outside of this document under the following link:

http://www.swift.com/mystandards/CLM/camt.047.001.06_CLM

Business rules applicable to the schema

No business rules are applicable to a *ReturnReservation* response message.

12.2.9.3 The message in business context

Specific message contents

Message item	Utilisation
Message Header	
Message Identification /Document/RtrRsvatn/MsgHdr/MsgId	Value "NONREF" as the message ID is already part of the BAH.
Original Business Query Message Identification /Document/RtrRsvatn/MsgHdr/OrgnlBizQry/MsgId	BizMsgIdr copied from the BAH of related GetReservation (camt.046) [492] message

Message item	Utilisation
Business Report	
Current Reservation Type Code /Document/RtrRsvatn/RptOrErr/BizRpt/CurRsvatn/RsvatnId /Tp/Cd	Type of reservation: CARE = Cash reservation, BLKD = Blocked.
Account Owner´s BIC /Document/RtrRsvatn/RptOrErr/BizRpt/CurRsvatn/RsvatnId /AcctOwnr/FinInstnId/BICFI	BIC of CLM Account Holder
Account Identification /Document/RtrRsvatn/RptOrErr/BizRpt/CurRsvatn/RsvatnId /AcctId/Othr/Id	MCA number is used.
Amount /Document/RtrRsvatn/RptOrErr/BizRpt/CurRsvatn/RsvatnO rErr/Rsvatn/Amt/AmtWthCcy	Amount of money of the limit, expressed in an eligible currency.
Status Code /Document/RtrRsvatn/RptOrErr/BizRpt/CurRsvatn/RsvatnO rErr/Rsvatn/Sts/Cd	Statuses 'ENAB' and 'REQD' are reported for current reservations: ENAB = Enabled, REQD = Requested.
Operational Error	
Proprietary /Document/RtrRsvatn/RptOrErr/OprlErr/Err/Prtry	For further detailed information refer to chapter Index of validation rules and error codes [643].
Description /Document/RtrRsvatn/RptOrErr/OprlErr/Desc	Specification of the error, in free format

Table 176 - ReturnReservation (camt.047)

Usage Case: Query Response For Business Data - Current Reservations Query (Scenario 045)

In this usage example, CLM is advising the owner of CLM MCA (ID: "MDEEURCOBADEFFXXXCOBADEFFXXX") of one reservation for EUR 8,575 which is related to CBOs ("CARE"):

Message item	Utilisation
Message Identification /Document/RtrRsvatn/MsgHdr/MsgId	NONREF
Original Business Query Message Identification /Document/RtrRsvatn/MsgHdr/OrgnlBizQry/MsgId	Inc046b045-BAHId
Current Reservation Type Code /Document/RtrRsvatn/RptOrErr/BizRpt/CurRsvatn/RsvatnId /Tp/Cd	CARE
Account Identification /Document/RtrRsvatn/RptOrErr/BizRpt/CurRsvatn/RsvatnId /AcctId/Othr/Id	MDEEURCOBADEFFXXXXCOBADEFFXXXX
Amount /Document/RtrRsvatn/RptOrErr/BizRpt/CurRsvatn/RsvatnO rErr/Rsvatn/Amt/AmtWthCcy	EUR 8575
Status Code /Document/RtrRsvatn/RptOrErr/BizRpt/CurRsvatn/RsvatnO rErr/Rsvatn/Sts/Cd	ENAB

Table 177 - ReturnReservation (camt.047) – usage case Query Response For Business Data - Current Reservations Query (Scenario 045)

Usage case example: camt.047_CLM_CurrentReservationsQueryResponse_Data_bs045.xml

Usage Case: Query Rejection For Failed Business Validation - Current Reservations Query (Scenario 046)

In this usage example, CLM is advising the sender of a previous camt.046 of a problem encountered while trying to fulfil the requested query. In this case, the error code is “D008” indicating that the requested party BIC code does not exist:

Message item	Utilisation
Message Identification /Document/RtrRsvatn/MsgHdr/MsgId	NONREF
Original Business Query Message Identification /Document/RtrRsvatn/MsgHdr/OrgnlBizQry/MsgId	Inc046b046-BAHId
Proprietary /Document/RtrRsvatn/RptOrErr/OprlErr/Err/Prtry	D008
Description /Document/RtrRsvatn/RptOrErr/OprlErr/Desc	Invalid financial or non-financial institution BIC in GetRsvatn/RsvatnQryDef/RsvatnCrit/NewCrit/SchCrit/Acct Ownr/FinInstnId/BICFI

Table 178 - ReturnReservation (camt.047) – usage case Query Rejection For Failed Business Validation - Current Reservations Query (Scenario 046)

Usage case example: camt.047_CLM_CurrentReservationsQueryResponse_Error_bs046.xml

12.2.10 ModifyReservation (camt.048)

12.2.10.1 Overview and scope of the message

This chapter illustrates the *ModifyReservation* message.

The *ModifyReservation* message is sent by a business sender to CLM to modify a current reservation. It is used only to modify a current reservation during the current business day.

The *ModifyReservation* message contains the new value that the CLM Account Holder wants to be applied to the reservation.

The message can be sent by the following business sender:

- I CLM Account Holder;
- I CB on behalf.

The usage of this message is to be found in chapter [Usage of Messages](#) [▶ 324].

This message is also used for the A2A creation and modification of current reservations for seizure of funds.

Standing order reservation configuration in CRDM is not affected by a *ModifyReservation* message sent to CLM.

In response to the *ModifyReservation* message, CLM sends [Receipt \(camt.025\)](#) [▶ 479] messages, to advise the progressive status of the reservation modification.

12.2.10.2 Schema

Outline of the schema

The *ModifyReservation* message is composed of the following message building blocks.

MessageHeader

This building block is mandatory and non-repetitive. The identification by the business sender to uniquely and unambiguously identify the message is part of the BAH, therefore the content of message ID is "NONREF".

ReservationIdentification

Identification of the reservation to be updated.

Current

This building block is mandatory and non-repetitive. It identifies the type of reservation and the account and includes the following elements:

- | type of reservation;
- | account identification.

NewReservationValueSet

This building block is mandatory and non-repetitive. It identifies the amount and date to be executed and includes the following elements:

- | start date (only current business day);
- | amount of reservation with currency.

References/links

The CLM-specific schema and documentation in XSD/Excel/PDF format as well as the message examples are provided outside of this document under the following link:

http://www.swift.com/mystandards/CLM/camt.048.001.05_CLM

Business rules applicable to the schema

For business rules applicable to *ModifyReservation* refer to the chapter [Index of validation rules and error codes](#) [▶ 643].

12.2.10.3 The message in business context

Specific message requirements

All content must comply with the business rules for the message.

Message item	Utilisation
Message Header	
Message Identification /Document/ModifyRsvatn/MsgHdr/MsgId	Value "NONREF" as the message ID is already part of the BAH
ReservationIdentification - Current	
Code /Document/ModifyRsvatn/RsvatnId/Cur/Tp/Cd	Identification of the current reservation. CARE = Cash reservation BLKD = Blocked
Account Identification /Document/ModifyRsvatn/RsvatnId/Cur/AcctId/Othr/Id	MCA number is used
ReservationIdentification – Default not used in CLM	
New Reservation Value Set	
Start Date /Document/ModifyRsvatn/NewRsvatnValSet/StartDtTm/Dt	Date at which the reservation becomes effective.
Amount with Currency /Document/ModifyRsvatn/NewRsvatnValSet/Amt/AmtWthCc y	Amount of money of the limit, expressed in an eligible currency.

Table 179 - ModifyReservation (camt.048)

Usage case: Current Reservation Modification (Scenario 047)

In this usage example, the business sender has requested that the current reservation amount for CBOs (CARE) on its account (ID: "MDEEURCOBADEFFXXXCOBADEFFXXX") is changed from its current value to EUR 10,000 with immediate effect:

Message item	Utilisation
Message Header	
Message Identification /Document/ModifyRsvatn/MsgHdr/MsgId	NONREF
ReservationIdentification - Current	
Code /Document/ModifyRsvatn/RsvatnId/Cur/Tp/Cd	CARE

Message item	Utilisation
Account Identification /Document/ModifyRsvatn/RsvatnId/Cur/AcctId/Othr/Id	MDEEURCOBADEFFXXXCOBADEFFXXX
ReservationIdentification – Default not used in RTGS	
New Reservation Value Set	
Amount with Currency /Document/ModifyRsvatn/NewRsvatnValSet/Amt/AmtWthCc y	EUR 10000

Table 180 - ModifyReservation (camt.048) – usage case Current Reservation Modification (Scenario 047)

Usage case example: camt.048_CLM_ModifyCurrentReservation_bs047.xml

12.2.11 DeleteReservation (camt.049)

12.2.11.1 Overview and scope of the message

This chapter illustrates the *DeleteReservation* message.

The *DeleteReservation* message is sent by a business sender to CLM to delete a current reservation. It is used only to delete the current reservation during the current business day.

The *DeleteReservation* message allows for the deletion of only one reservation.

The message can be sent by the following business sender:

- CLM Account Holder;
- CB on behalf.

The usage of this message is to be found in chapter [Usage of Messages](#) [▶ 324].

This message is also used for the A2A deletion of current reservations for seizure of funds.

Standing order reservation configuration in CRDM is not affected by a *DeleteReservation* message sent to CLM.

In response to the *DeleteReservation* message, CLM sends a [Receipt \(camt.025\)](#) [▶ 479] message to advise on the status of the reservation deletion.

12.2.11.2 Schema

Outline of the schema

The *DeleteReservation* message is composed of the following message building blocks.

MessageHeader

This building block is mandatory and non-repetitive. The identification by the business sender to uniquely and unambiguously identify the message is part of the BAH, therefore the content of message ID is "NONREF".

CurrentReservation

This building block is mandatory and non-repetitive. It identifies the current reservation to delete and includes the following elements:

- | type of reservation;
- | account identification.

References/links

The CLM-specific schema and documentation in XSD/Excel/PDF format as well as the message examples are provided outside of this document under the following link:

http://www.swift.com/mystandards/CLM/camt.049.001.05_CLM

Business rules applicable to the schema

For business rules applicable to *DeleteReservation* refer to the chapter [Index of validation rules and error codes](#) [▶ 643].

12.2.11.3 The message in business context

Specific message requirements

All content must comply with the business rules for the message.

Message item	Utilisation
Message Header	
Message ID Document/DeIRsvatn/MsgHdr/MsgId	Value "NONREF" as the message ID is already part of the BAH

Message item	Utilisation
Current Reservation	
Code	CARE = Cash reservation
/Document/DelRsvatn/CurRsvatn/Tp/Cd	BLKD = Reservation for seizure of funds
Account Identification	CLM Account identification
/Document/DelRsvatn/CurRsvatn/AcctId/Othr/Id	

Table 181 - DeleteReservation (camt.049)

Usage case: Current Reservation Deletion (Scenario 048)

In this usage example, the business sender has requested that the current reservation amount for CBOs from its account (ID: "MDEEURSOLADESTXXXSOLADESTXXX") is deleted with immediate effect:

Message item	Utilisation
Message Id	NONREF
Document/DelRsvatn/MsgHdr/MsgId	
Code	CARE
/Document/DelRsvatn/CurRsvatn/Tp/Cd	
Account Identification	MDEEURSOLADESTXXXSOLADESTXXX
/Document/DelRsvatn/CurRsvatn/AcctId/Othr/Id	

Table 182 - DeleteReservation (camt.049) – usage case Current Reservation Deletion (Scenario 048)

Usage case example: camt.049_CLM_DeleteCurrentReservation_bs048.xml

Usage case: Current Reservation Deletion (Scenario 049)

In this usage example, the business sender has requested that the current reservation amount for CBOs from its account (ID: "MDEEURCOBADEFFXXXCOBADEFFXXX") is deleted with immediate effect:

Message item	Utilisation
Message Id Document/DelRsvatn/MsgHdr/MsgId	NONREF
Code /Document/DelRsvatn/CurRsvatn/Tp/Cd	CARE
Account Identification /Document/DelRsvatn/CurRsvatn/AcctId/Othr/Id	MDEEURCOBADEFFXXXCOBADEFFXXX

Table 183 - DeleteReservation (camt.049) – usage case Current Reservation Deletion (Scenario 049)

Usage case example: camt.049_CLM_DeleteCurrentReservation_bs049.xml

12.2.12 LiquidityCreditTransfer (camt.050)

12.2.12.1 Overview and scope of the message

This chapter illustrates the *LiquidityCreditTransfer* message.

The *LiquidityCreditTransfer* message is sent by a business sender to CLM as business receiver.

The *LiquidityCreditTransfer* can be sent by the following business sender:

- | CLM Account Holder;
- | co-manager;
- | CB.

The *LiquidityCreditTransfer* message is used to request a transfer of funds between two cash accounts in the same (intra-service liquidity transfer order) or in different (inter-service liquidity transfer order) settlement services. Credited and debited accounts must be denominated in the same currency.

The usage of this message is to be found in chapter [Usage of Messages](#) [▶ 324].

In response to the *LiquidityCreditTransfer* message, a [Receipt \(camt.025\)](#) [▶ 479] message containing the status of the liquidity transfer is returned to the business sender.

12.2.12.2 Schema

Outline of the schema

The *LiquidityCreditTransfer* message is composed of the following message building blocks.

MessageHeader

This building block is mandatory and non-repetitive. The identification by the business sender to uniquely and unambiguously identify the message is part of the BAH, therefore the content of message ID is "NONREF".

LiquidityCreditTransfer

This building block is mandatory. It contains detailed information related to the liquidity credit transfer being instructed. It contains the following groups and elements:

- | liquidity transfer identification;
- | creditor and creditor account;
- | transferred amount;
- | debtor and debtor account;
- | settlement date.

References/links

The CLM-specific schema and documentation in XSD/Excel/PDF format as well as the message examples are provided outside of this document under the following link:

http://www.swift.com/mystandards/CLM/camt.050.001.05_CLM

Business rules applicable to the schema

For business rules applicable to *LiquidityCreditTransfer* refer to the chapter [Index of validation rules and error codes](#) [▶ 643].

12.2.12.3 The message in business context

Specific message requirements

All content must comply with the business rules for the message.

Message item	Utilisation
Message Header	
Message Identification Document/LqdyCdtTrf/MsgHdr/MsgId	Value "NONREF" as the message ID is already part of the BAH
Liquidity Credit Transfer	
Instruction Identification /Document/LqdyCdtTrf/LqdyCdtTrf/LqdyTrfId/InstrId	If provided it is ignored by CLM.
End to End Identification	Unique identification assigned by the initiating party to

Message item	Utilisation
/Document/LqdyCdtTrf/LqdyCdtTrf/LqdyTrfId/EndToEndId	unambiguously identify the transaction.
Creditor /Document/LqdyCdtTrf/LqdyCdtTrf/Cdtr/FinInstnId/BICFI	Creditor BIC to be used for Liquidity Transfers to TIPS for reconciliation purposes. In all other cases, if the BIC is present, it will be ignored by CLM.
Creditor Account Identification /Document/LqdyCdtTrf/LqdyCdtTrf/CdtrAcct/Id/Othr/Id	This message element is populated with either a CLM cash account or a cash account in another settlement service.
Creditor Account Type Code /Document/LqdyCdtTrf/LqdyCdtTrf/CdtrAcct/Tp/Cd	These codes are not used in CLM and will be ignored if present.
Transferred Amount Document/LqdyCdtTrf/LqdyCdtTrf/TrfdAmt/AmtWthCcy	Amount to be transferred
Debtor /Document/LqdyCdtTrf/LqdyCdtTrf/Dbtr/FinInstnId/BICFI	Debtor BIC to be used for Liquidity Transfers to TIPS for reconciliation purposes. In all other cases, if the BIC is present, it will be ignored by CLM.
Debtor Account Identification Document/LqdyCdtTrf/LqdyCdtTrf/DbtrAcct/Id/Othr/Id	In CLM, this field must be populated with a CLM cash account.
Debtor Account Type Code /Document/LqdyCdtTrf/LqdyCdtTrf/DbtrAcct/Tp/Cd	These codes are not used in CLM and will be ignored if present.
Settlement Date /Document/LqdyCdtTrf/LqdyCdtTrf/SttlmDt	If used must be the current CLM business date.

Table 184 - LiquidityCreditTransfer (camt.050)

Usage case: Liquidity Credit Transfer Order – MCA To MCA (Scenario 050)

In this usage example, the business sender requires a liquidity movement of EUR 100,000 from one CLM MCA (ID: “MDEEURCOBADEFFXXCOBADEFFXXX”) to another CLM MCA (ID: “MDEEURSOLADESTXXXSOLADESTXXX”):

Message item	Utilisation
Message Header	
Message Identification Document/LqdyCdtTrf/MsgHdr/MsgId	NONREF
Liquidity Credit Transfer	

Message item	Utilisation
End to End Identification /Document/LqdyCdtTrf/LqdyCdtTrf/LqdyTrfId/EndToEndId	Inc050b050-E2EId
Creditor Account Identification /Document/LqdyCdtTrf/LqdyCdtTrf/CdtrAcct/Id/Othr/Id	MDEEURSOLADESTXXXSOLADESTXXX
Transferred Amount Document/LqdyCdtTrf/LqdyCdtTrf/TrfdAmt/AmtWthCcy	EUR 100000
Debtor Account Identification Document/LqdyCdtTrf/LqdyCdtTrf/DbtrAcct/Id/Othr/Id	MDEEURCOBADEFFXXXCOBADEFFXXX

Table 185 - LiquidityCreditTransfer (camt.050) – usage case Liquidity Credit Transfer Order – MCA To MCA (Scenario 050)

Usage case example: camt.050_CLM_LiquidityCreditTransfer_MCAMCA_bs050.xml

Usage case: Liquidity Credit Transfer Order – MCA To DCA (Scenario 051)

A camt.050 moving liquidity from a CLM MCA to an RTGS DCA is submitted to CLM but fails to pass validation

Message item	Utilisation
Message Header	
Message Identification Document/LqdyCdtTrf/MsgHdr/MsgId	NONREF
Liquidity Credit Transfer	
End to End Identification /Document/LqdyCdtTrf/LqdyCdtTrf/LqdyTrfId/EndToEndId	Inc050b051-E2EId
Creditor Account Identification /Document/LqdyCdtTrf/LqdyCdtTrf/CdtrAcct/Id/Othr/Id	RDEEURUBSWCHZHXXXUBSWCHZHXXX
Transferred Amount Document/LqdyCdtTrf/LqdyCdtTrf/TrfdAmt/AmtWthCcy	EUR 300000.00
Debtor Account Identification Document/LqdyCdtTrf/LqdyCdtTrf/DbtrAcct/Id/Othr/Id	MDEEURSOLADESTXXXSOLADESTXXX

Table 186 - LiquidityCreditTransfer (camt.050) – usage case Liquidity Credit Transfer Order – MCA To DCA (Scenario 051)

Usage case example: camt.050_CLM_LiquidityCreditTransfer_MCADCA_bs051.xml

Usage case: Liquidity Credit Transfer Order – MCA To T2S DCA (Scenario 052)

A camt.050 moving liquidity from a CLM MCA to a T2S DCA is submitted to CLM and settles successfully in CLM.

Message item	Utilisation
Message Header	
Message Identification Document/LqdyCdtTrf/MsgHdr/Msgld	NONREF
Liquidity Credit Transfer	
End to End Identification /Document/LqdyCdtTrf/LqdyCdtTrf/LqdyTrfId/EndToEndId	Inc050b052-E2EId
Creditor Account Identification /Document/LqdyCdtTrf/LqdyCdtTrf/CdtrAcct/Id/Othr/Id	ERTGSC0DEEUR001
Transferred Amount Document/LqdyCdtTrf/LqdyCdtTrf/TrfdAmt/AmtWthCcy	EUR 200000
Debtor Account Identification Document/LqdyCdtTrf/LqdyCdtTrf/DbtrAcct/Id/Othr/Id	MDEEURSOLADESTXXXSOLADESTXXX

Table 187 - LiquidityCreditTransfer (camt.050) – usage case Liquidity credit transfer order – MCA to T2S (Scenario 052)

Usage case example: camt.050_CLM_LiquidityCreditTransfer_MCAT2S_bs052.xml

Usage case: Overnight Deposit - Setting Up Order (Scenario 053)

In this usage example, the business sender requires a liquidity movement of EUR 400,000 from its CLM MCA (ID: “MDEEURCOBADEFFXXXCOBADEFFXXX”) to a CLM overnight deposit account (ID: “DDEEURCOBADEFFXXX0001”).

Message item	Utilisation
Message Header	
Message Identification Document/LqdyCdtTrf/MsgHdr/Msgld	NONREF
Liquidity Credit Transfer	

Message item	Utilisation
End to End Identification /Document/LqdyCdtTrf/LqdyCdtTrf/LqdyTrfId/EndToEndId	Inc050b053-E2EId
Creditor Account Identification /Document/LqdyCdtTrf/LqdyCdtTrf/CdtrAcct/Id/Othr/Id	DDEEURCOBADEFFXXX0001
Transferred Amount Document/LqdyCdtTrf/LqdyCdtTrf/TrfdAmt/AmtWthCcy	EUR 400000
Debtor Account Identification Document/LqdyCdtTrf/LqdyCdtTrf/DbtrAcct/Id/Othr/Id	MDEEURCOBADEFFXXXCOBADEFFXXX

Table 188 - LiquidityCreditTransfer (camt.050) – usage case Overnight Deposit - Setting Up Order (Scenario 053)

Usage case example: camt.050_CLM_LiquidityCreditTransfer_OvernightDeposit_bs053.xml

Usage case: Liquidity Credit Transfer Order – MCA To DCA settles (Scenario 070)

In this example, the business sender requires a liquidity movement of EUR252000.00 from a CLM MCA (id: "MDEEURSOLADESTXXXSOLADESTXXX") to an RTGS DCA (id: "RDEEURUBSWCHZHXXXUBSWCHZHXXX"). There is no settlement date indicated but October 7th, 2019 is presumed for the following messages.

Message item	Utilisation
Message ID /Document/LqdyCdtTrf/MsgHdr/MsgId	NONREF
End to End Identification /Document/LqdyCdtTrf/LqdyCdtTrf/LqdyTrfId/EndToEndId	Inc050b070-E2EId
Creditor Account Identification Document/LqdyCdtTrf/LqdyCdtTrf/CdtrAcct/Id/Othr/Id	RDEEURUBSWCHZHXXXUBSWCHZHXXX
Transferred Amount /Document/LqdyCdtTrf/LqdyCdtTrf/TrfdAmt/AmtWthCcy	EUR 252000.00
Debtor Account Identification /Document/LqdyCdtTrf/LqdyCdtTrf/DbtrAcct/Id/Othr/Id	MDEEURSOLADESTXXXSOLADESTXXX

Table 189 - LiquidityCreditTransfer (camt.050) – usage case Liquidity Credit Transfer Order - MCA To DCA settles (Scenario 070)

Usage case example: camt.050_CLM_LiquidityCreditTransfer_MCADCA_bs070.xml

Usage case: Overnight Deposit - Reverse Order

In this usage case, the business sender is instructing CLM to move an amount of liquidity out of a CLM overnight account into another CLM account where the sender requires the liquidity to be.

Usage case example is not available.

Usage case: Refund Of Overnight Deposits

In this usage case, CLM is instructing the movement of the available balance from a CLM overnight account to a CLM MCA owned by the party for which the CLM overnight account was set up.

Usage case example is not available.

Usage case: Marginal Lending On Request – Setting-Up Order

In this usage case, the business sender is instructing CLM to move an amount of liquidity from a CLM CB marginal lending account into a CLM MCA owned by account owner requiring the marginal loan.

Usage case example is not available.

12.2.13 BankToCustomerStatement (camt.053)

12.2.13.1 Overview and scope of the message

This chapter illustrates the *BankToCustomerStatement* message.

CLM creates the *BankToCustomerStatement* message at EoD if specified by the account holder's reporting configuration in CRDM. It is sent to the business receiver either:

- I immediately after creation (also specified in the account holder's report configuration in CRDM);
- I in response to a [ReportQueryRequest \(admi.005\)](#) [▶ 368] message.

One single *BankToCustomerStatement* message reports all settled entries for the closed business day on one single cash account along with the account balance information at EoD.

The *BankToCustomerStatement* message provides information for cash management and/or reconciliation of information on settled entries (fully or partially settled amount). It includes details of underlying cash transfer orders in the entry details.

In case of pagination, [ReceiptAcknowledgement \(admi.007\)](#) [▶ 370] message is used to inform the business sender of the Account statement query about pagination and the respective switch to store-n-forward network service. Additionally the respective response is provided via store-n-forward network service.

The usage of this message is to be found in chapter [Usage of Messages](#) [▶ 324].

The *BankToCustomerStatement* message is also used for [general ledger](#) [▶ 567] reporting to CBs and to the ECB. This is covered in chapter [General ledger \(camt.053\)](#) [▶ 567].

12.2.13.2 Schema

Outline of the schema

The *BankToCustomerStatement* message is composed of the following message building blocks.

GroupHeader

This building block is mandatory and non-repetitive. It must contain an identification assigned by the sending party to uniquely and unambiguously identify the message.

Statement

This building block is mandatory and repetitive. It shows information on posted entries and balances for a CLM MCA. It may contain:

- | creation timestamp;
- | message pagination;
- | statement identification;
- | account identification;
- | account balance/s;
- | summary of transactions;
- | details of each entry: entry reference, amount & currency, debit/credit indicator, status, settlement date, value date, bank transaction code.

References/links

The CLM-specific schema and documentation in XSD/Excel/PDF format as well as the message examples are provided outside of this document under the following link:

http://www.swift.com/mystandards/CLM/camt.053.001.08_CLM

Business rules applicable to the schema

No business rules are applicable to a *BankToCustomerStatement* message.

12.2.13.3 The message in business context

Specific message contents

Message item	Utilisation
Message Identification /Document/BkToCstmrStmt/GrpHdr/MsgId	Value "NONREF" as the message ID is already part of the BAH
Creation Date Time Document/BkToCstmrStmt/GrpHdr/CreDtTm	Date and time at which the message was created
Page Number /Document/BkToCstmrStmt/GrpHdr/MsgPgntn/PgNb	Sequence number of the statement of account message within the set of divided messages recurring to pagination.
Last Page Indicator /Document/BkToCstmrStmt/GrpHdr/MsgPgntn/LastPgInd	Indicator for last statement of account message within the set of divided messages recurring to pagination.
Statement	
Identification Document/BkToCstmrStmt/Stmt/Id	Statement number: At the beginning of the year, the first camt.053 sent for the reported CLM MCA, will be statement number 1.
Account /Document/BkToCstmrStmt/Stmt/Acct/Id/Othr/Id	CLM cash account number can be: <ul style="list-style-type: none"> MCA; CLM dedicated transit account; CLM CB Account; overnight deposit account; marginal lending account; CB ECB Account; ECB mirror account; CLM Technical Account for ECONS II.
Owner /Document/BkToCstmrStmt/Stmt/Acct/Ownr/Id/OrgId/AnyBIC	Party BIC of the CLM Account Holder. For overnight deposit and marginal lending accounts the account owner BIC is the party BIC of the responsible CB.
Two repetitions of balance information	
Balance type /Document/BkToCstmrStmt/Stmt/Bal/Tp/CdOrPrty/Cd	Balance type code of the reported account balance. <ul style="list-style-type: none"> OPBD = Balance at SoD CLBD = Balance at EoD.
Amount /Document/BkToCstmrStmt/Stmt/Bal/Amt	Amount of money of the cash balance.
Credit Debit Indicator	Indicates whether the balance is a credit or a debit. Usage:

Message item	Utilisation
/Document/BkToCstmrStmt/Stmt/Bal/CdtDbtInd	A zero balance is considered to be a credit balance. <ul style="list-style-type: none"> CRDT = Credit balance DBIT = Debit balance
Date /Document/BkToCstmrStmt/Stmt/Bal/Dt/Dt	Date of CLM business day of the reported balance of the CLM cash account.
Transaction Summary	
In the case of message pagination this information is only provided in the first camt.053 and contains all entries on the CLM cash account.	
Total Entries /Document/BkToCstmrStmt/Stmt/TxsSummry/TtINtries/NbOfNtries	Number of individual entries included in the report.
Multiple repetitions of entry	
Entry Reference /Document/BkToCstmrStmt/Stmt/Ntry/NtryRef	CLM booking reference of the settled cash transfer.
Amount /Document/BkToCstmrStmt/Stmt/Ntry/Amt	Settled amount on the CLM cash account.
Credit Debit Indicator /Document/BkToCstmrStmt/Stmt/Ntry/CrdDbtInd	Indicates whether the entry is a credit or a debit. <ul style="list-style-type: none"> CRDT = Operation is an increase DBIT = Operation is a decrease
Status /Document/BkToCstmrStmt/Stmt/Ntry/Sts/Cd	Only entry status "BOOK" is used
Booking Date /Document/BkToCstmrStmt/Stmt/Ntry/BookgDt/DtTm	Time stamp including the calendar date of the settlement of the cash transfer on the CLM cash account.
Value Date /Document/BkToCstmrStmt/Stmt/Ntry/ValDt/Dt	Date of CLM business day of the settlement on the CLM cash account.
Bank Transaction Code /Document/BkToCstmrStmt/Stmt/Ntry/BkTxCd/Prtry/Cd	Proprietary bank transaction code to identify the underlying transaction. <ul style="list-style-type: none"> PMNT = Used for pacs.009 and pacs.010 LIQT = Used for liquidity transfer
Entry Details	
Instruction Identification	Business Message Identifier of the BAH of the underlying

Message item	Utilisation
/Document/BkToCstmrStmt/Stmt/Ntry/NtryDtls/TxDtls/Refs/nstrld	<p>cash transfer message if Instruction Identification is not provided.</p> <p>Business case reference in case of system-generated cash transfers or U2A-generated liquidity transfers.</p> <p>Instruction Identification of the underlying cash transfer message</p>
End To End Identification /Document/BkToCstmrStmt/Stmt/Ntry/NtryDtls/TxDtls/Refs/EndToEndId	<p>end-to-end identification of the settled cash transfer.</p> <p>Standing Order Identification defined by CLM account holder in CRDM is provided for standing order liquidity transfer.</p> <p>Floor/Ceiling Order Identification of the underlying floor/ceiling liquidity transfer defined by the CLM Account Holder in CRDM.</p> <p>The invoice number is used in case of billing direct debit</p> <p>Business case reference in case of other system-generated cash transfers.</p>
UETR /Document/BkToCstmrStmt/Stmt/Ntry/NtryDtls/TxDtls/Refs/UETR	<p>Only provided for payments. Copy of the UETR from the settled payment.</p>
Amount /Document/BkToCstmrStmt/Stmt/Ntry/NtryDtls/TxDtls/Amt	<p>The original instructed amount from:</p> <ul style="list-style-type: none"> the payment order; the liquidity transfer order; the standing order liquidity transfer as recorded in CRDM is provided. <p>In the case of partial execution of liquidity transfer order incl. standing order liquidity transfer, this amount deviates from the settled amount on <Entry> level.</p>
Debtor BIC /Document/BkToCstmrStmt/Stmt/Ntry/NtryDtls/TxDtls/RltdParties/Dbtr/Pty/Id/OrgId/AnyBIC	<p>Provided if debtor BIC is used in the cash transfer order.</p>
Debtor Account /Document/BkToCstmrStmt/Stmt/Ntry/NtryDtls/TxDtls/RltdParties/DbtrAcct/Id/Othr/Id	<p>For liquidity transfer:</p> <ul style="list-style-type: none"> inter-service liquidity transfer: Debtor cash account number in the initiating settlement service; intra-service liquidity transfer: Debtor cash account

Message item	Utilisation
	number in CLM.
Creditor BIC /Document/BkToCstmrStmnt/Stmnt/Ntry/NtryDtls/TxDtls/RltdPties/Cdtr/Pty/Id/OrgId/AnyBIC	Provided if creditor BIC is used in the cash transfer order.
Creditor Account /Document/BkToCstmrStmnt/Stmnt/Ntry/NtryDtls/TxDtls/RltdPties/CdtrAcct/Id/Othr/Id	For liquidity transfer: <ul style="list-style-type: none"> inter-service liquidity transfer: Creditor cash account number in the receiving settlement service; intra-service liquidity transfer: Creditor cash account number in CLM.
Instructing Agent BIC /Document/BkToCstmrStmnt/Stmnt/Ntry/NtryDtls/TxDtls/RltdAgts/InstgAgt/FinInstnId/BICFI	For payment: BIC of the instructing agent
Instructed Agent BIC /Document/BkToCstmrStmnt/Stmnt/Ntry/NtryDtls/TxDtls/RltdAgts/InstdAgt/FinInstnId/BICFI	For payment: BIC of the instructed agent
Local instrument code Document/BkToCstmrStmnt/Stmnt/Ntry/NtryDtls/TxDtls/LclInstm/Cd	Specifies the local instrument, as published in an external local instrument code list.
Local Instrument Proprietary /Document/BkToCstmrStmnt/Stmnt/Ntry/NtryDtls/TxDtls/LclInstm/Prtry	Please find the code list in UDFS section Cash Transfer Category and Business Case Codes for various features [172].

Table 190 - BankToCustomerStatement (camt.053)

Usage case: Statement Of Account (Scenario 999)

A camt.053 Customer statement is produced by CLM at EoD for each account in the system for which the account owner has configured to have a statement produced. The statement message is then sent to appropriate recipients based upon subscription and routing.

In this usage example, the statement is for a CLM Account (ID: "MDEEURSOLADESTXXXSOLADESTXXX") dated 8 October 2019 and includes all examples from all business cases which show as settled on that date. The opening balance shows as zero for convenience but the closing balance is calculated according to the entries listed.

The statement which is retained on CLM is subsequently requested for additional sending via an admi.005 query.

Message item	Utilisation
Group Header Document/BkToCstmrStmnt/GrpHdr/MsgId	NONREF
Creation Date Time Document/BkToCstmrStmnt/GrpHdr/CreDtTm	2019-10-08T18:02:00.001+00:00
Message Pagination – Page Number Document/BkToCstmrStmnt/GrpHdr/MsgPgntn/PgNb	1
Message Pagination – Last Page Indicator Document/BkToCstmrStmnt/GrpHdr/MsgPgntn/LastPgInd	true
Statement	
Identification Document/BkToCstmrStmnt/Stmnt/Id	00001
Account Document/BkToCstmrStmnt/Stmnt/Acct/Id/Othr/Id	MDEEURSOLADESTXXXSOLADESTXXX
Owner /Document/BkToCstmrStmnt/Stmnt/Acct/Ownr/Id/OrgId/AnyBlC	SOLADESTXXX
Multiple repetitions of balance information	
Balance type Document/BkToCstmrStmnt/Stmnt/Bal/Tp/CdOrPrty/Cd	OPBD
Balance amount Document/BkToCstmrStmnt/Stmnt/Bal/Amt	EUR 0
Balance credit/debit Document/BkToCstmrStmnt/Stmnt/Bal/CdtDbtInd	CRDT
Balance date Document/BkToCstmrStmnt/Stmnt/Bal/Dt/Dt	2019-10-08
Balance type Document/BkToCstmrStmnt/Stmnt/Bal/Tp/CdOrPrty/Cd	CLBD
Balance amount Document/BkToCstmrStmnt/Stmnt/Bal/Amt	EUR 100000
Balance credit/debit	CRDT

Message item	Utilisation
Document/BkToCstmrStmt/Stmt/Bal/CdtDbtInd	
Balance date	2019-10-08
Document/BkToCstmrStmt/Stmt/Bal/Dt/Dt	
Transaction Summary	
Total Entries	2
/Document/BkToCstmrStmt/Stmt/TxsSummry/TtlNtries/NbOfNtries	
Multiple repetitions of entry information	
Entry 1	
Entry Reference	CLM-p009b002
Document/BkToCstmrStmt/Stmt/Ntry/NtryRef	
Amount	EUR 0
Document/BkToCstmrStmt/Stmt/Ntry/Amt	
Credit Debit Indicator	CRDT
Document/BkToCstmrStmt/Stmt/Ntry/CrdDbtInd	
Status	BOOK
Document/BkToCstmrStmt/Stmt/Ntry/Sts/Cd	
Booking Date	2019-10-08T09:42:25.001+00:00
Document/BkToCstmrStmt/Stmt/Ntry/BookgDt/DtTm	
Value date	2019-10-08
Document/BkToCstmrStmt/Stmt/Ntry/ValDt/Dt	
Bank transaction code	PMNT
Document/BkToCstmrStmt/Stmt/Ntry/BkTxCd/Prtry/Cd	
Instruction Identification	Inp009b002-InsId
Document/BkToCstmrStmt/Stmt/Ntry/NtryDtls/TxDtls/Refs/InstId	
End to end Identification	Inp009b002-E2EId
Document/BkToCstmrStmt/Stmt/Ntry/NtryDtls/TxDtls/Refs/EndToEndId	
UETR	e009b002-59c5-41e9-be4c-d45102fc201e

Message item	Utilisation
Document/BkToCstmrStmnt/Stmnt/Ntry/NtryDtls/TxDtls/Refs/ UETR	
Debtor BIC /Document/BkToCstmrStmnt/Stmnt/Ntry/NtryDtls/TxDtls/RltdP ties/Dbtr/Pty/Id/Orgld/AnyBIC	MARKDEFFXXX
Creditor BIC /Document/BkToCstmrStmnt/Stmnt/Ntry/NtryDtls/TxDtls/RltdP ties/Cdtr/Pty/Id/Orgld/AnyBIC	SOLADESTXXX
Instructing Agent /Document/BkToCstmrStmnt/Stmnt/Ntry/NtryDtls/TxDtls/RltdA gts/InstgAgt/FinInstnld/BICFI	MARKDEFFXXX
Instructed Agent /Document/BkToCstmrStmnt/Stmnt/Ntry/NtryDtls/TxDtls/RltdA gts/InstdAgt/FinInstnld/BICFI	SOLADESTXXX
Local instrument /Document/BkToCstmrStmnt/Stmnt/Ntry/NtryDtls/TxDtls/LclIns trm/Prtry	CONP
Entry 2	
Entry Reference Document/BkToCstmrStmnt/Stmnt/Ntry/NtryRef	CLM-c050b050
Amount Document/BkToCstmrStmnt/Stmnt/Ntry/Amt	EUR 100000
Credit Debit Indicator Document/BkToCstmrStmnt/Stmnt/Ntry/CrdDbtInd	CRDT
Status Document/BkToCstmrStmnt/Stmnt/Ntry/Sts/Cd	BOOK
Booking Date Document/BkToCstmrStmnt/Stmnt/Ntry/BookgDt/DtTm	2019-10-08T14:19:00.001+00:00
Value date Document/BkToCstmrStmnt/Stmnt/Ntry/ValDt/Dt	2019-10-08
Bank transaction code	LIQT

Message item	Utilisation
Document/BkToCstmrStmnt/Stmnt/Ntry/BkTxCd/Prtry/Cd	
Instruction Identification Document/BkToCstmrStmnt/Stmnt/Ntry/NtryDtls/TxDtls/Refs/InstrId	Inc050b050-BAHId
End To End Identification /Document/BkToCstmrStmnt/Stmnt/Ntry/NtryDtls/TxDtls/Refs/EndToEndId	Inc050b050-E2EId
Debtor Account /Document/BkToCstmrStmnt/Stmnt/Ntry/NtryDtls/TxDtls/RltdParties/DbtrAcct/Id/Othr/Id	MDEEURCOBADEFFXXXXCOBADEFFXXXX
Creditor Account /Document/BkToCstmrStmnt/Stmnt/Ntry/NtryDtls/TxDtls/RltdParties/CdtrAcct/Id/Othr/Id	MDEEURSOLADESTXXXXSOLADESTXXXX
Local Instrument Proprietary /Document/BkToCstmrStmnt/Stmnt/Ntry/NtryDtls/TxDtls/LclInstrm/Prtry	LIIA

Table 191 - BankToCustomerStatement (camt.053) - usage case Statement Of Account (Scenario 999)

Usage case example: camt.053_CLM_BankToCustomerStatement_bs999.xml

12.2.14 BankToCustomerDebitCreditNotification (camt.054)

12.2.14.1 Overview and scope of the message

This chapter illustrates the *BankToCustomerDebitCreditNotification* message.

The *BankToCustomerDebitCreditNotification* message is sent by CLM to a business receiver if specified by the account holder's message subscription in CRDM. It is used to confirm the credit or debit of a certain entry on one of the account holder's CLM cash accounts.

The *BankToCustomerDebitCreditNotification* message is only concerned with one single debit or credit entry on one single CLM cash account.

The usage of this message is to be found in chapter [Usage of Messages](#) [324].

12.2.14.2 Schema

Outline of the schema

The *BankToCustomerDebitCreditNotification* message is composed of the following message building blocks.

GroupHeader

This building block is mandatory and non-repetitive. It contains an identification assigned by the sending party to uniquely and unambiguously identify the message.

Notification

This building block is mandatory and non-repetitive. It notifies of a debit or credit entry for the CLM MCA. It may contain:

- | identification;
- | account identification and account owner;
- | amount;
- | debit/credit indicator;
- | status;
- | booking date;
- | bank transaction code;
- | amount details;
- | further details of the entry: entry references, amount and currency, debit/credit indicator, status, settlement date, bank transaction code.

References/links

The CLM-specific schema and documentation in XSD/Excel/PDF format as well as the message examples are provided outside of this document under the following link:

http://www.swift.com/mystandards/CLM/camt.054.001.08_CLM

Business rules applicable to the schema

No business rules are applicable to a *BankToCustomerDebitCreditNotification* message.

12.2.14.3 The message in business context

Specific message contents

Message item	Utilisation
Group Header	
Message Identification /Document/BkToCstmrDbtCdtNfctn/GrpHdr/MsgId	Value "NONREF" as the message ID is already part of the BAH
Creation Date Time /Document/BkToCstmrDbtCdtNfctn/GrpHdr/CreDtTm	Date and time at which the business payload was created
Notification	
Identification /Document/BkToCstmrDbtCdtNfctn/Nfctn/Id	Copy of Business Message Identifier of BAH of camt.054
Account /Document/BkToCstmrDbtCdtNfctn/Nfctn/Acct/Id/Othr/Id	CLM cash account number can be: <ul style="list-style-type: none"> MCA; CLM CB Account; overnight deposit account; marginal lending account; CB ECB Account; ECB mirror account.
Owner /Document/BkToCstmrDbtCdtNfctn/Nfctn/Acct/Ownr/Id/Or gId/AnyBIC	Party BIC of the CLM cash account holder
Entry	
Entry Reference /Document/BkToCstmrDbtCdtNfctn/Nfctn/Ntry/NtryRef	CLM booking reference of the settled cash transfer or CLM task reference of the executed task (for credit line modification notifications only).
Amount /Document/BkToCstmrDbtCdtNfctn/Nfctn/Ntry/Amt	For cash transfers: Settled amount on the CLM cash account. For credit line modification notification indicated with <LocalInstrument/Proprietary> code "CDLN": The credit line change amount (delta).
Credit Debit Indicator /Document/BkToCstmrDbtCdtNfctn/Nfctn/Ntry/CdtDbtInd	For credit line modification notification, indicated with <LocalInstrument/Proprietary> code "CDLN": <ul style="list-style-type: none"> CRDT = Operation is an increase, DBIT = Operation is a decrease.

Fehler! Verwenden Sie die Registerkarte 'Start', um dem Text zuzuweisen,

Message item	Utilisation
Status /Document/BkToCstmrDbtCdtNfctn/Nfctn/Ntry/Sts/Cd	Only entry status "BOOK" is used
Booking Date /Document/BkToCstmrDbtCdtNfctn/Nfctn/Ntry/BookgDt/DtTm	Time stamp including the calendar date of the settlement of the cash transfer or execution of the credit line modification on the CLM cash account.
Value Date /Document/BkToCstmrDbtCdtNfctn/Nfctn/Ntry/ValDt/Dt	Date of CLM business day of the settlement on the CLM cash account.
Bank Transaction Code /Document/BkToCstmrDbtCdtNfctn/Nfctn/Ntry/BkTxCd/Ptry/Cd	Set of elements used to fully identify the type of underlying transaction resulting in an entry. <ul style="list-style-type: none"> PMNT = Payment LIQT = Liquidity transfer CDLN = Credit line modification
Amount Details Type /Document/BkToCstmrDbtCdtNfctn/Nfctn/Ntry/AmtDtls/PtryAmt/TP	Provides the credit line change amount (delta) of payment types indicated in <LocalInstrument/Proprietary> <ul style="list-style-type: none"> CONP - Connected payment AMLS - Automatic marginal lending - setting up AMLR - Automatic marginal lending - reimbursement
Amount Details Amount /Document/BkToCstmrDbtCdtNfctn/Nfctn/Ntry/AmtDtls/PtryAmt/Amt	The credit line change amount (delta) related to: <ul style="list-style-type: none"> CONP - Connected payment; AMLS - Automatic marginal lending - setting up; AMLR - Automatic marginal lending – reimbursement.
Entry Details	
Instruction Identification /Document/BkToCstmrDbtCdtNfctn/Nfctn/Ntry/NtryDtls/TxDtls/Refs/InstrId	Instruction Identification of the underlying cash transfer message. Business Message Identifier of the BAH of the underlying cash transfer message if Instruction Identification is not provided. Business case reference in case of system-generated cash transfers or U2A-generated liquidity transfers or U2A-generated credit line modifications. Business Message Identifier of the BAH of the underlying camt.998_ModifyCreditLine message.

Message item	Utilisation
<p>End To End Identification</p> <p>/Document/BkToCstmrDbtCdtNfctn/Nfctn/Ntry/NtryDtls/TxDtls/Refs/EndToEndId</p>	<p>end-to-end identification of the underlying cash transfer message.</p> <p>In case of direct debit generated by Billing this is the Invoice Number.</p> <p>Standing Order Identification of the underlying standing order liquidity transfer defined by CLM account holder in CRDM.</p> <p>Floor/Ceiling Order Identification of the underlying floor/ceiling liquidity transfer defined by the CLM Account Holder in CRDM.</p> <p>Business case reference in case of other system-generated cash transfers.</p>
<p>UETR</p> <p>/Document/BkToCstmrDbtCdtNfctn/Nfctn/Ntry/NtryDtls/TxDtls/Refs/UETR</p>	<p>Only provided for payments. Copy of the UETR from the settled payment.</p>
<p>Amount</p> <p>/Document/BkToCstmrDbtCdtNfctn/Nfctn/Ntry/NtryDtls/TxDtls/Amt</p>	<p>The original instructed amount from:</p> <ul style="list-style-type: none"> the payment order; the credit line modification order; the liquidity transfer order; the standing order liquidity transfer as recorded in CRDM is provided. <p>In the case of partial execution of liquidity transfer order incl. standing order liquidity transfer, this amount deviates from the settled amount on <Entry> level.</p>
<p>Debtor BIC</p> <p>/Document/BkToCstmrDbtCdtNfctn/Nfctn/Ntry/NtryDtls/TxDtls/RltdPties/Dbtr/Pty/Id/OrgId/AnyBIC</p>	<p>Provided if the debtor BIC is used in the cash transfer order.</p>
<p>Debtor Account</p> <p>/Document/BkToCstmrDbtCdtNfctn/Nfctn/Ntry/NtryDtls/TxDtls/RltdPties/DbtrAcct/Id/Othr/Id</p>	<p>For liquidity transfer:</p> <ul style="list-style-type: none"> inter-service liquidity transfer: debtor cash account number in the initiating settlement service; intra-service liquidity transfer: debtor cash account number in CLM.
<p>Creditor BIC</p> <p>/Document/BkToCstmrDbtCdtNfctn/Nfctn/Ntry/NtryDtls/TxDtls/Refs/Crdr/BIC</p>	<p>Provided if the creditor BIC is used in the cash transfer order.</p>

Message item	Utilisation
Dtls/RltdPties/Cdtr/Pty/Id/OrgId/AnyBIC	
Creditor Account /Document/BkToCstmrDbtCdtNfctn/Nfctn/Ntry/NtryDtls/Tx Dtls/RltdPties/CdtrAcct/Id/Othr/Id	For liquidity transfer: <ul style="list-style-type: none"> inter-service liquidity transfer: creditor cash account number in the receiving settlement service, intra-service liquidity transfer: creditor cash account number in CLM.
Instructing Agent BIC /Document/BkToCstmrDbtCdtNfctn/Nfctn/Ntry/NtryDtls/Tx Dtls/RltdAgts/InstgAgt/FinInstnId/BICFI	For payment: BIC of the instructing agent
Instructed Agent BIC /Document/BkToCstmrDbtCdtNfctn/Nfctn/Ntry/NtryDtls/Tx Dtls/RltdAgts/InstdAgt/FinInstnId/BICFI	For payment: BIC of the instructed agent
Local instrument code Document/BkToCstmrDbtCdtNfctn/Nfctn/Ntry/NtryDtls/Tx Dtls/LclInstrm/Cd	Specifies the local instrument, as published in an external local instrument code list.
Local Instrument Proprietary /Document/BkToCstmrDbtCdtNfctn/Nfctn/Ntry/NtryDtls/Tx Dtls/LclInstrm/Prtry	Please find the code list in UDFS section Cash Transfer Category and Business Case Codes for various features [172].
Remittance Information Unstructured /Document/BkToCstmrDbtCdtNfctn/Nfctn/Ntry/NtryDtls/Tx Dtls/RmtInf/Ustrd	Copy of <RemittanceInformation/Unstructured> from the payment order.

Table 192 - BankToCustomerDebitCreditNotification (camt.054)

Usage case: Credit Notification (Connected Payment) (Scenario 002)

In this usage example, CLM is advising the owner of a CLM Account (with BIC “SOLADESTXXX”) of a credit of EUR 0 which has been made to that account. The local instrument code of CONP advises that a new credit line has been reduced by EUR 100,000 for the account. The instructing pacs.009 (from the CB) can be identified using the business sender’s references of instruction identification and UETR, which are also supplied on the camt.054.

Message item	Utilisation
Group Header	
Message Identification /Document/BkToCstmrDbtCdtNfctn/GrpHdr/MsgId	NONREF

Message item	Utilisation
Creation Date Time /Document/BkToCstmrDbtCdtNfctn/GrpHdr/CreDtTm	2019-10-08T09:42:30.001+00:00
Notification	
Identification /Document/BkToCstmrDbtCdtNfctn/Nfctn/Id	Ouc054b002-BAHId
Account /Document/BkToCstmrDbtCdtNfctn/Nfctn/Acct/Id/Othr/Id	MDEEURSOLADESTXXXSOLADESTXXX
Account Owner /Document/BkToCstmrDbtCdtNfctn/Nfctn/Acct/Ownr/Id/Or gld/AnyBIC	SOLADESTXXX
Entry Reference /Document/BkToCstmrDbtCdtNfctn/Nfctn/Ntry/NtryRef	CLM-p009b002
Amount /Document/BkToCstmrDbtCdtNfctn/Nfctn/Ntry/Amt	EUR 0
Credit Debit Indicator /Document/BkToCstmrDbtCdtNfctn/Nfctn/Ntry/CdtDbtInd	CRDT
Status /Document/BkToCstmrDbtCdtNfctn/Nfctn/Ntry/Sts/Cd	BOOK
Booking Date /Document/BkToCstmrDbtCdtNfctn/Nfctn/Ntry/BookgDt/Dt Tm	2019-10-08T09:42:25.001+00:00
Value Date /Document/BkToCstmrDbtCdtNfctn/Nfctn/Ntry/ValDt/Dt	2019-10-08
Code /Document/BkToCstmrDbtCdtNfctn/Nfctn/Ntry/BkTxCd/Prt ry/Cd	PMNT
Amount Details Type /Document/BkToCstmrDbtCdtNfctn/Nfctn/Ntry/AmtDtls/Prt ryAmt/Tp	CONP

Fehler! Verwenden Sie die Registerkarte 'Start', um dem Text zuzuweisen,

Message item	Utilisation
Amount Details Amount /Document/BkToCstmrDbtCdtNtfctn/Ntfctn/Ntry/AmtDtls/PtryAmt/Amt	EUR 100000
InstructionIdentification Document/BkToCstmrDbtCdtNtfctn/NtFctn/Ntry/NtryDtls/TxDtls/Refs/InstrId	Inp009b002-InsId
EndToEndIdentification Document/BkToCstmrDbtCdtNtfctn/NtFctn/Ntry/NtryDtls/TxDtls/Refs/EndToEndId	Inp009b002-E2EId
UETR Document/BkToCstmrDbtCdtNtfctn/NtFctn/Ntry/NtryDtls/TxDtls/Refs/UETR	e009b002-59c5-41e9-be4c-d45102fc201e
Amount Document/BkToCstmrDbtCdtNtfctn/NtFctn/Ntry/NtryDtls/TxDtls/Amt	EUR 0
Debtor BIC /Document/BkToCstmrDbtCdtNtfctn/Ntfctn/Ntry/NtryDtls/TxDtls/RltdPties/Dbtr/Pty/Id/OrgId/AnyBIC	MARKDEFFXXX
Creditor BIC /Document/BkToCstmrDbtCdtNtfctn/Ntfctn/Ntry/NtryDtls/TxDtls/RltdPties/Cdtr/Pty/Id/OrgId/AnyBIC	SOLADESTXXX
Instructing Agent BIC /Document/BkToCstmrDbtCdtNtfctn/Ntfctn/Ntry/NtryDtls/TxDtls/RltdAgts/InstgAgt/FinInstnId/BICFI	MARKDEFFXXX
Instructed Agent BIC /Document/BkToCstmrDbtCdtNtfctn/Ntfctn/Ntry/NtryDtls/TxDtls/RltdAgts/InstdAgt/FinInstnId/BICFI	SOLADESTXXX
Local Instrument /Document/BkToCstmrDbtCdtNtfctn/Ntfctn/Ntry/NtryDtls/TxDtls/LclInstrm/Prtry	CONP

Table 193 - BankToCustomerDebitCreditNotification (camt.054) – Credit Notification (Connected Payment) (Scenario 002)

Usage case example: camt.054_CLM_CreditNotification_CONP_bs002.xml

Usage case: Credit Notification (Standard CLM Settlement) (Scenario 004)

In this usage example, CLM is advising the owner of a CLM Account (with ID “MDEEURSOLADESTXXXSOLADESTXXX”) of a credit of EUR 285,000 which has been made to that account, resulting from the settlement of a payment instruction. The instructing pacs.009 (from the CB) can be identified using the business sender’s references of instruction ID and UETR which are also supplied on the camt.054.

Message item	Utilisation
Group Header	
Message Identification /Document/BkToCstmrDbtCdtNfctn/GrpHdr/MsgId	NONREF
Creation Date Time /Document/BkToCstmrDbtCdtNfctn/GrpHdr/CreDtTm	2019-10-09T07:25:01.001+00:00
Notification	
Identification /Document/BkToCstmrDbtCdtNfctn/Nfctn/Id	Ouc054b004-BAHId
Account /Document/BkToCstmrDbtCdtNfctn/Nfctn/Acct/Id/Othr/Id	MDEEURSOLADESTXXXSOLADESTXXX
Account Owner /Document/BkToCstmrDbtCdtNfctn/Nfctn/Acct/Ownr/Id/Or gId/AnyBIC	SOLADESTXXX
Entry Reference /Document/BkToCstmrDbtCdtNfctn/Nfctn/Ntry/NtryRef	CLM-p009b004
Amount /Document/BkToCstmrDbtCdtNfctn/Nfctn/Ntry/Amt	EUR 285000
Credit Debit Indicator /Document/BkToCstmrDbtCdtNfctn/Nfctn/Ntry/CdtDbtInd	CRDT
Status /Document/BkToCstmrDbtCdtNfctn/Nfctn/Ntry/Sts/Cd	BOOK
Booking Date /Document/BkToCstmrDbtCdtNfctn/Nfctn/Ntry/BookgDt/Dt Tm	2019-10-09T07:25:00.001+00:00

Fehler! Verwenden Sie die Registerkarte 'Start', um dem Text zuzuweisen,

Message item	Utilisation
Value Date /Document/BkToCstmrDbtCdtNtfctn/Ntfctn/Ntry/ValDt/Dt	2019-10-09
Code /Document/BkToCstmrDbtCdtNtfctn/Ntfctn/Ntry/BkTxCd/Prt ry/Cd	PMNT
Instruction Identification Document/BkToCstmrDbtCdtNtfctn/NtFctn/Ntry/NtryDtIs/Tx DtIs/Refs/InstrId	Inp009b004-InsId
EndToEndIdentification Document/BkToCstmrDbtCdtNtfctn/NtFctn/Ntry/NtryDtIs/Tx DtIs/Refs/EndToEndId	Inp009b004-E2EId
UETR Document/BkToCstmrDbtCdtNtfctn/NtFctn/Ntry/NtryDtIs/Tx DtIs/Refs/UETR	e009b004-59c5-41e9-be4c-d45102fc201e
Amount Document/BkToCstmrDbtCdtNtfctn/NtFctn/Ntry/NtryDtIs/Tx DtIs/Amt	EUR 285000
Debtor BIC /Document/BkToCstmrDbtCdtNtfctn/Ntfctn/Ntry/NtryDtIs/Tx DtIs/RltdPties/Dbtr/Pty/Id/OrgId/AnyBIC	MARKDEFFXXX
Creditor BIC /Document/BkToCstmrDbtCdtNtfctn/Ntfctn/Ntry/NtryDtIs/Tx DtIs/RltdPties/Cdtr/Pty/Id/OrgId/AnyBIC	SOLADESTXXX
Instructing Agent BIC /Document/BkToCstmrDbtCdtNtfctn/Ntfctn/Ntry/NtryDtIs/Tx DtIs/RltdAgts/InstgAgt/FinInstnId/BICFI	MARKDEFFXXX
Instructed Agent BIC /Document/BkToCstmrDbtCdtNtfctn/Ntfctn/Ntry/NtryDtIs/Tx DtIs/RltdAgts/InstdAgt/FinInstnId/BICFI	SOLADESTXXX

Table 194 - BankToCustomerDebitCreditNotification (camt.054) – usage case Credit Notification (Standard CLM Settlement) (Scenario 004)

Usage case example: camt.054_CLM_CreditNotification_PMNT_bs004.xml

Usage case: Credit Notification (Standard CLM Settlement) (Scenario 050)

In this usage example, CLM is advising the owner of a CLM Account (with ID “MDEEURSOLADESTXXXSOLADESTXXX”) of a credit of EUR 100,000 which has been made to that account, resulting from the settlement of a liquidity transfer order.

Message item	Utilisation
Group Header	
Message Identification /Document/BkToCstmrDbtCdtNfctn/GrpHdr/MsgId	NONREF
Creation Date Time /Document/BkToCstmrDbtCdtNfctn/GrpHdr/CreDtTm	2019-10-08T14:20:00.001+00:00
Notification	
Identification /Document/BkToCstmrDbtCdtNfctn/Nfctn/Id	Ouc054b050-BAHId
Account /Document/BkToCstmrDbtCdtNfctn/Nfctn/Acct/Id/Othr/Id	MDEEURSOLADESTXXXSOLADESTXXX
Account Owner /Document/BkToCstmrDbtCdtNfctn/Nfctn/Acct/Ownr/Id/Or gId/AnyBIC	SOLADESTXXX
Entry Reference /Document/BkToCstmrDbtCdtNfctn/Nfctn/Ntry/NtryRef	CLM-c050b050
Amount /Document/BkToCstmrDbtCdtNfctn/Nfctn/Ntry/Amt	EUR 100000
Credit Debit Indicator /Document/BkToCstmrDbtCdtNfctn/Nfctn/Ntry/CdtDbtInd	CRDT
Status /Document/BkToCstmrDbtCdtNfctn/Nfctn/Ntry/Sts/Cd	BOOK
Booking Date /Document/BkToCstmrDbtCdtNfctn/Nfctn/Ntry/BookgDt/Dt Tm	2019-10-08T14:19:00.001+00:00
Value Date /Document/BkToCstmrDbtCdtNfctn/Nfctn/Ntry/ValDt/Dt	2019-10-08

Message item	Utilisation
Code /Document/BkToCstmrDbtCdtNtfctn/Ntfctn/Ntry/BkTxCd/Ptry/Cd	LIQT
InstructionIdentification Document/BkToCstmrDbtCdtNtfctn/NtFctn/Ntry/NtryDtIs/TxDtIs/Refs/InstrId	Inc050b050-BAHId
EndToEndIdentification Document/BkToCstmrDbtCdtNtfctn/NtFctn/Ntry/NtryDtIs/TxDtIs/Refs/EndToEndId	Inc050b050-E2EId
Amount Document/BkToCstmrDbtCdtNtfctn/NtFctn/Ntry/NtryDtIs/TxDtIs/Amt	EUR 100000
Debtor Account /Document/BkToCstmrDbtCdtNtfctn/NtFctn/Ntry/NtryDtIs/TxDtIs/RltdPties/DbtrAcct/Id/Othr/Id	MDEEURCOBADEFFXXXCOBADEFFXXX
Creditor Account /Document/BkToCstmrDbtCdtNtfctn/NtFctn/Ntry/NtryDtIs/TxDtIs/RltdPties/CdtrAcct/Id/Othr/Id	MDEEURSOLADESTXXXSOLADESTXXX
Local Instrument /Document/BkToCstmrDbtCdtNtfctn/NtFctn/Ntry/NtryDtIs/TxDtIs/LclInstrm/Prtry	LIIA

Table 195 - BankToCustomerDebitCreditNotification (camt.054) – usage case Credit Notification (Standard CLM Settlement) (Scenario 050)

Usage case example: camt.054_CLM_CreditNotification_LIQT_bs050.xml

Usage case: Credit Line Modification Notification (Scenario 064)

In this usage example, CLM is advising the account owner of an MCA (ID: “MDEEURSOLADESTXXXSOLADESTXXX”) that the credit line was increased to EUR 7,500,000 at 09:42:29.001 on 7 October. The initiating camt.998 *ModifyCreditLine* is a replacement flagged with code “RPLC”.

The camt.054 “CDLN” always indicates the change to the credit line value (‘delta’ amount), irrespective of the fact that this business scenario used an absolute replacement credit line value.

Message item	Utilisation
Group Header	
Message Identification /Document/BkToCstmrDbtCdtNfctn/GrpHdr/MsgId	NONREF
Creation Date Time /Document/BkToCstmrDbtCdtNfctn/GrpHdr/CreDtTm	2019-10-07T09:42:30.001+00:00
Notification	
Identification /Document/BkToCstmrDbtCdtNfctn/Nfctn/Id	Ouc054b064-BAHId
Account /Document/BkToCstmrDbtCdtNfctn/Nfctn/Acct/Id/Othr/Id	MDEEURSOLADESTXXXSOLADESTXXX
Account Owner /Document/BkToCstmrDbtCdtNfctn/Nfctn/Acct/Ownr/Id/Or gId/AnyBIC	SOLADESTXXX
Entry Reference /Document/BkToCstmrDbtCdtNfctn/Nfctn/Ntry/NtryRef	TaskRef-c998b064
Amount /Document/BkToCstmrDbtCdtNfctn/Nfctn/Ntry/Amt	EUR 500000
Credit Debit Indicator /Document/BkToCstmrDbtCdtNfctn/Nfctn/Ntry/CdtDbtInd	CRDT
Status /Document/BkToCstmrDbtCdtNfctn/Nfctn/Ntry/Sts/Cd	BOOK
Booking Date /Document/BkToCstmrDbtCdtNfctn/Nfctn/Ntry/BookgDt/Dt Tm	2019-10-07T09:42:29.001+00:00
Value Date /Document/BkToCstmrDbtCdtNfctn/Nfctn/Ntry/ValDt/Dt	2019-10-07
Code /Document/BkToCstmrDbtCdtNfctn/Nfctn/Ntry/BkTxCd/Prt ry/Cd	CDLN

Message item	Utilisation
Instruction Identification /Document/BkToCstmrDbtCdtNfctn/Nfctn/Ntry/NtryDtls/TxDtls/Refs/InstrId	Inc998b064-BAHId
End To End Identification /Document/BkToCstmrDbtCdtNfctn/Nfctn/Ntry/NtryDtls/TxDtls/Refs/EndToEndId	c998b064-BizCase
Amount /Document/BkToCstmrDbtCdtNfctn/Nfctn/Ntry/NtryDtls/TxDtls/Amt	EUR 7500000
Local Instrument /Document/BkToCstmrDbtCdtNfctn/Nfctn/Ntry/NtryDtls/TxDtls/LclInstrm/Prtry	CDLN

Table 196 - BankToCustomerDebitCreditNotification (camt.054) – usage case Credit Line Modification Notification (Scenario 064)

Usage case example: camt.054_CLM_CreditLineModificationNotification_bs064.xml

Usage case: Credit Line Modification Notification (Scenario 065)

In this usage example, CLM is advising the account owner of an MCA (ID: “MDEEURSOLADESTXXXSOLADESTXXX”) that the credit line was increased by EUR 500,000 at 09:42:29.001 on 7 October. The initiating camt.998 *ModifyCreditLine* is a increase flagged with code “INCR”.

The camt.054 always indicates the change to the credit line value (‘delta’ value).

Message item	Utilisation
Group Header	
Message Identification /Document/BkToCstmrDbtCdtNfctn/GrpHdr/MsgId	NONREF
Creation Date Time /Document/BkToCstmrDbtCdtNfctn/GrpHdr/CreDtTm	2019-10-07T09:42:30.001+00:00
Notification	
Identification /Document/BkToCstmrDbtCdtNfctn/Nfctn/Id	Ouc054b065-BAHId

Message item	Utilisation
Account /Document/BkToCstmrDbtCdtNfctn/Nfctn/Acct/Id/Othr/Id	MDEEURSOLADESTXXXSOLADESTXXX
Account Owner /Document/BkToCstmrDbtCdtNfctn/Nfctn/Acct/Ownr/Id/Or gId/AnyBIC	SOLADESTXXX
Entry Reference /Document/BkToCstmrDbtCdtNfctn/Nfctn/Ntry/NtryRef	TaskRef-c998b065
Amount /Document/BkToCstmrDbtCdtNfctn/Nfctn/Ntry/Amt	EUR 500000
Credit Debit Indicator /Document/BkToCstmrDbtCdtNfctn/Nfctn/Ntry/CdtDbtInd	CRDT
Status /Document/BkToCstmrDbtCdtNfctn/Nfctn/Ntry/Sts/Cd	BOOK
Booking Date /Document/BkToCstmrDbtCdtNfctn/Nfctn/Ntry/BookgDt/Dt Tm	2019-10-07T09:42:29.001+00:00
Value Date /Document/BkToCstmrDbtCdtNfctn/Nfctn/Ntry/ValDt/Dt	2019-10-07
Code /Document/BkToCstmrDbtCdtNfctn/Nfctn/Ntry/BkTxCd/Prt ry/Cd	CDLN
Instruction Identification /Document/BkToCstmrDbtCdtNfctn/Nfctn/Ntry/NtryDtIs/Tx DtIs/Refs/InstrId	Inc998b065-BAHId

Message item	Utilisation
End To End Identification /Document/BkToCstmrDbtCdtNfctn/Nfctn/Ntry/NtryDtls/TxDtls/Refs/EndToEndId	c998b065-BizCase
Amount /Document/BkToCstmrDbtCdtNfctn/Nfctn/Ntry/NtryDtls/TxDtls/Amt	EUR 500000
Local Instrument /Document/BkToCstmrDbtCdtNfctn/Nfctn/Ntry/NtryDtls/TxDtls/LclInstrm/Prtry	CDLN

Table 197 - BankToCustomerDebitCreditNotification (camt.054) – usage case Credit Line Modification Notification (Scenario 065)

Usage case example: camt.054_CLM_CreditLineModificationNotification_bs065.xml

Usage case: Debit Notification (Standard CLM Settlement) (Scenario 068)

In this usage example, CLM is advising the owner of a CLM Account (with ID “MDEEURCOBADEFFXXXCOBADEFFXXX”) of a debit of EUR 18,500 which has been taken from that account, resulting from the settlement of a Billing direct debit order. The Credit of this invoiced amount is at the CB “MARKDEFFXXX”.

Message item	Utilisation
Group Header	
Message Identification /Document/BkToCstmrDbtCdtNfctn/GrpHdr/MsgId	NONREF
Creation Date Time /Document/BkToCstmrDbtCdtNfctn/GrpHdr/CreDtTm	2019-10-07T14:20:00.001+00:00
Notification	
Identification /Document/BkToCstmrDbtCdtNfctn/Nfctn/Id	Ouc054b068-BAHId
Account /Document/BkToCstmrDbtCdtNfctn/Nfctn/Acct/Id/Othr/Id	MDEEURCOBADEFFXXXCOBADEFFXXX
Account Owner /Document/BkToCstmrDbtCdtNfctn/Nfctn/Acct/Ownr/Id/OrigId/AnyBIC	COBADEFFXXX

Message item	Utilisation
Entry Reference /Document/BkToCstmrDbtCdtNfctn/Nfctn/Ntry/NtryRef	CLM-e010b068
Amount /Document/BkToCstmrDbtCdtNfctn/Nfctn/Ntry/Amt	EUR 18500
Credit Debit Indicator /Document/BkToCstmrDbtCdtNfctn/Nfctn/Ntry/CdtDbtInd	DBIT
Status /Document/BkToCstmrDbtCdtNfctn/Nfctn/Ntry/Sts/Cd	BOOK
Booking Date /Document/BkToCstmrDbtCdtNfctn/Nfctn/Ntry/BookgDt/Dt Tm	2019-10-07T14:19:00.001+00:00
Value Date /Document/BkToCstmrDbtCdtNfctn/Nfctn/Ntry/ValDt/Dt	2019-10-07
Code /Document/BkToCstmrDbtCdtNfctn/Nfctn/Ntry/BkTxCd/Prt ry/Cd	PMNT
Instruction Identification /Document/BkToCstmrDbtCdtNfctn/Nfctn/Ntry/NtryDtls/Tx Dtls/Refs/InstrId	Ine010b068-BizCase
End To End ID Document/BkToCstmrDbtCdtNfctn/Nfctn/Ntry/NtryDtls/Tx Dtls/Refs/EndToEndId	Ine010b068-InvoiceId
Amount Document/BkToCstmrDbtCdtNfctn/Nfctn/Ntry/NtryDtls/Tx Dtls/Amt	EUR 18500
Debtor BIC /Document/BkToCstmrDbtCdtNfctn/Nfctn/Ntry/NtryDtls/Tx Dtls/RltdPties/Dbtr/Pty/Id/OrgId/AnyBIC	COBADEFFXXX
Creditor BIC	MARKDEFFXXX

Message item	Utilisation
/Document/BkToCstmrDbtCdtNfctn/Nfctn/Ntry/NtryDtls/TxDtls/RltdPties/Cdtr/Pty/Id/OrgId/AnyBIC	
Instructing Agent BIC /Document/BkToCstmrDbtCdtNfctn/Nfctn/Ntry/NtryDtls/TxDtls/RltdAgts/InstgAgt/FinInstnId/BICFI	MARKDEFFXXX
Instructed Agent BIC /Document/BkToCstmrDbtCdtNfctn/Nfctn/Ntry/NtryDtls/TxDtls/RltdAgts/InstdAgt/FinInstnId/BICFI	COBADEFFXXX
Local Instrument /Document/BkToCstmrDbtCdtNfctn/Nfctn/Ntry/NtryDtls/TxDtls/LclInstrm/Prtry	BILI

Table 198 - BankToCustomerDebitCreditNotification (camt.054) – usage case Debit Notification (Standard CLM Settlement) (Scenario 068)

Usage case example: camt.054_CLM_DebitNotification_Billing_bs068.xml

Usage case: Automatic Marginal Lending (AMLS) (Scenario 073)

In this example, CLM is advising the owner of a CLM account (Id “MDEEURCOBADEFFXXXCOBADEFFXXX”) of a credit of EUR117000 which has been made to that account. The AmountDetails block advises that the credit line has also been reduced by EUR117000 for the account.

Message item	Utilisation
Group Header	
Message Identification /Document/BkToCstmrDbtCdtNfctn/GrpHdr/MsgId	NONREF
Creation Date Time /Document/BkToCstmrDbtCdtNfctn/GrpHdr/CreDtTm	2019-10-07T18:39:02.000+00:00
Notification	
Identification /Document/BkToCstmrDbtCdtNfctn/Nfctn/Id	Ouc054b073CS-BAHId
Account /Document/BkToCstmrDbtCdtNfctn/Nfctn/Acct/Id/Othr/Id	MDEEURCOBADEFFXXXCOBADEFFXXX
Account Owner	COBADEFFXXX

Message item	Utilisation
/Document/BkToCstmrDbtCdtNfctn/Nfctn/Acct/Ownr/Id/Or gld/AnyBIC	
Entry Reference /Document/BkToCstmrDbtCdtNfctn/Nfctn/Ntry/NtryRef	CLM-AMLSb073
Amount /Document/BkToCstmrDbtCdtNfctn/Nfctn/Ntry/Amt	EUR 117000.00
Credit Debit Indicator /Document/BkToCstmrDbtCdtNfctn/Nfctn/Ntry/CdtDbtInd	CRDT
Status /Document/BkToCstmrDbtCdtNfctn/Nfctn/Ntry/Sts/Cd	BOOK
Booking Date /Document/BkToCstmrDbtCdtNfctn/Nfctn/Ntry/BookgDt/Dt Tm	2019-10-07T18:39:01.000+00:00
Value Date /Document/BkToCstmrDbtCdtNfctn/Nfctn/Ntry/ValDt/Dt	2019-10-07
Code /Document/BkToCstmrDbtCdtNfctn/Nfctn/Ntry/BkTxCd/Prt ry/Cd	PMNT
Amount Details Type /Document/BkToCstmrDbtCdtNfctn/Nfctn/Ntry/AmtDtls/Prt ryAmt/Tp	AMLS
Amount Details Amount /Document/BkToCstmrDbtCdtNfctn/Nfctn/Ntry/AmtDtls/Prt ryAmt/Amt	EUR 117000.00
Instruction ID /Document/BkToCstmrDbtCdtNfctn/Nfctn/Ntry/NtryDtls/Tx Dtls/Refs/InstrId	EDAMLSb073-BizTranId
End To End ID /Document/BkToCstmrDbtCdtNfctn/Nfctn/Ntry/NtryDtls/Tx Dtls/Refs/EndToEndId	EDAMLSb073-BizTranId
Transaction Amount	EUR 117000.00

Message item	Utilisation
/Document/BkToCstmrDbtCdtNfctn/Nfctn/Ntry/NtryDtls/TxDtls/Amt	
Related Parties Debtor BIC BkToCstmrDbtCdtNfctn/Nfctn/Ntry/NtryDtls/TxDtls/RltdPties/Dbtr/Pty/Id/OrgId/AnyBIC	MARKDEFFXXX
Related Parties Creditor BIC BkToCstmrDbtCdtNfctn/Nfctn/Ntry/NtryDtls/TxDtls/RltdPties/Cdtr/Pty/Id/OrgId/AnyBIC	COBADEFFXXX
Related Agents Instructing Agent BIC BkToCstmrDbtCdtNfctn/Nfctn/Ntry/NtryDtls/TxDtls/RltdAgts/InstgAgt/FinInstnId/BICFI	MARKDEFFXXX
Related Agents Instructed Agent BIC BkToCstmrDbtCdtNfctn/Nfctn/Ntry/NtryDtls/TxDtls/RltdAgts/InstdAgt/FinInstnId/BICFI	COBADEFFXXX
Local Instrument /Document/BkToCstmrDbtCdtNfctn/Nfctn/Ntry/NtryDtls/TxDtls/LclInstrm/Prtry	AMLS

Table 199 - BankToCustomerDebitCreditNotification (camt.054) – usage case automatic marginal lending (AMLS to account holder) (Scenario 073)

Usage case example: camt.054_CLM_CreditNotification_AMLS_bs073.xml

In this example, CLM is advising the CB owner of a marginal lending account (Id “LDEEURCOBADEFFXXX0001”) of a debit of EUR117000 which has been made to that account.

Message item	Utilisation
Group Header	
Message Identification /Document/BkToCstmrDbtCdtNfctn/GrpHdr/MsgId	NONREF
Creation Date Time /Document/BkToCstmrDbtCdtNfctn/GrpHdr/CreDtTm	2019-10-07T18:39:02.000+00:00
Notification	
Identification /Document/BkToCstmrDbtCdtNfctn/Nfctn/Id	Ouc054b073DS-BAHId

Message item	Utilisation
Account /Document/BkToCstmrDbtCdtNfctn/Nfctn/Acct/Id/Othr/Id	LDEEURCOBADEFFXXX0001
Account Owner /Document/BkToCstmrDbtCdtNfctn/Nfctn/Acct/Ownr/Id/Or gId/AnyBIC	MARKDEFFXXX
Entry Reference /Document/BkToCstmrDbtCdtNfctn/Nfctn/Ntry/NtryRef	CLM-AMLSb073
Amount /Document/BkToCstmrDbtCdtNfctn/Nfctn/Ntry/Amt	EUR 117000.00
Credit Debit Indicator /Document/BkToCstmrDbtCdtNfctn/Nfctn/Ntry/CdtDbtInd	DBIT
Status /Document/BkToCstmrDbtCdtNfctn/Nfctn/Ntry/Sts/Cd	BOOK
Booking Date /Document/BkToCstmrDbtCdtNfctn/Nfctn/Ntry/BookgDt/Dt Tm	2019-10-07T18:39:01.000+00:00
Value Date /Document/BkToCstmrDbtCdtNfctn/Nfctn/Ntry/ValDt/Dt	2019-10-07
Code /Document/BkToCstmrDbtCdtNfctn/Nfctn/Ntry/BkTxCd/Prt ry/Cd	PMNT
Instruction ID /Document/BkToCstmrDbtCdtNfctn/Nfctn/Ntry/NtryDtIs/Tx DtIs/Refs/InstrId	EDAMLSb073-BizTranId
End To End ID /Document/BkToCstmrDbtCdtNfctn/Nfctn/Ntry/NtryDtIs/Tx DtIs/Refs/EndToEndId	EDAMLSb073-BizTranId
Transaction Amount /Document/BkToCstmrDbtCdtNfctn/Nfctn/Ntry/NtryDtIs/Tx DtIs/Amt	EUR 117000.00
Related Parties Debtor BIC	MARKDEFFXXX

Message item	Utilisation
BkToCstmrDbtCdtNtfctn/Ntfctn/Ntry/NtryDtls/TxDtls/RltdPtie s/Dbtr/Pty/Id/OrgId/AnyBIC	
Related Parties Creditor BIC	COBADEFFXXX
BkToCstmrDbtCdtNtfctn/Ntfctn/Ntry/NtryDtls/TxDtls/RltdPtie s/Cdtr/Pty/Id/OrgId/AnyBIC	
Related Agents Instructing Agent BIC	MARKDEFFXXX
BkToCstmrDbtCdtNtfctn/Ntfctn/Ntry/NtryDtls/TxDtls/RltdAgt s/InstgAgt/FinInstnId/BICFI	
Related Agents Instructed Agent BIC	COBADEFFXXX
BkToCstmrDbtCdtNtfctn/Ntfctn/Ntry/NtryDtls/TxDtls/RltdAgt s/InstdAgt/FinInstnId/BICFI	
Local Instrument	AMLS
/Document/BkToCstmrDbtCdtNtfctn/Ntfctn/Ntry/NtryDtls/Tx Dtls/LclInstrm/Prtry	

Table 200 - BankToCustomerDebitCreditNotification (camt.054) – usage case automatic marginal lending (AMLS to CB) (Scenario 073)

Usage case example: camt.054_CLM_DebitNotification_AMLS_bs073.xml

Usage case: Automatic Marginal Lending (AMLR) (Scenario 073)

In this example, CLM is advising the owner of a CLM account (Id “MDEEURCOBADEFFXXXCOBADEFFXXX”) of a debit of EUR117000, which has been taken from that account. The AmountDetails block advises that the credit line has also been increased by EUR117000 for the account.

Message item	Utilisation
Group Header	
Message Identification	NONREF
/Document/BkToCstmrDbtCdtNtfctn/GrpHdr/MsgId	2019-10-07T19:15:02.000+00:00
Notification	
Identification	Ouc054b073DR-BAHId
/Document/BkToCstmrDbtCdtNtfctn/Ntfctn/Id	
Account	MDEEURCOBADEFFXXXCOBADEFFXXX
/Document/BkToCstmrDbtCdtNtfctn/Ntfctn/Acct/Id/Othr/Id	

Message item	Utilisation
Account Owner /Document/BkToCstmrDbtCdtNfctn/Nfctn/Acct/Ownr/Id/Or gId/AnyBIC	COBADEFFXXX
Entry Reference /Document/BkToCstmrDbtCdtNfctn/Nfctn/Ntry/NtryRef	CLM-AMLRb073
Amount /Document/BkToCstmrDbtCdtNfctn/Nfctn/Ntry/Amt	EUR 117000.00
Credit Debit Indicator /Document/BkToCstmrDbtCdtNfctn/Nfctn/Ntry/CdtDbtInd	DBIT
Status /Document/BkToCstmrDbtCdtNfctn/Nfctn/Ntry/Sts/Cd	BOOK
Booking Date /Document/BkToCstmrDbtCdtNfctn/Nfctn/Ntry/BookgDt/Dt Tm	2019-10-07T19:15:01.000+00:00
Value Date /Document/BkToCstmrDbtCdtNfctn/Nfctn/Ntry/ValDt/Dt	2019-10-08
Code /Document/BkToCstmrDbtCdtNfctn/Nfctn/Ntry/BkTxCd/Prt ry/Cd	PMNT
Amount Details Type /Document/BkToCstmrDbtCdtNfctn/Nfctn/Ntry/AmtDtls/Prt ryAmt/Tp	AMLR
Amount Details Amount /Document/BkToCstmrDbtCdtNfctn/Nfctn/Ntry/AmtDtls/Prt ryAmt/Amt	EUR 117000.00
Instruction ID /Document/BkToCstmrDbtCdtNfctn/Nfctn/Ntry/NtryDtls/Tx Dtls/Refs/InstrId	SDAMLRb073-BizTranId
End To End ID /Document/BkToCstmrDbtCdtNfctn/Nfctn/Ntry/NtryDtls/Tx Dtls/Refs/EndToEndId	SDAMLRb073-BizTranId

Message item	Utilisation
Transaction Amount /Document/BkToCstmrDbtCdtNfctn/Nfctn/Ntry/NtryDtls/TxDtls/Amt	EUR 117000.00
Related Parties Debtor BIC BkToCstmrDbtCdtNfctn/Nfctn/Ntry/NtryDtls/TxDtls/RltdPties/Dbtr/Pty/Id/OrgId/AnyBIC	COBADEFFXXX
Related Parties Creditor BIC BkToCstmrDbtCdtNfctn/Nfctn/Ntry/NtryDtls/TxDtls/RltdPties/Cdtr/Pty/Id/OrgId/AnyBIC	MARKDEFFXXX
Related Agents Instructing Agent BIC BkToCstmrDbtCdtNfctn/Nfctn/Ntry/NtryDtls/TxDtls/RltdAgts/InstgAgt/FinInstnId/BICFI	COBADEFFXXX
Related Agents Instructed Agent BIC BkToCstmrDbtCdtNfctn/Nfctn/Ntry/NtryDtls/TxDtls/RltdAgts/InstdAgt/FinInstnId/BICFI	MARKDEFFXXX
Local Instrument /Document/BkToCstmrDbtCdtNfctn/Nfctn/Ntry/NtryDtls/TxDtls/LclInstrm/Prtry	AMLR

Table 201 - BankToCustomerDebitCreditNotification (camt.054) – usage case automatic marginal lending (AMLR to account holder) (Scenario 073)

Usage case example: camt.054_CLM_DebitNotification_AMLR_bs073.xml

In this example, CLM is advising the CB owner of a marginal lending account (Id “LDEEURCOBADEFFXXX0001”) of a credit of EUR117000 which has been made to that account.

Message item	Utilisation
Group Header	
Message Identification /Document/BkToCstmrDbtCdtNfctn/GrpHdr/MsgId	NONREF
Creation Date Time /Document/BkToCstmrDbtCdtNfctn/GrpHdr/CreDtTm	2019-10-07T19:15:02.000+00:00
Notification	
Identification	Ouc054b073CR-BAHId

Message item	Utilisation
/Document/BkToCstmrDbtCdtNfctn/Nfctn/Id	
Account	LDEEURCOBADEFFXXX0001
/Document/BkToCstmrDbtCdtNfctn/Nfctn/Acct/Id/Othr/Id	
Account Owner	MARKDEFFXXX
/Document/BkToCstmrDbtCdtNfctn/Nfctn/Acct/Ownr/Id/Or gId/AnyBIC	
Entry Reference	CLM-AMLRb073
/Document/BkToCstmrDbtCdtNfctn/Nfctn/Ntry/NtryRef	
Amount	EUR 117000.00
/Document/BkToCstmrDbtCdtNfctn/Nfctn/Ntry/Amt	
Credit Debit Indicator	CRDT
/Document/BkToCstmrDbtCdtNfctn/Nfctn/Ntry/CdtDbtInd	
Status	BOOK
/Document/BkToCstmrDbtCdtNfctn/Nfctn/Ntry/Sts/Cd	
Booking Date	2019-10-07T19:15:01.000+00:00
/Document/BkToCstmrDbtCdtNfctn/Nfctn/Ntry/BookgDt/Dt Tm	
Value Date	2019-10-08
/Document/BkToCstmrDbtCdtNfctn/Nfctn/Ntry/ValDt/Dt	
Code	PMNT
/Document/BkToCstmrDbtCdtNfctn/Nfctn/Ntry/BkTxCd/Prt ry/Cd	
Instruction ID	SDAMLRb073-BizTranId
/Document/BkToCstmrDbtCdtNfctn/Nfctn/Ntry/NtryDtIs/Tx DtIs/Refs/InstrId	
End To End ID	SDAMLRb073-BizTranId
/Document/BkToCstmrDbtCdtNfctn/Nfctn/Ntry/NtryDtIs/Tx DtIs/Refs/EndToEndId	
Transaction Amount	EUR 117000.00
/Document/BkToCstmrDbtCdtNfctn/Nfctn/Ntry/NtryDtIs/Tx DtIs/Amt	

Message item	Utilisation
Related Parties Debtor BIC BkToCstmrDbtCdtNfctn/Nfctn/Ntry/NtryDtls/TxDtls/RltdPtie s/Dbtr/Pty/Id/OrgId/AnyBIC	COBADEFFXXX
Related Parties Creditor BIC BkToCstmrDbtCdtNfctn/Nfctn/Ntry/NtryDtls/TxDtls/RltdPtie s/Cdtr/Pty/Id/OrgId/AnyBIC	MARKDEFFXXX
Related Agents Instructing Agent BIC BkToCstmrDbtCdtNfctn/Nfctn/Ntry/NtryDtls/TxDtls/RltdAgt s/InstgAgt/FinInstnId/BICFI	COBADEFFXXX
Related Agents Instructed Agent BIC BkToCstmrDbtCdtNfctn/Nfctn/Ntry/NtryDtls/TxDtls/RltdAgt s/InstdAgt/FinInstnId/BICFI	MARKDEFFXXX
Local Instrument /Document/BkToCstmrDbtCdtNfctn/Nfctn/Ntry/NtryDtls/Tx Dtls/LclInstrm/Prtry	AMLR

Table 202 - BankToCustomerDebitCreditNotification (camt.054) – usage case automatic marginal lending (AMLR to CB) (Scenario 073)

Usage case example: camt.054_CLM_CreditNotification_AMLR_bs073.xml

Usage case: Automatic Marginal Lending (MLIN) (Scenario 073)

In this example, CLM is advising the PB owner of an interest amount debited from their default MCA, in respect of interest due from marginal lending.

Message item	Utilisation
Group Header	
Message Identification /Document/BkToCstmrDbtCdtNfctn/GrpHdr/MsgId	NONREF
Creation Date Time /Document/BkToCstmrDbtCdtNfctn/GrpHdr/CreDtTm	2019-10-08T16:00:01.000+00:00
Notification	
Identification /Document/BkToCstmrDbtCdtNfctn/Nfctn/Id	Ouc054b073DI-BAHId
Account	MDEEURCOBADEFFXXXCOBADEFFXXX

Message item	Utilisation
/Document/BkToCstmrDbtCdtNfctn/Nfctn/Acct/Id/Othr/Id	
Account Owner	COBADEFFXXX
/Document/BkToCstmrDbtCdtNfctn/Nfctn/Acct/Ownr/Id/Or gld/AnyBIC	
Entry Reference	CLM-MLINb073
/Document/BkToCstmrDbtCdtNfctn/Nfctn/Ntry/NtryRef	
Amount	EUR 117.00
/Document/BkToCstmrDbtCdtNfctn/Nfctn/Ntry/Amt	
Credit Debit Indicator	DBIT
/Document/BkToCstmrDbtCdtNfctn/Nfctn/Ntry/CdtDbtInd	
Status	BOOK
/Document/BkToCstmrDbtCdtNfctn/Nfctn/Ntry/Sts/Cd	
Booking Date	2019-10-08T16:00:00.000+00:00
/Document/BkToCstmrDbtCdtNfctn/Nfctn/Ntry/BookgDt/Dt Tm	
Value Date	2019-10-08
/Document/BkToCstmrDbtCdtNfctn/Nfctn/Ntry/ValDt/Dt	
Code	PMNT
/Document/BkToCstmrDbtCdtNfctn/Nfctn/Ntry/BkTxCd/Prtr y/Cd	
Instruction ID	EDMLINb073-BizTranId
/Document/BkToCstmrDbtCdtNfctn/Nfctn/Ntry/NtryDtIs/Tx DtIs/Refs/InstrId	
End To End ID	EDMLINb073-BizTranId
/Document/BkToCstmrDbtCdtNfctn/Nfctn/Ntry/NtryDtIs/Tx DtIs/Refs/EndToEndId	
Transaction Amount	EUR 117.00
/Document/BkToCstmrDbtCdtNfctn/Nfctn/Ntry/NtryDtIs/Tx DtIs/Amt	
Related Parties Debtor BIC	COBADEFFXXX
BkToCstmrDbtCdtNfctn/Nfctn/Ntry/NtryDtIs/TxDtIs/RltdPtie	

Message item	Utilisation
s/Dbtr/Pty/Id/OrgId/AnyBIC	
Related Parties Creditor BIC BkToCstmrDbtCdtNfctn/Nfctn/Ntry/NtryDtIs/TxDtIs/RltdPtie s/Cdtr/Pty/Id/OrgId/AnyBIC	MARKDEFFXXX
Related Agents Instructing Agent BIC BkToCstmrDbtCdtNfctn/Nfctn/Ntry/NtryDtIs/TxDtIs/RltdAgt s/InstgAgt/FinInstnId/BICFI	COBADEFFXXX
Related Agents Instructed Agent BIC BkToCstmrDbtCdtNfctn/Nfctn/Ntry/NtryDtIs/TxDtIs/RltdAgt s/InstdAgt/FinInstnId/BICFI	MARKDEFFXXX
Local Instrument /Document/BkToCstmrDbtCdtNfctn/Nfctn/Ntry/NtryDtIs/Tx DtIs/LclInstnm/Prtry	MLIN

Table 203 - BankToCustomerDebitCreditNotification (camt.054) – usage case automatic marginal lending (MLIN to account holder) (Scenario 073)

Usage case example: camt.054_CLM_DebitNotification_MLIN_bs073.xml

In this example, CLM is advising the CB owner of an interest amount credited to their marginal lending account for a particular PB, in respect of interest due from marginal lending.

Message item	Utilisation
Group Header	
Message Identification /Document/BkToCstmrDbtCdtNfctn/GrpHdr/MsgId	NONREF
Creation Date Time /Document/BkToCstmrDbtCdtNfctn/GrpHdr/CreDtTm	2019-10-08T16:00:01.000+00:00
Notification	
Identification /Document/BkToCstmrDbtCdtNfctn/Nfctn/Id	Ouc054b073CI-BAHId
Account /Document/BkToCstmrDbtCdtNfctn/Nfctn/Acct/Id/Othr/Id	MDEEURMARKDEFFXXXMARKDEFFXXX
Account Owner /Document/BkToCstmrDbtCdtNfctn/Nfctn/Acct/Ownr/Id/Or	MARKDEFFXXX

Message item	Utilisation
gld/AnyBIC	
Entry Reference /Document/BkToCstmrDbtCdtNfctn/Nfctn/Ntry/NtryRef	CLM-MLINb073
Amount /Document/BkToCstmrDbtCdtNfctn/Nfctn/Ntry/Amt	EUR 117.00
Credit Debit Indicator /Document/BkToCstmrDbtCdtNfctn/Nfctn/Ntry/CdtDbtInd	CRDT
Status /Document/BkToCstmrDbtCdtNfctn/Nfctn/Ntry/Sts/Cd	BOOK
Booking Date /Document/BkToCstmrDbtCdtNfctn/Nfctn/Ntry/BookgDt/DtTm	2019-10-08T16:00:00.000+00:00
Value Date /Document/BkToCstmrDbtCdtNfctn/Nfctn/Ntry/ValDt/Dt	2019-10-08
Code /Document/BkToCstmrDbtCdtNfctn/Nfctn/Ntry/BkTxCd/Ptry/Cd	PMNT
Instruction ID /Document/BkToCstmrDbtCdtNfctn/Nfctn/Ntry/NtryDtIs/TxDtIs/Refs/InstrId	EDMLINb073-BizTranId
End To End ID /Document/BkToCstmrDbtCdtNfctn/Nfctn/Ntry/NtryDtIs/TxDtIs/Refs/EndToEndId	EDMLINb073-BizTranId
Transaction Amount /Document/BkToCstmrDbtCdtNfctn/Nfctn/Ntry/NtryDtIs/TxDtIs/Amt	EUR 117.00
Related Parties Debtor BIC BkToCstmrDbtCdtNfctn/Nfctn/Ntry/NtryDtIs/TxDtIs/RltdPtIs/Dbtr/Pty/Id/OrgId/AnyBIC	COBADEFFXXX
Related Parties Creditor BIC BkToCstmrDbtCdtNfctn/Nfctn/Ntry/NtryDtIs/TxDtIs/RltdPtIs/Cdtr/Pty/Id/OrgId/AnyBIC	MARKDEFFXXX

Message item	Utilisation
Related Agents Instructing Agent BIC BkToCstmrDbtCdtNfctn/Nfctn/Ntry/NtryDtls/TxDtls/RltdAgt s/InstgAgt/FinInstnId/BICFI	COBADEFFXXX
Related Agents Instructed Agent BIC BkToCstmrDbtCdtNfctn/Nfctn/Ntry/NtryDtls/TxDtls/RltdAgt s/InstdAgt/FinInstnId/BICFI	MARKDEFFXXX
Local Instrument /Document/BkToCstmrDbtCdtNfctn/Nfctn/Ntry/NtryDtls/Tx Dtls/LclInstrm/Prtry	MLIN

Table 204 - BankToCustomerDebitCreditNotification (camt.054) – usage case automated marginal lending (MLIN to CB) (Scenario 073)

Usage case example: camt.054_CLM_CreditNotification_MLIN_bs073.xml

12.3 Headers (head)

12.3.1 BusinessApplicationHeader (head.001)

12.3.1.1 Overview and scope of the message

This chapter illustrates the *BusinessApplicationHeader* message.

The *BusinessApplicationHeader* (BAH) is used to provide routing and control information (including a digital signature) relating to a single business message.

The consistent structure of relevant information in the BAH facilitates the accurate routing of the business message once it arrives at the technical receiver's interface.

Within the BAH, there are two primary entities defined as FROM and TO which define the business sender and business receiver of the business payload. These business entities may not always be the same as the technical sender and recipient.

The usage of this message is to be found in chapter [Usage of Messages](#) [324].

12.3.1.2 Schema

Outline of the schema

The BAH message is composed of the following message building blocks.

FROM

The business sender that has created this message. FROM BIC must have exactly eleven characters.

TO

The business receiver designated by the sender. TO BIC must have exactly eleven characters.

BusinessMessageIdentifier

Identifies, unambiguously, the message. The BusinessMessageIdentifier has maximum 35 characters.

For inbound messages: In all cases, this value is used by CLM in place of any message ID value which may be provided within the business message.

For outbound messages: Contains the unique message ID from CLM. Any message ID field within the business payload of the payload is populated with "NONREF".

MessageDefinitionIdentifier

Contains the MessageIdentifier that defines the business payload. It must contain a valid ISO 20022 MessageIdentifier supported by CLM.

CreationDate

Date and time when this BAH was created.

CopyDuplicate (optional)

Indicates whether the business payload is a copy, a duplicate or a copy of a duplicate of a previously sent ISO 20022 message. The value is ignored by CLM and not forwarded to the business receiver.

PossibleDuplicate (optional)

Is a flag indicating if the business payload exchanged between sender and receiver is possibly a duplicate. The value is ignored by CLM and forwarded to the business receiver.

Signature (optional)

Contains the digital signature of the business entity authorised to sign this business message.

Related (optional)

Specifies the BAH of the business message to which this business message relates. It can be used when replying to a query; it can also be used when cancelling or amending.

References/links

The CLM-specific schema and documentation in XSD/Excel/PDF format as well as the message examples are provided outside of this document under the following link:

http://www.swift.com/mystandards/CLM/head.001.001.01_CLM

Business rules applicable to the schema

When used in its outbound form from CLM, no business rules are applicable to a *BusinessApplicationHeader* message.

When used in its inbound form, for business rules applicable to *BusinessApplicationHeader* refer to the chapter [Index of validation rules and error codes](#) [▶ 643].

12.3.1.3 The message in business context

The BAH contains information to correctly process the business message. Every message exchanged between CLM and a connected party includes such information. The relationship between the BAH and the business payload is one to one.

Specific message requirements (inbound) and specific message contents (outbound)

All content (inbound) must comply with the business rules for the message.

Message item	Utilisation
From	
Financial Institution Identification /AppHdr/Fr/FIId/FinInstnId/BICFI	BIC of the business sender
Clearing System Identification /AppHdr/Fr/FIId/FinInstnId/ClrSysMmbld/ClrSysId/Prtry	Clearing system identification is not used by CLM. On an inbound message it will be ignored. On an outbound message it will not be filled by CLM.
Clearing System Member Identification /AppHdr/Fr/FIId/FinInstnId/ClrSysMmbld/Mmbld	The clearing system member identification is used to indicate system user reference in inbound messages and is a logical piece of information that allows the identification of one system user in the reference data for a privilege check. Clearing system member identification must be present on BAH level in the case of a single message. In case of outbound messages, clearing system member identification is not present.
Other Identification /AppHdr/Fr/FIId/FinInstnId/Othr/Id	If used in inbound messages, element will be ignored. Outbound: Not used.

Message item	Utilisation
To	
Financial Institution Identification /AppHdr/To/FIId/FinInstnId/BICFI	BIC of the business receiver
Other Identification (Block) /AppHdr/To/FIId/FinInstnId/Othr	If used in inbound messages, element will be ignored. Outbound: Not used.
Header Details	
Business Message Identifier /AppHdr/BizMsgldr	Inbound message: Unique message ID assigned by the business sender. This reference is part of the BAH duplicate check within CLM. Outbound message: Contains the unique message ID assigned by CLM.
Message Definition Identifier /AppHdr/MsgDefldr	Message Identifier is checked by CLM for incoming BAH (the message type has to be supported by CLM). In case of outgoing BAH the published ISO message identifier corresponding to the message payload which follows is used.
Creation Date /AppHdr/CreDt	Date and time the business message was created. Only ZULU time is used.
Copy Duplicate /AppHdr/CpyDplct	In case a business sender is sending a copy, a duplicate or a copy of a duplicate. The value is ignored by CLM and not forwarded to the business receiver.
Possible Duplicate /AppHdr/PssblDplct	If a business sender is sending the message because there is doubt of the previous receiving of the message, this possible duplicate of message will be flagged with "true" – therefore, it could also be the case that the original message meanwhile has been received. If there are no doubts the business sender can flag message with "false". Not used for CLM.

Message item	Utilisation
Priority /AppHdr/Prty	Not used for CLM
Signature /AppHdr/Sgntr	Certificate which identifies the business sending user in combination with the Clearing system member identification for single messages. Note: Either the digital signature is part of the BFH (in case of multi messages) or it is part of the BAH in case of a single message.
Related /AppHdr/Rltd	Inbound: If provided in inbound payment order message or inbound camt.056 it is ignored by CLM. The block <Related> is not mapped into any response or notification.

Table 205 - BusinessApplicationHeader (head.001)

Usage case: CLM Message – Inbound (Scenario 008)

In this usage example, the business sender (a CB with party BIC “MARKDEFFXXX”) is using the header to send a pacs.009 to CLM (BIC “TRGTXEPMCLM”). However, the sender has used the real-time network service to send this urgent instruction instead of the store-and-forward network service. Therefore the whole message fails validation and will be rejected.

Message item	Utilisation
From	
Financial Institution Identification /AppHdr/Fr/FIId/FinInstnId/BICFI	MARKDEFFXXX
Clearing System Member Identification /AppHdr/Fr/FIId/FinInstnId/ClrSysMmbld/Mmbld	BizSenderb008Userld
To	
Financial Institution Identification /AppHdr/To/FIId/FinInstnId/BICFI	TRGTXEPMCLM
Header Details	
Business Message Identifier /AppHdr/BizMsgldr	Inp009b008-BAHId

Message item	Utilisation
Message Definition Identifier /AppHdr/MsgDefldr	pacs.009.001.08
Creation Date /AppHdr/CreDt	2019-10-07T10:00:00Z
Signature /AppHdr/Sgntr	Signature details not available for example message

Table 206 - BusinessApplicationHeader (head.001) – usage case CLM Message – Inbound (Scenario 008)

Message example: Inbound_head.001_CLM_BAH_(CB-to-CLM)_bs008.xml

Usage case: CLM Message – Outbound (Scenario 009)

In this usage example, CLM (BIC “TRGTXEPMCLM”) is using the header to send a camt.054 to a business receiver (BIC “COBADEFFXXX”).

Message item	Utilisation
From	
Financial Institution Identification /AppHdr/Fr/FIId/FinInstnId/BICFI	TRGTXEPMCLM
To	
Financial Institution Identification /AppHdr/To/FIId/FinInstnId/BICFI	COBADEFFXXX
Header Details	
Business Message Identifier /AppHdr/BizMsgldr	Ouc054b009-BAHId
Message Definition Identifier /AppHdr/MsgDefldr	camt.054.001.08
Creation Date /AppHdr/CreDt	2019-10-08T09:42:30.001Z
Signature /AppHdr/Sgntr	Signature details not available for example message

Table 207 - BusinessApplicationHeader (head.001) – usage case CLM Message – Outbound (Scenario 009)

Message example: Outbound_head.001_CLM_BAH_(CLM-to-PB)_bs009.xml

Usage case: CLM Message – Inbound (Scenario 010)

In this usage example, a payment bank business sender (party BIC “COBADEFFXXX”) is using the header to send a camt.050 message to CLM (BIC “TRGTXEPMCLM”):

Message item	Utilisation
From	
Financial Institution Identification /AppHdr/Fr/FIId/FinInstnId/BICFI	COBADEFFXXX
Clearing System Member Identification /AppHdr/Fr/FIId/FinInstnId/ClrSysMmbld/Mmbld	BizSenderb010Userld
To	
Financial Institution Identification /AppHdr/To/FIId/FinInstnId/BICFI	TRGTXEPMCLM
Header Details	
Business Message Identifier /AppHdr/BizMsgldr	Inc050b010-BAHId
Message Definition Identifier /AppHdr/MsgDefldr	camt.050.001.05
Creation Date /AppHdr/CreDt	2019-10-07T13:05:00Z
Signature /AppHdr/Sgntr	Signature details not available for example message

Table 208 - BusinessApplicationHeader (head.001) – usage case CLM Message – Inbound (Scenario 010)

Message example: Inbound_head.001_CLM_BAH_(PB-to-CLM)_bs010.xml

12.3.2 BusinessFileHeader (head.002)

12.3.2.1 Overview and scope of the message

This chapter illustrates the *BusinessFileHeader* message.

The BFH is used by CLM to receive several business messages within one file to CLM.

Under a single BFH, every business message within the file has to be an ISO 20022 (or ISO compliant) message together with its BAH. A file can contain one, or several, business messages.

CLM does not send business messages in files; therefore there is no concept of an outbound BFH from CLM.

Within CLM, the BFH information is used for consistency and completeness checks.

In response to an incoming file which fails validation, CLM sends a [ReceiptAcknowledgement \(admi.007\)](#) [▶ 370] message containing information on the validation error(s).

Results from validation which is performed at file level, are sent without BAH information.

The usage of this message is to be found in chapter [Usage of Messages](#) [▶ 324].

12.3.2.2 Schema

Outline of the schema

The *BusinessFileHeader* is composed of the following building blocks.

PayloadDescription

The PayloadDescription is a mandatory block and contains the following information tags:

- | PayloadDetails with PayloadIdentifier; CreationDateAndTime and PossibleDuplicateFlag,
- | ApplicationSpecificInformation which contains information about the total number of instances (business messages) within the file,
- | PayloadTypeDetails which declares the payload content (describes the standard of business messages being exchanged),
- | ManifestDetails with information to each type of business payload and the number of instances (business payloads) for each declared type of business payload.

Payload

The Payload is a mandatory block and contains the set of business messages, each built of an ISO 20022 message together with its BAH and contained within a head.003 wrapper.

References/links

The CLM-specific schema and documentation in XSD/Excel/PDF format as well as the message examples are provided outside of this document under the following link:

http://www.swift.com/mystandards/CLM/head.002.001.01_CLM

Business rules applicable to the schema

For business rules applicable to *BusinessFileHeader* refer to the chapter [Index of validation rules and error codes](#) [▶ 643].

12.3.2.3 The message in business context

Specific message requirements

All content must comply with the business rules for the message.

Message item	Utilisation
Payload Identifier /Xchg/PyldDesc/PyldDtIs/PyldIdr	The BFH is used to receive several business messages within one file to CLM. The BFH is used for inbound communication only. Under a single BFH, every business message within the file has to be an ISO 20022 (or ISO compliant) message together with its BAH.
Creation Date Time /Xchg/PyldDesc/PyldDtIs/CreDtAndTm	Time offset is mandatory for BFH sent to CLM.
Possible Duplicate /Xchg/PyldDesc/PyldDtIs/PssblDplctFlg	If a technical sender is sending the message because there is doubt of the previous receiving of the file, this possible duplicate of file will be flagged with “true” – therefore, it could also be the case that the original file meanwhile has been received. When there are no doubts the technical sender is flagging with “false”. The value is ignored by CLM.
System User /Xchg/PyldDesc/ApplSpfcInf/SysUsr	The system user reference is a logical piece of information that allows the identification of one system user in the reference data for a privilege check. The provision of the system user reference is mandatory for inbound BFH and replaces the use of Clearing system member identification at BAH level. If the Clearing system member identification is additionally provided on BAH level, the BFH user will be used and the BAH user will be ignored.
Signature /Xchg/PyldDesc/ApplSpfcInf/Sgntr	Certificate, which identifies the business sending user in combination with the system user for files. The signature is part of the file header (BFH). It is over the list of BAHs, ISO 20022 messages and their head.003 wrappers. If the signature is additionally provided on BAH-level within the single message, the BFH signature will be used and the

Message item	Utilisation
	BAH signature will be ignored.
Total Number Of Documents /Xchg/PyldDesc/ApplSpfcInf/TtlNbOfDocs	Total number of messages contained within the file. Not validated by CLM.
Payload Type Details /Xchg/PyldDesc/PyldTpDtIs/Tp	Exchanged payload belongs exclusively to the ISO 20022 Standard family.
Multiple Manifest Details	
Document Type /Xchg/PyldDesc/MnfstDtIs/DocTp	ISO message type (e.g. camt.050.001.05). Not validated by CLM.
Number Of Documents /AppHdr/BizMsgldr	Total number of message instances per single message type contained within the file. Not validated by CLM.
Multiple Payload	
Payload /Xchg/Pyld	The head.003 XSD file is used as a technical wrapper to structure the ExchangePayload for head.002, the specific schema as XSD file is provided under the same link.

Table 209 - BusinessFileHeader (head.002)

Usage case: CLM File (Scenario 011)

In this usage example, the business sender is using the header to send a file (identified as “Inh002b011-Field”) containing three messages to CLM:

Message item	Utilisation
Payload Identifier /Xchg/PyldDesc/PyldDtIs/Pyldldr	Inh002b011-Field
Creation Date Time /Xchg/PyldDesc/PyldDtIs/CreDtAndTm	2019-10-07T11:40:00+00:00
System User /Xchg/PyldDesc/ApplSpfcInf/SysUsr	BizSenderb011Userld
Total Number Of Documents /Xchg/PyldDesc/ApplSpfcInf/TtlNbOfDocs	3

Fehler! Verwenden Sie die Registerkarte 'Start', um dem Text zuzuweisen,

Message item	Utilisation
Payload Type Details /Xchg/PyldDesc/PyldTpDtIs/Tp	ISO20022
Multiple Payload	
Payload /Xchg/Pyld	Different messages (BAH + business payload)

Table 210 - BusinessFileHeader (head.002) – usage case CLM File (Scenario 011)

Message example: Inbound_head.002_CLM_BFH_(PB-to-CLM)_bs011.xml

Usage case: CLM File (Scenario 012)

In this usage example, the business sender is using the header to send a file (identified as “Inh002b012-Feld”) containing five messages to CLM:

Message item	Utilisation
Payload Identifier /Xchg/PyldDesc/PyldDtIs/PyldIdr	Inh002b012-Feld
Creation Date Time /Xchg/PyldDesc/PyldDtIs/CreDtAndTm	2019-10-07T11:40:00+00:00
System User /Xchg/PyldDesc/ApplSpfcInf/SysUsr	BizSenderb012UserId
Total Number Of Documents /Xchg/PyldDesc/ApplSpfcInf/TtINbOfDocs	5
Payload Type Details /Xchg/PyldDesc/PyldTpDtIs/Tp	ISO20022
Multiple Payload	
Payload /Xchg/Pyld	Different messages (BAH + business payload)

Table 211 - BusinessFileHeader (head.002) – usage case CLM File (Scenario 012)

Message example: Inbound_head.002_CLM_BFH_(PB-to-CLM)_bs012.xml

13 List of messages specific for CBs

This chapter illustrates the messages which are exclusively for CBs usage. These messages can be only send/received by CBs and have a CB specific schema.

Chapter	Message code	Message name
Cash management (camt)		
ResolutionOfInvestigation (camt.029) [▶ 561]	camt.029	ResolutionOfInvestigation
General ledger (camt.053) [▶ 567]	camt.053	BankToCustomerStatement
FIToFIPaymentCancellationRequest (camt.056) [▶ 573]	camt.056	FIToFIPaymentCancellationRequest
Credit line management (camt)		
ModifyCreditLine (camt.998) - specific for CBs [▶ 580]	camt.998	ModifyCreditline
Minimum reserve management (camt)		
AuthorizePenaltyMinimumReserve (camt.998) - specific for CBs [▶ 584]	camt.998	AuthorizePenaltyMinimumReserve
GetPenaltyMinimumReserve (camt.998) - specific for CBs [▶ 588]	camt.998	GetPenaltyMinimumReserve
ReturnPenaltyMinimumReserve (camt.998) - specific for CBs [▶ 591]	camt.998	ReturnPenaltyMinimumReserve
InsertValueOfReserveMinimumReserve (camt.998) - specific for CBs [▶ 600]	camt.998	InsertValueOfReserveMinimumReserve
InsertBalanceMinimumReserve (camt.998) - specific for CBs [▶ 604]	camt.998	InsertBalanceMinimumReserve
ReturnPeriodicInformationMinimumReserve (camt.998) - specific for CBs [▶ 608]	camt.998	ReturnPeriodicInformationMinimumReserve
Payments clearing and settlement (pacs)		

Chapter	Message code	Message name
PaymentStatusReport (pacs.002) [▶ 615]	pacs.002	PaymentStatusReport
FinancialInstitutionCreditTransfer (pacs.009) [▶ 624]	pacs.009	FinancialInstitutionCreditTransfer
FinancialInstitutionDirectDebit (pacs.010) [▶ 633]	pacs.010	FinancialInstitutionDirectDebit

Table 212 - List of messages specific for CBs

13.1 Cash management (camt)

13.1.1 ResolutionOfInvestigation (camt.029)

13.1.1.1 Overview and scope of the message

This chapter illustrates the *ResolutionOfInvestigation* message.

The *ResolutionOfInvestigation* message is sent by CLM to a business receiver in response to a [FIToFIPaymentCancellationRequest \(camt.056\)](#) [▶ 573] to inform about the status of the previously requested payment order revocation.

The *ResolutionOfInvestigation* message concerns the revocation of only one payment order and provides details of the underlying payment order and the related statuses for which the revocation request has been issued.

The usage of this message is to be found in chapter [Usage of Messages](#) [▶ 324].

13.1.1.2 Schema

Outline of the schema

The *ResolutionOfInvestigation* message is composed of the following message building blocks.

Assignment

This block is mandatory and non-repetitive. It identifies the assignment of an investigation case from an assigner to an assignee. The assigner must be the sender of this business message and the assignee must be the business receiver.

Status

Indicates the status of the previously sent cancellation request.

Cancellation Details

Specifies some of the details of the underlying payment order being revoked.

References/links

The CLM-specific schema and documentation in XSD/Excel/PDF format as well as the message examples are provided outside of this document under the following link:

http://www.swift.com/mystandards/CLM/camt.029.001.09_CLM

Business rules applicable to the schema

No business rules are applicable to a *ResolutionOfInvestigation* message.

13.1.1.3 The message in business context

Specific message contents

Message item	Utilisation
Assignment	
Identification /Document/RsltnOfInvstgtn/Assgnmt/Id	Value "NONREF" as the message ID is already part of the BAH.
Assigner Agent BIC /Document/RsltnOfInvstgtn/Assgnmt/Assgnr/Agt/FinInstnId/BICFI	Equivalent to the <InstructingAgent> of the underlying payment order. The Assigner is copied from the camt.056
Assignee Agent BIC /Document/RsltnOfInvstgtn/Assgnmt/Assgne/Agt/FinInstnId/BICFI	Equivalent to the <InstructedAgent> of the underlying payment order. The Assignee is copied from the camt.056
Creation Date Time /Document/RsltnOfInvstgtn/Assgnmt/CreDtTm	Date and time at which the assignment was created.
Confirmation /Document/RsltnOfInvstgtn/Sts/Conf	<ul style="list-style-type: none"> CNCL = Cancelled as per request RJCR = Rejected cancellation request
Cancellation Details	
Original Message Identification	Copy of BAH BizMsgIdr of the original payment order

Message item	Utilisation
/Document/RsltOfInvstgtn/CxlDtls/TxInfAndSts/OrgnlGrpIn f/OrgnlMsgId	pacs.009 or pacs.010.
Original Message Name Identification /Document/RsltOfInvstgtn/CxlDtls/TxInfAndSts/OrgnlGrpIn f/OrgnlMsgNmId	Message name of the underlying payment order copied from the triggering camt.056 cancellation request: pacs.009.001.xx, pacs.010.001.xx.
Original End to End Identification /Document/RsltOfInvstgtn/CxlDtls/TxInfAndSts/OrgnlEndT oEndId	Instruction identification of the underlying payment order. Copied from the triggering camt.056 cancellation request
Original UETR /Document/RsltOfInvstgtn/CxlDtls/TxInfAndSts/OrgnlUET R	UETR of the underlying payment order. Copied from the triggering camt.056 cancellation request
Reason /Document/RsltOfInvstgtn/CxlDtls/TxInfAndSts/CxlStsRsnl nf/Rsn/Prtry	In case of error/failure a CLM rejection reason code will be used. Details are provided in " Index of validation rules and error codes [643]" in CLM UDFS.
Additional Information /Document/RsltOfInvstgtn/CxlDtls/TxInfAndSts/CxlStsRsnl nf/AddtlInf	Detailed error description

Table 213 - ResolutionOfInvestigation (camt.029)

Usage case: Payment Order Revocation Execution Notification (Scenario 003)

In this usage example, CLM is advising the business sender of a previous [FIToFIPaymentCancellationRequest \(camt.056\)](#) [573] that the payment (with UETR: "e009b003-59c5-41e9-be4c-d45102fc201e") has been successfully cancelled and will never reach settlement. To ensure clarity, the [ResolutionOfInvestigation \(camt.029\)](#) [561] message includes several data copied from the requesting [FIToFIPaymentCancellationRequest \(camt.056\)](#) [573] message: the original message ID, the original end-to-end identification and the UETR. The message was created and sent on 7 October at 15:01 CET, one minute after the inbound [FIToFIPaymentCancellationRequest \(camt.056\)](#) [573] was sent.

Message item	Utilisation
Assignment	
Identification /Document/RsltOfInvstgtn/Assgnmt/Id	NONREF
Assigner Agent BIC	MARKDEFFXXX

Message item	Utilisation
/Document/RsltOfInvstgtn/Assgnmt/Assgnr/Agt/FinInstnId/BICFI	
Assignee Agent BIC	SOLADESTXXX
/Document/RsltOfInvstgtn/Assgnmt/Assgne/Agt/FinInstnId/BICFI	
Creation Date Time	2019-10-07T15:01:00.001+00:00
/Document/RsltOfInvstgtn/Assgnmt/CreDtTm	
Confirmation	CNCL
/Document/RsltOfInvstgtn/Sts/Conf	
Cancellation Details	
Original Message Identification	Inp009b003-BAHId
/Document/RsltOfInvstgtn/CxlDtIs/TxInfAndSts/OrgnlGrpInf/OrgnlMsgId	
Original Message Name Identification	pacs.009.001.08
/Document/RsltOfInvstgtn/CxlDtIs/TxInfAndSts/OrgnlGrpInf/OrgnlMsgNmId	
Original End to End Identification	Inp009b003-E2EId
/Document/RsltOfInvstgtn/CxlDtIs/TxInfAndSts/OrgnlEndToEndId	
Original UETR	e009b003-59c5-41e9-be4c-d45102fc201e
/Document/RsltOfInvstgtn/CxlDtIs/TxInfAndSts/OrgnlUETR	

Table 214 - ResolutionOfInvestigation (camt.029) – usage case Payment Order Revocation Execution Notification (Scenario 003)

Usage case example: **Outbound_camt.029_CLM_PaymentCancellationRequestStatus_Execution_bs003.xml**

Usage case: Revocation Rejection Notification (Scenario 004)

In this usage example, CLM is advising the business sender of a previous [FIToFIPaymentCancellationRequest \(camt.056\)](#) [▶ 573] that the cancellation request has been rejected and the payment remains eligible for settlement. The reason for rejection is provided, in this case code “E053” with a description of “No payment found”, because the original amount was 285000, whereas the amount for the cancellation request is 2850. Therefore no matching between payment and cancellation request is possible. To ensure clarity, the [ResolutionOfInvestigation \(camt.029\)](#) [▶ 561] message includes several data

copied from the requesting [FIToFIPaymentCancellationRequest \(camt.056\)](#) [▶ 573] message: the original message ID, the original end-to-end identification and the UETR. The message was created and sent on 7 October at 15:01 CET, one minute after the inbound [FIToFIPaymentCancellationRequest \(camt.056\)](#) [▶ 573] was sent.

Message item	Utilisation
Assignment	
Identification /Document/RsltOfInvstgtn/Assgnmt/Id	NONREF
Assigner Agent BIC /Document/RsltOfInvstgtn/Assgnmt/Assgnr/Agt/FinInstnId/ BICFI	MARKDEFFXXX
Assignee Agent BIC /Document/RsltOfInvstgtn/Assgnmt/Assgne/Agt/FinInstnId /BICFI	SOLADESTXXX
Creation Date Time /Document/RsltOfInvstgtn/Assgnmt/CreDtTm	2019-10-07T15:01:00.001+00:00
Confirmation /Document/RsltOfInvstgtn/Sts/Conf	RJCR
Cancellation Details	
Original Message Identification /Document/RsltOfInvstgtn/CxlDtIs/TxInfAndSts/OrgnlGrpIn f/OrgnlMsgId	Inp009b004-BAHId
Original Message Name Identification /Document/RsltOfInvstgtn/CxlDtIs/TxInfAndSts/OrgnlGrpIn f/OrgnlMsgNmId	pacs.009.001.08
Original End to End Identification /Document/RsltOfInvstgtn/CxlDtIs/TxInfAndSts/OrgnlEndT oEndId	Inp009b004-E2EId

Message item	Utilisation
Original UETR /Document/RsltOfInvstgtn/CxlDtls/TxInfAndSts/OrgnIUETR	e009b004-59c5-41e9-be4c-d45102fc201e
Reason /Document/RsltOfInvstgtn/CxlDtls/TxInfAndSts/CxlStsRsnlnf/Rsn/Prtry	E053
Additional Information /Document/RsltOfInvstgtn/CxlDtls/TxInfAndSts/CxlStsRsnlnf/AddtlInf	No payment found

Table 215 - ResolutionOfInvestigation (camt.029) – usage case Revocation Rejection Notification (Scenario 004)

Usage case example:
Outbound_camt.029_CLM_PaymentCancellationRequestStatus_Rejection_bs004.xml

Usage case: Revocation Rejection Notification (Scenario 007)

In this usage example, CLM is advising the business sender of a previous [FIToFIPaymentCancellationRequest \(camt.056\)](#) [▶ 573] that the cancellation request has been rejected and the direct debit remains eligible for settlement. The reason for rejection is provided, in this case code “E053” with a description of “No payment found”, because the original amount was 47000, whereas the amount for the cancellation request is 470. Therefore no matching between payment and cancellation request is possible. To ensure clarity, the [ResolutionOfInvestigation \(camt.029\)](#) [▶ 561] message includes several data copied from the requesting [FIToFIPaymentCancellationRequest \(camt.056\)](#) [▶ 573] message: the original message ID, the original end-to-end identification and the UETR. The message was created and sent on 7 October at 15:01 CET, one minute after the inbound [FIToFIPaymentCancellationRequest \(camt.056\)](#) [▶ 573] was sent.

Message item	Utilisation
Assignment	
Identification /Document/RsltOfInvstgtn/Assgnmt/Id	NONREF
Assigner Agent BIC /Document/RsltOfInvstgtn/Assgnmt/Assgnr/Agt/FinInstnId/BICFI	MARKDEFFXXX
Assignee Agent BIC /Document/RsltOfInvstgtn/Assgnmt/Assgne/Agt/FinInstnId/BICFI	COBADEFFXXX

Message item	Utilisation
Creation Date Time /Document/RsltnOfInvstgtn/Assgnmt/CreDtTm	2019-10-07T15:01:00.001+00:00
Confirmation /Document/RsltnOfInvstgtn/Sts/Conf	RJCR
Cancellation Details	
Original Message Identification /Document/RsltnOfInvstgtn/CxlDtls/TxInfAndSts/OrgnlGrpIn f/OrgnlMsgld	Inp010b007-BAHId
Original Message Name Identification /Document/RsltnOfInvstgtn/CxlDtls/TxInfAndSts/OrgnlGrpIn f/OrgnlMsgNmld	pacs.010.001.03
Original End to End Identification /Document/RsltnOfInvstgtn/CxlDtls/TxInfAndSts/OrgnlEndT oEndld	Inp010b007-E2EId
Original UETR /Document/RsltnOfInvstgtn/CxlDtls/TxInfAndSts/OrgnlUET R	e010b007-59c5-41e9-be4c-d45102fc201e
Reason /Document/RsltnOfInvstgtn/CxlDtls/TxInfAndSts/CxlStsRsnl nf/Rsn/Prtry	E053
Additional Information /Document/RsltnOfInvstgtn/CxlDtls/TxInfAndSts/CxlStsRsnl nf/AddtlInf	No payment found

Table 216 - ResolutionOfInvestigation (camt.029) – usage case Revocation Rejection Notification (Scenario 007)

Usage **case** **example:**
Outbound_camt.029_CLM_PaymentCancellationRequestStatus_Rejection_bs007.xml

13.1.2 General ledger (camt.053)

13.1.2.1 Overview and scope of the message

This chapter illustrates the *General Ledger* message.

The general ledger *BankToCustomerStatement* message is created during the EoD process and sent by CLM to CBs and the ECB to inform of the entries posted to an account and the account balance information at EoD. It is generated for each single CB and for the ECB containing the data pertaining exclusively for the CB or the ECB for which it is produced.

The general ledger *BankToCustomerStatement* message provides information for cash management and/or the reconciliation of information for posted/settled entries only. CLM will collect general ledger information from the settlement services (RTGS, CLM, TIPS, T2S) and distribute one general ledger *BankToCustomerStatement* message per settlement service and currency.

The message will be sent to the business receiver either:

- | immediately after creation;
- | in response to a [ReportQueryRequest \(admi.005\)](#) [▶ 368] message.

Note: *General ledger* is not subject to pagination. But as CB receives one *General ledger* per service, an ReceiptAcknowledgement (admi.007) message is sent by CLM in response to the [ReportQueryRequest \(admi.005\)](#) [▶ 368] message to the business sender of the *General Ledger* query (CB only) to indicate the change of response network service to store-n-forward.

The usage of this message is to be found in chapter [Usage of Messages](#) [▶ 324].

13.1.2.2 Schema

Outline of the schema

The *BankToCustomerStatement* message is composed of the following message building blocks.

GroupHeader

This building block is mandatory and non-repetitive. It must contain an identification assigned by the sending party to uniquely and unambiguously identify the message.

Statement

This building block is mandatory and repetitive. It shows information on posted entries and balances for a CLM MCA. It may contain:

- | statement identification;
- | creation timestamp;
- | account identification;
- | account balance/s;
- | summary of transactions;
- | details of each entry: entry reference, amount and currency, debit/credit indicator, status, booking date, value date, bank transaction code, entry details and additional entry information.

References/links

The CLM-specific schema and documentation in XSD/Excel/PDF format as well as the message examples are provided outside of this document under the following link:

http://www.swift.com/mystandards/CLM/camt.053.001.08_CLM_GeneralLedger

Business rules applicable to the schema

No business rules are applicable to a *BankToCustomerStatement* message.

13.1.2.3 The message in business context

Specific message contents

Message item	Utilisation
Message Identification /Document/BkToCstmrStmnt/GrpHdr/MsgId	Value "NONREF" as the message ID is already part of the BAH
Creation Date Time Document/BkToCstmrStmnt/GrpHdr/CreDtTm	Date and time at which the message was created
Additional Information /Document/BkToCstmrStmnt/GrpHdr/AddtlInf	Fixed content "General Ledger"
Statement	
Identification Document/BkToCstmrStmnt/Stmnt/ID	Identification of the settlement service for which the general ledger is produced. Possible values are: <ul style="list-style-type: none"> CLM RTGS T2S TIPS
Account /Document/BkToCstmrStmnt/Stmnt/Acct/Id/Othr/Id	Account number of reported account
Owner /Document/BkToCstmrStmnt/Stmnt/Acct/Ownr/Id/OrgId/AnyBlC	Party BIC owning the cash account. For overnight deposit and marginal lending accounts the account owner BIC is the party BIC of the responsible CB.
Two repetitions of balance information	

Message item	Utilisation
Balance type /Document/BkToCstmrStmnt/Stmnt/Bal/Tp/CdOrPrty/Cd	Balance type code of the reported account balance: <ul style="list-style-type: none"> OPBD = Balance at SoD, CLBD = Balance at EoD.
Amount /Document/BkToCstmrStmnt/Stmnt/Bal/Amt/	Amount of money of the cash balance.
Credit Debit Indicator /Document/BkToCstmrStmnt/Stmnt/Bal/CdtDbtInd	Indicates whether the balance is a credit or a debit. Usage: A zero balance is considered to be a credit balance. <ul style="list-style-type: none"> CRDT = Credit balance DBIT = Debit balance
Date /Document/BkToCstmrStmnt/Stmnt/Bal/Dt/Dt	Date of business day of the reported balance.
Transaction Summary	
In the case of message pagination this information is only provided in the first camt.053 and contains all entries for the reported settlement service.	
Total Credit Entries /Document/BkToCstmrStmnt/Stmnt/TxsSummry/TtlCdtNtries/ Sum	Total sum of all credit entries in the report. The amount is formatted in 18/2 and is provided without currency code.
Total Debit Entries /Document/BkToCstmrStmnt/Stmnt/TxsSummry/TtlDbtNtries/ Sum	Total sum of all of debit entries in the report. The amount is formatted in 18/2 and is provided without currency code.
Multiple repetitions of entry	
Entry Reference /Document/BkToCstmrStmnt/Stmnt/Ntry/NtryRef	Identification of the settlement service related to the multilateral cross-CB turnover.
Amount /Document/BkToCstmrStmnt/Stmnt/Ntry/Amt	Settled amount of the multilateral cross-CB turnover.
Credit Debit Indicator /Document/BkToCstmrStmnt/Stmnt/Ntry/CrdDbtInd	Indicates whether the entry is a credit or a debit. <ul style="list-style-type: none"> CRDT = Operation is an increase DBIT = Operation is a decrease
Status /Document/BkToCstmrStmnt/Stmnt/Ntry/Sts/Cd	Only entry status "BOOK" is used
Booking Date	Time stamp including the calendar date of the settlement of

Message item	Utilisation
/Document/BkToCstmrStmnt/Stmnt/Ntry/BookgDt/DtTm	the multilateral cross-CB turnover.
Value Date	Date of business day of the settlement of the multilateral cross-CB turnover.
/Document/BkToCstmrStmnt/Stmnt/Ntry/ValDt/Dt	
Bank Transaction Code	PMNT = Used for payment
/Document/BkToCstmrStmnt/Stmnt/Ntry/BkTxCd/Prtry/Cd	
Entry Details	
Clearing System Reference	Booking reference of the settled multilateral cross-CB turnover.
/Document/BkToCstmrStmnt/Stmnt/Ntry/NtryDtls/TxDtls/Refs/ClrSysRef	
Additional Entry Information	Country code of CB counterpart of the multilateral cross-CB turnover.
/Document/BkToCstmrStmnt/Stmnt/Ntry/AddtlNtryInf	

Table 217 - BankToCustomerStatement (camt.053) – general ledger

Usage case: General Ledger (CB Only) - ECB CLM General Ledger File

In this usage example, CLM delivers a general ledger file to the ECB for CLM accounting and reserve management purposes.

Specific message content

The message content can be found in the usage case example below.

Usage case example: camt.053_CLM_BankToCustomerStatement_ECB_GeneralLedger_Example.xml

Usage case: General Ledger (CB Only) - CB CLM General Ledger File

In this usage example, CLM delivers a general ledger file to the CBs for CLM accounting and reserve management purposes. The CBs are being informed of all movements occurring on general ledger accounts in their data scope. This report message is automatically generated by CLM in accordance with the reporting configuration settings applied by the CBs.

Specific message content

The message content can be found in the usage case example below.

Usage case example: camt.053_CLM_BankToCustomerStatement_CB_GeneralLedger_Example.xml

Usage case: General Ledger (CB Only) - ECB RTGS General Ledger File

In this usage example, CLM delivers a general ledger file to the ECB for RTGS accounting and reserve management purposes.

Specific message content

The message content can be found in the usage case example below.

Usage case example:
camt.053_RTGS_BankToCustomerStatement_ECB_GeneralLedger_Example.xml

Usage case: General Ledger (CB Only) - CB RTGS General Ledger File

In this usage example, CLM delivers a general ledger file to the CBs for RTGS accounting and reserve management purposes. The CBs are being informed of all movements occurring on general ledger accounts in their data scope. This report message is automatically generated by CLM in accordance with the reporting configuration settings applied by the CBs.

Specific message content

The message content can be found in the usage case example below

Usage case example: camt.053_RTGS_BankToCustomerStatement_CB_GeneralLedger_Example.xml

Usage case: General Ledger (CB Only) - ECB TIPS General Ledger File

In this usage example, CLM delivers a general ledger file to the ECB for TIPS accounting and reserve management purposes.

Specific message content

The message content can be found in the usage case example below.

Usage case example: camt.053_TIPS_BankToCustomerStatement_ECB_GeneralLedger_Example.xml

Usage case: General Ledger (CB Only) - CB TIPS General Ledger File

In this usage example, CLM delivers a general ledger file to the CBs for TIPS accounting and reserve management purposes. The CBs are being informed of all movements occurring on general ledger accounts in their data scope. This report message is automatically generated by CLM in accordance with the reporting configuration settings applied by the CBs.

Specific message content

The message content can be found in the usage case example below.

Usage case example: camt.053_TIPS_BankToCustomerStatement_CB_GeneralLedger_Example.xml

13.1.3 FIToFIPaymentCancellationRequest (camt.056)

13.1.3.1 Overview and scope of the message

This chapter illustrates the *FIToFIPaymentCancellationRequest* message.

The *FIToFIPaymentCancellationRequest* message is sent by a business sender to CLM. It is used to request the revocation of a payment order.

The message can be sent by the following business sender:

- I CB.

The *FIToFIPaymentCancellationRequest* message concerns only one original payment message.

The *FIToFIPaymentCancellationRequest* message is used to revoke the following types of payment order:

- I [FinancialInstitutionCreditTransfer \(pacs.009\)](#) [▶ 624],
- I [FinancialInstitutionDirectDebit \(pacs.010\)](#) [▶ 633].

The usage of this message is to be found in chapter [Usage of Messages](#) [▶ 324].

In the case of a successful revocation CLM sends, in response to the *FIToFIPaymentCancellationRequest* message, a [ResolutionOfInvestigation \(camt.029\)](#) [▶ 561] message indicating the successful execution of the revocation request. Additionally, a related [PaymentStatusReport \(pacs.002\)](#) [▶ 615] message will be sent to the business sender of the original payment order.

In the case of rejection/failure of the revocation request CLM sends, in response to the *FIToFIPaymentCancellationRequest* message, a [ResolutionOfInvestigation \(camt.029\)](#) [▶ 561] with the appropriate error code(s) and error description(s).

13.1.3.2 Schema

Outline of the schema

The *FIToFIPaymentCancellationRequest* message is composed of the following message building blocks.

Assignment

This block is mandatory and non-repetitive. It identifies the assignment of an investigation case from an assigner (equal to *InstructingAgent* in the payment to be revoked) to an assignee (equal to *InstructedAgent* in the payment to be revoked).

Underlying

This block is mandatory and non-repetitive. It identifies the original payment order to be revoked. It contains the following elements:

- | cancellation identification;
- | original group information;
- | original instruction identification
- | original end-to-end identification;
- | original UETR;
- | original clearing system reference;
- | original interbank settlement amount;
- | original interbank settlement date;
- | cancellation reason information.

References/links

The CLM-specific schema and documentation in XSD/Excel/PDF format as well as the message examples are provided outside of this document under the following link:

http://www.swift.com/mystandards/CLM/camt.056.001.08_CLM

Business rules applicable to the schema

For business rules applicable to *FIToFIPaymentCancellationRequest* refer to the chapter [Index of validation rules and error codes](#) [▶ 643].

13.1.3.3 The message in business context

Specific message requirements

All content must comply with the business rules for the message.

Message item	Utilisation
Assignment	
Identification /Document/FIToFIPmtCxlReq/Assgnmt/Id	Value "NONREF" as the message ID is already part of the BAH
Assigner Agent BIC /Document/FIToFIPmtCxlReq/Assgnmt/Assgnr/Agt/FinInstnId/BICFI	Must be identical to the instructing agent of the payment
Assignee Agent BIC /Document/FIToFIPmtCxlReq/Assgnmt/Assgne/Agt/FinInstnId/BICFI	Must be identical to the instructed agent of the payment

Message item	Utilisation
Creation Date Time /Document/FIToFIPmtCxlReq/Assgnmt/CreDtTm	Date and time at which the assignment was created
Underlying	
Cancellation Identification /Document/FIToFIPmtCxlReq/Undrlyg/TxInf/Cxld	If provided it is ignored by CLM
Original Message Identification /Document/FIToFIPmtCxlReq/Undrlyg/TxInf/OrgnlGrplnf/OrgnlMsgld	Refers to the message ID of the original payment message
Original Message Name Identification /Document/FIToFIPmtCxlReq/Undrlyg/TxInf/OrgnlGrplnf/OrgnlMsgNmld	Message name of the underlying payment order: <ul style="list-style-type: none"> pacs.009.001.xx, pacs.010.001.xx.
Original Creation Date Time /Document/FIToFIPmtCxlReq/Undrlyg/TxInf/OrgnlGrplnf/OrgnlCreDtTm	Original date and time at which the message was created
Original Instruction Identification /Document/FIToFIPmtCxlReq/Undrlyg/TxInf/OrgnlInstrld	If present in the underlying payment message, the Instruction Identification must be transported in the camt.056.
Original End to End Identification /Document/FIToFIPmtCxlReq/Undrlyg/TxInf/OrgnlEndToEndld	Must contain the information available under End-to-End identification of the underlying payment message.
Original UETR /Document/FIToFIPmtCxlReq/Undrlyg/TxInf/OrgnlUETR	Provide the original UETR of the payment transaction.
Original Clearing System Reference /Document/FIToFIPmtCxlReq/Undrlyg/TxInf/OrgnlClrSysRef	Optional because it might not exist if the transaction is still pending.

Message item	Utilisation
Original Interbank Settlement Amount /Document/FIToFIPmtCxlReq/Undrlyg/TxInf/OrgnlIntrBkSttl mAmt	Amount of money moved between the instructing agent and the instructed agent, as provided in the original instruction.
Original Interbank Settlement Date /Document/FIToFIPmtCxlReq/Undrlyg/TxInf/OrgnlIntrBkSttl mDt	Date, as provided in the original transaction, on which the amount of money ceases to be available to the agent that owes it and when the amount of money becomes available to the agent to which it is due.
Cancellation Reason Code /Document/FIToFIPmtCxlReq/Undrlyg/TxInf/CxlRsnInf/Rsn/ Cd	SYAD (system administrator) accepted by CLM only. CLM does not forward camt.056 by default.

Table 218 - FIToFIPaymentCancellationRequest (camt.056)

Usage case: Payment Order Revocation Request (Scenario 003)

In this usage example, the business sender (CB) has requested that a previously instructed payment (with UETR: "e009b003-59c5-41e9-be4c-d45102fc201e") should be revoked and therefore never able to reach settlement. To ensure the correct payment is identified, the cancellation includes several data from the original pacs.009 message: the BAH-BizMsgIldr, the end-to-end identification, the payment amount (EUR 450,000) and the settlement date (2019-10-08). The message was created and sent on 7 October at 15:00. Therefore it is expected that the payment (sent at 14:15 on 7 October) has not yet settled.

Message item	Utilisation
Assignment	
Identification /Document/FIToFIPmtCxlReq/Assgnmt/Id	NONREF
Assigner Agent BIC /Document/FIToFIPmtCxlReq/Assgnmt/Assgnr/Agt/FinInstn Id/BICFI	MARKDEFFXXX
Assignee Agent BIC /Document/FIToFIPmtCxlReq/Assgnmt/Assgne/Agt/FinInst nId/BICFI	SOLADESTXXX
Creation Date Time /Document/FIToFIPmtCxlReq/Assgnmt/CreDtTm	2019-10-07T15:00:00+00:00
Underlying	
Original Message Identification	Inp009b003-BAHId

Message item	Utilisation
/Document/FIToFIPmtCxlReq/Undrlyg/TxInf/OrgnlGrplnf/OrgnlMsgld	
Original Message Name Identification /Document/FIToFIPmtCxlReq/Undrlyg/TxInf/OrgnlGrplnf/OrgnlMsgNmlId	pacs.009.001.08
Original End to End Identification /Document/FIToFIPmtCxlReq/Undrlyg/TxInf/OrgnlEndToEndId	Inp009b003-E2EId
Original UETR /Document/FIToFIPmtCxlReq/Undrlyg/TxInf/OrgnlUETR	e009b003-59c5-41e9-be4c-d45102fc201e
Original Interbank Settlement Amount /Document/FIToFIPmtCxlReq/Undrlyg/TxInf/OrgnlIntrBkSttlmAmt	EUR 450000
Original Interbank Settlement Date /Document/FIToFIPmtCxlReq/Undrlyg/TxInf/OrgnlIntrBkSttlmDt	2019-10-08
Code /Document/FIToFIPmtCxlReq/Undrlyg/TxInf/CxlRsnInf/Rsn/Cd	SYAD

Table 219 - FIToFIPaymentCancellationRequest (camt.056) – usage case Payment Order Revocation Request (Scenario 003)

Usage case example: Inbound_camt.056_CLM_PaymentCancellationRequest_bs003.xml

Usage case: Payment Order Revocation Request (Scenario 004)

In this usage example, the business sender (CB) has requested that a previously instructed payment (with UETR: “e009b004-59c5-41e9-be4c-d45102fc201e”) should be revoked and therefore never able to reach settlement. To ensure the correct payment is identified, the cancellation includes several data from the original pacs.009 message: the BAH-BizMsgldr, the end-to-end identification, the payment amount (EUR 2850) and the settlement date (2019-10-09). The message was created and sent on 7 October at 15:00. Therefore it is expected that the payment (sent at 14:15 on 7 October) has not yet settled.

Message item	Utilisation
Assignment	
Identification	NONREF

Message item	Utilisation
/Document/FIToFIPmtCxlReq/Assgnmt/Id	
Assigner Agent BIC /Document/FIToFIPmtCxlReq/Assgnmt/Assgnr/Agt/FinInstn Id/BICFI	MARKDEFFXXX
Assignee Agent BIC /Document/FIToFIPmtCxlReq/Assgnmt/Assgne/Agt/FinInst nId/BICFI	SOLADESTXXX
Creation Date Time /Document/FIToFIPmtCxlReq/Assgnmt/CreDtTm	2019-10-07T15:00:00+00:00
Underying	
Original Message Identification /Document/FIToFIPmtCxlReq/Undrlyg/TxInf/OrgnlGrplnf/Or gnlMsgld	Inp009b004-BAHId
Original Message Name Identification /Document/FIToFIPmtCxlReq/Undrlyg/TxInf/OrgnlGrplnf/Or gnlMsgNmld	pacs.009.001.08
Original End to End Identification /Document/FIToFIPmtCxlReq/Undrlyg/TxInf/OrgnlEndToEn dId	Inp009b004-E2EId
Original UETR /Document/FIToFIPmtCxlReq/Undrlyg/TxInf/OrgnlUETR	e009b004-59c5-41e9-be4c-d45102fc201e
Original Interbank Settlement Amount /Document/FIToFIPmtCxlReq/Undrlyg/TxInf/OrgnlIntrBkSttl mAmt	EUR 2850
Original Interbank Settlement Date /Document/FIToFIPmtCxlReq/Undrlyg/TxInf/OrgnlIntrBkSttl mDt	2019-10-09
Code /Document/FIToFIPmtCxlReq/Undrlyg/TxInf/CxlRsnInf/Rsn/ Cd	SYAD

Table 220 - FIToFIPaymentCancellationRequest (camt.056) – usage case Payment Order Revocation Request (Scenario 004)

Usage case example: Inbound_camt.056_CLM_PaymentCancellationRequest_bs004.xml

Usage case: Payment Order Revocation Request (Scenario 007)

In this usage example, the business sender (CB) has requested that a previously instructed direct debit (with UETR: "e010b007-59c5-41e9-be4c-d45102fc201e") should be revoked and therefore never able to reach settlement. To ensure the correct direct debit movement is identified, the cancellation includes several data from the original pacs.010 message: the BAH-BizMsgldr, the end-to-end identification, the payment amount (EUR 470) and the settlement date (2019-10-09). The message was created and sent on 7 October at 15:00. Therefore it is expected that the direct debit (sent at 09:00 on 7 October) has not yet settled.

Message item	Utilisation
Assignment	
Identification /Document/FIToFIPmtCxlReq/Assgnmt/Id	NONREF
Assigner Agent BIC /Document/FIToFIPmtCxlReq/Assgnmt/Assgnr/Agt/FinInstnId/BICFI	SOLADESTXXX
Assignee Agent BIC /Document/FIToFIPmtCxlReq/Assgnmt/Assgne/Agt/FinInstnId/BICFI	MARKDEFFXXX
Creation Date Time /Document/FIToFIPmtCxlReq/Assgnmt/CreDtTm	2019-10-07T15:00:00+00:00
Underying	
Original Message Identification /Document/FIToFIPmtCxlReq/Undrlyg/TxInf/OrgnlGrpInf/OrgnlMsgld	Inp010b007-BAHId
Original Message Name Identification /Document/FIToFIPmtCxlReq/Undrlyg/TxInf/OrgnlGrpInf/OrgnlMsgNmld	pacs.010.001.03
Original End to End Identification /Document/FIToFIPmtCxlReq/Undrlyg/TxInf/OrgnlEndToEndId	Inp010b007-E2EId
Original UETR /Document/FIToFIPmtCxlReq/Undrlyg/TxInf/OrgnlUETR	e010b007-59c5-41e9-be4c-d45102fc201e

Message item	Utilisation
Original Interbank Settlement Amount /Document/FIToFIPmtCxlReq/Undrlyg/TxInf/OrgnlIntrBkSttl mAmt	EUR 470
Original Interbank Settlement Date /Document/FIToFIPmtCxlReq/Undrlyg/TxInf/OrgnlIntrBkSttl mDt	2019-10-09
Code /Document/FIToFIPmtCxlReq/Undrlyg/TxInf/CxIRsnInf/Rsn/ Cd	SYAD

Table 221 - FIToFIPaymentCancellationRequest (camt.056) – usage case Payment Order Revocation Request (Scenario 007)

Usage case example: `Inbound_camt.056_CLM_PaymentCancellationRequest_bs007.xml`

13.2 Credit line management (camt)

13.2.1 ModifyCreditLine (camt.998) - specific for CBs

13.2.1.1 Overview and scope of the message

This chapter illustrates the *ModifyCreditLine* message.

The *ModifyCreditLine* message is sent by a business sender to CLM in order to define, delete or modify the credit line available on the default MCA of a CLM MCA Account Holder.

The *ModifyCreditLine* message can be sent by the following business sender: CB.

The usage of this message is to be found in chapter [Usage of Messages](#) [▶ 324].

In response to the *ModifyCreditLine* message a [Receipt \(camt.025\)](#) [▶ 479] message containing the execution status or business validation error(s) is returned to the business sender.

After successful execution, CLM sends a [BankToCustomerDebitCreditNotification \(camt.054\)](#) [▶ 520] message, if subscribed, confirming the modification of the credit line on the default MCA to the CLM MCA Account Holder.

13.2.1.2 Schema

Outline of the schema

The *ModifyCreditLine* message is composed of the following message building blocks.

MessageHeader

This building block is mandatory and non-repetitive. It must contain an identification assigned by the sending party to uniquely and unambiguously identify the message.

CreditlineIdentification

Identification of the credit line.

NewCreditlineValueSet

This building block is mandatory and non-repetitive.

References/links

The CLM-specific schema and documentation in XSD/Excel/PDF format as well as the message examples are provided outside of this document under the following link:

http://www.swift.com/mystandards/CLM/camt.998.001.03_CLM

Business rules applicable to the schema

For business rules applicable to *ModifyCreditLine* refer to the chapter [Index of validation rules and error codes](#) [▶ 643].

13.2.1.3 The message in business context

Specific message requirements

All content must comply with the business rules for the message.

Message item	Utilisation
Message Header	
Message Identification /Document/PrtryMsg/MsgHdr/MsgId	Value "NONREF" as the message ID is already part of the BAH.
Proprietary Data	
Type /Document/PrtryMsg/PrtryData/Tp	Always "ModifyCreditLine"

Message item	Utilisation
Account Owner /Document/PrtryMsg/PrtryData/Data/T2PrtryData/CrdtLnId/ AcctOwnr	“BIC of the party owning the default MCA account” Credit Line is granted to the default MCA of a CLM Account Holder
Amount with Currency /Document/PrtryMsg/PrtryData/Data/T2PrtryData/NewCrdtLnValSet/AmtWthCcy	New credit line amount. If code "INCR" or "DECR" used, then delta amount. If "RPLC", then new set credit line amount.
Order Type Code /Document/PrtryMsg/PrtryData/Data/T2PrtryData/NewCrdtLnValSet/OrdTpCd	Possible values: <ul style="list-style-type: none"> INCR = Increase, DECR = Decrease, RPLC = Replace. If element is not used, CLM applies "RPLC" as default value.

Table 222 - ModifyCreditLine (camt.998)

Usage case: Credit Line Modification (Scenario 064)

In this usage example, the sending CB is requesting that the credit line applied to the default MCA belonging to account owner (BIC: “SOLADESTXXX”), should be set to EUR 7,500,000. By using an order type of “RPLC” any existing credit line value (or no credit line at all) will be replaced by the value of 7.5 million.

Message item	Utilisation
Message Identification /Document/PrtryMsg/MsgHdr/MsgId	NONREF
Type /Document/PrtryMsg/PrtryData/Tp	ModifyCreditLine

Message item	Utilisation
Account Owner /Document/PrtryMsg/PrtryData/Data/T2PrtryData/CrdtLnId/ AcctOwnr	SOLADESTXXX
Amount with Currency /Document/PrtryMsg/PrtryData/Data/T2PrtryData/NewCrdtLnValSet/AmtWthCcy	EUR 7500000
Order Type Code /Document/PrtryMsg/PrtryData/Data/T2PrtryData/NewCrdtLnValSet/OrdTpCd	RPLC

Table 223 - ModifyCreditLine (camt.998) – usage case Credit Line Modification (Scenario 064)

Usage case example: camt.998_CLM_ModifyCreditLine_RPLC_bs064.xml

Usage case: Credit Line Modification (Scenario 065)

In this usage example, the sending CB is requesting that the credit line applied to the default MCA belonging to account owner (BIC: “SOLADESTXXX”), should be increased by EUR 500,000. By using an order type of “INCR” the existing credit line value will be altered.

Message item	Utilisation
Message Identification /Document/PrtryMsg/MsgHdr/MsgId	NONREF
Type /Document/PrtryMsg/PrtryData/Tp	ModifyCreditLine
Account Owner /Document/PrtryMsg/PrtryData/Data/T2PrtryData/CrdtLnId/ AcctOwnr	SOLADESTXXX
Amount with Currency /Document/PrtryMsg/PrtryData/Data/T2PrtryData/NewCrdtLnValSet/AmtWthCcy	EUR 500000
Order Type Code /Document/PrtryMsg/PrtryData/Data/T2PrtryData/NewCrdtLnValSet/OrdTpCd	INCR

Table 224 - ModifyCreditLine (camt.998) – usage case Credit line modification (Scenario 065)

Usage case example: camt.998_CLM_ModifyCreditLine_INCR_bs065.xml

13.3 Minimum reserve management (camt)

13.3.1 AuthorizePenaltyMinimumReserve (camt.998) - specific for CBs

13.3.1.1 Overview and scope of the message

This chapter illustrates the *AuthorizePenaltyMinimumReserve* message.

The *AuthorizePenaltyMinimumReserve* message is sent by the responsible CB to CLM in order to authorise or to cancel penalties for minimum reserve infringements.

CLM returns a [Receipt \(camt.025\)](#) [▶ 479] message containing either the execution or the respective error code(s) and error description(s) in the case of business validation error(s).

The usage of this message is to be found in chapter [Usage of Messages](#) [▶ 324].

13.3.1.2 Schema

Outline of the schema

The *AuthorizePenaltyMinimumReserve* message is composed of the following message building blocks.

MessageHeader

AuthorizePenaltyMinimumReserveDefinition

References/links

The schema and the related documentation in XSD/Excel/PDF format as well as the message examples are provided within the MyStandards repository under the following link:

http://www.swift.com/mystandards/CLM/camt.998.001.03_CLM

Business rules applicable to the schema

For business rules applicable to *AuthorizePenaltyMinimumReserve* refer to the chapter [Index of validation rules and error codes](#) [▶ 643].

13.3.1.3 The message in business context

Specific message requirements

All content must comply with the business rules for the message.

Message item	Utilisation
Message Header	
Message Identification /Document/PrtryMsg/MsgHdr/MsgId	Value "NONREF" as the message ID is already part of the BAH.
Proprietary Data	
Type /Document/PrtryMsg/PrtryData/Tp	Always "AuthorizePenalty"
T2 Proprietary Data	
Type /Document/PrtryMsg/PrtryData/Data/T2PrtryData/PnltyMgmtId/Tp	penalty management identification BLCK = BLCK
Counterparty Identification BIC /Document/PrtryMsg/PrtryData/Data/T2PrtryData/PnltyMgmtId/CtrPtyId/BIC	BIC of the participant to whom data are referred
New Penalty Value Set	
Maintenance Period From Date /Document/PrtryMsg/PrtryData/Data/T2PrtryData/NewPnltyValSet/MntncPrd/FrDt	Start date of the maintenance period to which data are referred

Message item	Utilisation
Maintenance Period To Date /Document/PrtryMsg/PrtryData/Data/T2PrtryData/NewPnltyValSet/MntncPrd/ToDt	End date of the maintenance period to which data are referred
Penalty Type /Document/PrtryMsg/PrtryData/Data/T2PrtryData/NewPnltyValSet/PnltyTp	Specifies the type of penalty to authorise. It can be: <ul style="list-style-type: none"> "ONE" (penalty for simple infringement) or "TWO" (penalty for repeated infringements). The attribute is mandatory when <PnltySts> is valorised as "PAY".
Penalty Status /Document/PrtryMsg/PrtryData/Data/T2PrtryData/NewPnltyValSet/PnltySts	It must be: "PAY" (for authorising penalty) or "NOPAY" (for cancelling penalty).

Table 225 - AuthorizePenaltyMinimumReserve (camt.998)

Usage case: camt.998 (AuthorisePenalty) is successful (scenario 143)

In this example, a responsible CB is authorising a waiting type ONE minimum reserve penalty for a payment bank (BIC: SOLADESTXXX) relating to the maintenance period of "2020-01-29" to "2020-03-17".

Message item	Utilisation
Message Identification /Document/PrtryMsg/MsgHdr/MsgId	NONREF
Type /Document/PrtryMsg/PrtryData/Tp	AuthorisePenalty
Type /Document/PrtryMsg/PrtryData/Data/T2PrtryData/PnltyMgmtId/Tp	BLCK
Counterparty Identification BIC /Document/PrtryMsg/PrtryData/Data/T2PrtryData/PnltyMgmtId/CtrPtyId/BIC	SOLADESTXXX
Maintenance Period From Date /Document/PrtryMsg/PrtryData/Data/T2PrtryData/NewPnltyValSet/MntncPrd/FrDt	2020-01-29

Message item	Utilisation
Maintenance Period To Date /Document/PrtryMsg/PrtryData/Data/T2PrtryData/NewPnltyValSet/MntncPrd/ToDt	2020-03-17
Penalty Type /Document/PrtryMsg/PrtryData/Data/T2PrtryData/NewPnltyValSet/PnltyTp	ONE
Penalty Status /Document/PrtryMsg/PrtryData/Data/T2PrtryData/NewPnltyValSet/PnltySts	PAY

Table 226 - AuthorisePenaltyMinimumReserve (camt.998) – usage case camt.998 (AuthorisePenalty) is successful (scenario 143)

Usage case example: camt.998_CLM_AuthorisePenaltyMinimumReserve_bs143.xml

Usage case: camt.998 (AuthorisePenalty) fails (scenario 144)

In this example, a responsible CB is authorising a waiting type TWO minimum reserve penalty for a payment bank (BIC: SOLADESTXXX) relating to the maintenance period of “2020-01-30” to “2020-03-17”.

Message item	Utilisation
Message Identification /Document/PrtryMsg/MsgHdr/MsgId	NONREF
Type /Document/PrtryMsg/PrtryData/Tp	AuthorisePenalty
Type /Document/PrtryMsg/PrtryData/Data/T2PrtryData/PnltyMgmtId/Tp	BLCK
Counterparty Identification BIC /Document/PrtryMsg/PrtryData/Data/T2PrtryData/PnltyMgmtId/CtrPtyId/BIC	SOLADESTXXX
Maintenance Period From Date /Document/PrtryMsg/PrtryData/Data/T2PrtryData/NewPnltyValSet/MntncPrd/FrDt	2020-01-30

Message item	Utilisation
Maintenance Period To Date /Document/PrtryMsg/PrtryData/Data/T2PrtryData/NewPnltyValSet/MntncPrd/ToDt	2020-03-17
Penalty Type /Document/PrtryMsg/PrtryData/Data/T2PrtryData/NewPnltyValSet/PnltyTp	TWO
Penalty Status /Document/PrtryMsg/PrtryData/Data/T2PrtryData/NewPnltyValSet/PnltySts	PAY

Table 227 - AuthorisePenaltyMinimumReserve (camt.998) – usage case camt.998 (AuthorisePenalty) fails (scenario 144)

Usage case example: camt.998_CLM_AuthorisePenaltyMinimumReserve_bs144.xml

13.3.2 GetPenaltyMinimumReserve (camt.998) - specific for CBs

13.3.2.1 Overview and scope of the message

This chapter illustrates the *GetPenaltyMinimumReserve* message.

The *GetPenaltyMinimumReserve* message is sent by the responsible CB to CLM to request information about penalties for minimum reserve infringements for its banking community.

This message is replied to by a [ReturnPenaltyMinimumReserve \(camt.998\) - specific for CBs](#) [▶ 591] message.

The usage of this message is to be found in chapter [Usage of Messages](#) [▶ 324].

13.3.2.2 Schema

Outline of the schema

The *GetPenaltyMinimumReserve* message is composed of the following message building blocks.

MessageHeader

GetPenaltyMinimumReserveDefinition

References/links

The schema and the related documentation in XSD/Excel/PDF format as well as the message examples are provided within the MyStandards repository under the following link:

http://www.swift.com/mystandards/CLM/camt.998.001.03_CLM

Business rules applicable to the schema

For business rules applicable to *GetPenaltyMinimumReserve* refer to the chapter [Index of validation rules and error codes](#) [▶ 643].

13.3.2.3 The message in business context

Specific message requirements

All content must comply with the business rules for the message.

Message item	Utilisation
Message Header	
Message Identification /Document/PrtryMsg/MsgHdr/MsgId	Value "NONREF" as the message ID is already part of the BAH.
Proprietary Data	
Type /Document/PrtryMsg/PrtryData/Tp	Always "GetPenalty".
T2 Proprietary Data	
Type /Document/PrtryMsg/PrtryData/Data/T2PrtryData/PnltyMgmtId/Tp	Penalty management identification BLCK = BLCK
Counterparty Identification BIC /Document/PrtryMsg/PrtryData/Data/T2PrtryData/PnltyMgmtId/CtrPtyId/BIC	BIC of the participant to whom data are referred. If not present, data related to all participants of the requesting CB are returned.

Message item	Utilisation
Maintenance Period From Date /Document/PrtryMsg/PrtryData/Data/T2PrtryData/NewPnltyValSet/MntncPrd/FrDt	Start date of the maintenance period to which data are referred. If not present, data related to all maintenance periods are returned.
Maintenance Period To Date /Document/PrtryMsg/PrtryData/Data/T2PrtryData/NewPnltyValSet/MntncPrd/ToDt	End date of the maintenance period to which data are referred. If not present, data related to all maintenance periods are returned.
Penalty Status /Document/PrtryMsg/PrtryData/Data/T2PrtryData/PnltySts	Status of penalty: <ul style="list-style-type: none"> PAY = PAY, NOPAY = NOPAY, WAIT = WAIT.

Table 228 - GetPenaltyMinimumReserve (camt.998)

Usage case: camt.998 (GetPenalty) query with data response (scenario 141)

In this example, a responsible CB is requesting information about minimum reserve penalties for all payment banks in its community and for all penalty status values. The maintenance period in question is “2020-01-29” to “2020-03-17”.

Message item	Utilisation
Message Identification /Document/PrtryMsg/MsgHdr/MsgId	NONREF
Type /Document/PrtryMsg/PrtryData/Tp	GetPenalty
Type /Document/PrtryMsg/PrtryData/Data/T2PrtryData/PnltyMgmtId/Tp	BLCK
Maintenance Period From Date /Document/PrtryMsg/PrtryData/Data/T2PrtryData/NewPnltyValSet/MntncPrd/FrDt	2020-01-29
Maintenance Period To Date /Document/PrtryMsg/PrtryData/Data/T2PrtryData/NewPnltyValSet/MntncPrd/ToDt	2020-03-17

Table 229 - GetPenaltyMinimumReserve (camt.998) – usage case camt.998 (GetPenalty) query with data response (scenario 141)

Usage case example: camt.998_CLM_GetPenaltyMinimumReserve_bs141.xml

Usage case: camt.998 (GetPenalty) query with error response (scenario 142)

In this example, a responsible CB is requesting information about minimum reserve penalties for a specific payment bank (BIC: SOGEFRPPHCM) and for all penalty status values. The maintenance period in question is “2020-01-29” to “2020-03-17”.

Message item	Utilisation
Message Identification /Document/PrtryMsg/MsgHdr/MsgId	NONREF
Type /Document/PrtryMsg/PrtryData/Tp	GetPenalty
Type /Document/PrtryMsg/PrtryData/Data/T2PrtryData/PnltyMgmtId/Tp	BLCK
Counterparty Identification BIC /Document/PrtryMsg/PrtryData/Data/T2PrtryData/PnltyMgmtId/CtrPtyId/BIC	SOGEFRPPHCM
Maintenance Period From Date /Document/PrtryMsg/PrtryData/Data/T2PrtryData/NewPnltyValSet/MntncPrd/FrDt	2020-01-29
Maintenance Period To Date /Document/PrtryMsg/PrtryData/Data/T2PrtryData/NewPnltyValSet/MntncPrd/ToDt	2020-03-17

Table 230 - GetPenaltyMinimumReserve (camt.998) – usage case camt.998 (GetPenalty) query with error response (scenario 142)

Usage case example: camt.998_CLM_GetPenaltyMinimumReserve_bs142.xml

13.3.3 ReturnPenaltyMinimumReserve (camt.998) - specific for CBs

13.3.3.1 Overview and scope of the message

This chapter illustrates the *ReturnPenaltyMinimumReserve* message.

The *ReturnPenaltyMinimumReserve* message is sent by CLM in response to a *GetPenaltyMinimumReserve* message to the responsible CB to return either information about penalties for minimum reserve infringements related to the CB's banking community or respective error code(s) and error description(s) in the case of business validation error(s).

The usage of this message is to be found in chapter [Usage of Messages](#) [▶ 324].

13.3.3.2 Schema

Outline of the schema

The *ReturnPenaltyMinimumReserve* message is composed of the following message building blocks.

MessageHeader

ReturnPenaltyMinimumReserveDefinition

References/links

The schema and the related documentation in XSD/Excel/PDF format as well as the message examples are provided within the MyStandards repository under the following link:

<http://www.swift.com/mystandards/CLM/camt.998.001.03> CLM

Business rules applicable to the schema

No business rules applicable to *ReturnPenaltyMinimumReserve* message.

13.3.3.3 The message in business context

Specific message contents

Message item	Utilisation
Message Header	
Message Identification /Document/PrtryMsg/MsgHdr/MsgId	Value "NONREF" as the message ID is already part of the BAH
Related	
Reference /Document/PrtryMsg/Rltd/Ref	Copy of BAH MsgId of incoming message
Proprietary Data	
Type	Always "ReturnPenalty"

Message item	Utilisation
/Document/PrtryMsg/PrtryData/Tp	
T2 Proprietary Data	
Penalty Report	
Type /Document/PrtryMsg/PrtryData/Data/T2PrtryData/BizRpt/Pn ltyRpt/PnltyMgmtld/Tp	Balance type code for the penalty management identification: BLCK = BLCK, PRAV = PRAV.
Country /Document/PrtryMsg/PrtryData/Data/T2PrtryData/BizRpt/Pn ltyRpt/PnltyMgmtld/Ctry	Country code of the relevant CB
Counterparty ID /Document/PrtryMsg/PrtryData/Data/T2PrtryData/BizRpt/Pn ltyRpt/PnltyMgmtld/CtrPtyld/BIC	Counterparty of the penalty
Maintenance Period From Date /Document/PrtryMsg/PrtryData/Data/T2PrtryData/BizRpt/Pn ltyRpt/MntncPrd/FrDt	Start date of the maintenance period to which data are referred
Maintenance Period To Date /Document/PrtryMsg/PrtryData/Data/T2PrtryData/BizRpt/Pn ltyRpt/MntncPrd/ToDt	End date of the maintenance period to which data are referred
Penalty Status /Document/PrtryMsg/PrtryData/Data/T2PrtryData/BizRpt/Pn ltyRpt/PnltySts	Status of penalty. It can be: "PAY" (authorised); "WAIT" (waiting); "NOPAY" (cancelled). If Penalty Status is not present, data related to all possible status will be returned.
Penalty Type /Document/PrtryMsg/PrtryData/Data/T2PrtryData/BizRpt/Pn ltyRpt/PnltyTp	Specifies the type of penalty to authorise. It can be: "ONE" (penalty for simple infringement) or "TWO" (penalty for repeated infringements). The attribute is mandatory when <PnltySts> is valorised as "PAY".
FirstAmount /Document/PrtryMsg/PrtryData/Data/T2PrtryData/BizRpt/Pn ltyRpt/FirstAmt	Amount of penalty type 1 (penalty for simple infringement)
SecondAmount /Document/PrtryMsg/PrtryData/Data/T2PrtryData/BizRpt/Pn	Amount of penalty type 2 (penalty for repeated infringements)

Message item	Utilisation
ItyRpt/SecondAmt	
Account Report	
Account Identification /Document/PrtryMsg/PrtryData/Data/T2PrtryData/BizRpt/ActRpt/AcctId/BIC	BIC of the participant to whom data are referred
Amount /Document/PrtryMsg/PrtryData/Data/T2PrtryData/BizRpt/ActRpt/Acct/MulBal/Amt	Amount. Depending on the content of the tag <Tp> the amount could refer either to the minimum reserve (<Tp>= BLCK) or to the balance average in the relevant maintenance period (<Tp>= PRAV).
Credit Debit Indicator /Document/PrtryMsg/PrtryData/Data/T2PrtryData/BizRpt/ActRpt/Acct/MulBal/CdtDbtInd	Credit debit indicator: CRDT = CRDT DBIT = DBIT
Type /Document/PrtryMsg/PrtryData/Data/T2PrtryData/BizRpt/ActRpt/Acct/MulBal/Tp	Type of amount. It is: "BLCK" (for minimum reserve) or "PRAV" (progressive average) for the balance average in the relevant maintenance period.
Value Date /Document/PrtryMsg/PrtryData/Data/T2PrtryData/BizRpt/ActRpt/Acct/MulBal/ValDt	Date and time of the response
Operational Error	
Proprietary /Document/PrtryMsg/PrtryData/Data/T2PrtryData/OprlErr/Err/Prtry	Description for validation rule or error code (see Index of validation rules and error codes [643])
Description /Document/PrtryMsg/PrtryData/Data/T2PrtryData/OprlErr/Desc	Description for validation rule or error code (see Index of validation rules and error codes [643])

Table 231 - ReturnPenaltyMinimumReserve (camt.998)

Usage case: camt.998 (GetPenalty) query with data response (scenario 141)

In this example, CLM is responding to the sending CB of a valid Get Penalty (camt.998-GetPenaltyMinimumReserve) message with the data found under the query criteria.

Two payment banks (BICs: COBADEFFXXX and SOLADESTXXX) have been reported with one MCA each (account BICs: COBADEFFXXX and SOLADESTXXX respectively). The first payment bank is due to pay a

penalty of EUR50 for a first settlement failure. The second payment bank is due to pay a penalty of EUR40 for a first settlement failure if it is subsequently authorised.

Message item	Utilisation
Message Identification /Document/PrtryMsg/MsgHdr/MsgId	NONREF
Reference /Document/PrtryMsg/Rltd/Ref	Inc998b141-BAHId
Type /Document/PrtryMsg/PrtryData/Tp	ReturnPenalty
Biz Report block 1	
Penalty Report	
Type /Document/PrtryMsg/PrtryData/Data/T2PrtryData/BizRpt/PnlyRpt/PnlyMgmtId/Tp	BLCK
Country /Document/PrtryMsg/PrtryData/Data/T2PrtryData/BizRpt/PnlyRpt/PnlyMgmtId/Ctry	DE
Counterparty ID /Document/PrtryMsg/PrtryData/Data/T2PrtryData/BizRpt/PnlyRpt/PnlyMgmtId/CtrPtyId/BIC	COBADEFFXXX
Maintenance Period From Date /Document/PrtryMsg/PrtryData/Data/T2PrtryData/BizRpt/PnlyRpt/MntncPrd/FrDt	2020-01-29
Maintenance Period To Date /Document/PrtryMsg/PrtryData/Data/T2PrtryData/BizRpt/PnlyRpt/MntncPrd/ToDt	2020-03-17
Penalty Status /Document/PrtryMsg/PrtryData/Data/T2PrtryData/BizRpt/PnlyRpt/PnlySts	PAY
Penalty Type /Document/PrtryMsg/PrtryData/Data/T2PrtryData/BizRpt/PnlyRpt/PnlyTp	ONE

Message item	Utilisation
FirstAmount /Document/PrtryMsg/PrtryData/Data/T2PrtryData/BizRpt/Pn ltyRpt/FirstAmt	EUR 50
SecondAmount /Document/PrtryMsg/PrtryData/Data/T2PrtryData/BizRpt/Pn ltyRpt/SecondAmt	EUR 500
Account Report	
Account Identification /Document/PrtryMsg/PrtryData/Data/T2PrtryData/BizRpt/Ac ctRpt/AcctId/BIC	COBADEFFXXX
Multi balance block 1	
Amount /Document/PrtryMsg/PrtryData/Data/T2PrtryData/BizRpt/Ac ctRpt/Acct/MulBal/Amt	EUR 8000.00
Credit Debit Indicator /Document/PrtryMsg/PrtryData/Data/T2PrtryData/BizRpt/Ac ctRpt/Acct/MulBal/CdtDbtInd	CRDT
Type /Document/PrtryMsg/PrtryData/Data/T2PrtryData/BizRpt/Ac ctRpt/Acct/MulBal/Tp	BLCK
Value Date /Document/PrtryMsg/PrtryData/Data/T2PrtryData/BizRpt/Ac ctRpt/Acct/MulBal/ValDt	2020-03-23T09:00:00.001+00:00
Multi balance block 2	
Amount /Document/PrtryMsg/PrtryData/Data/T2PrtryData/BizRpt/Ac ctRpt/Acct/MulBal/Amt	EUR 800.00
Credit Debit Indicator /Document/PrtryMsg/PrtryData/Data/T2PrtryData/BizRpt/Ac ctRpt/Acct/MulBal/CdtDbtInd	CRDT
Type /Document/PrtryMsg/PrtryData/Data/T2PrtryData/BizRpt/Ac	PRAV

Message item	Utilisation
ctRpt/Acct/MulBal/Tp	
Value Date	2020-03-23T09:00:00.001+00:00
/Document/PrtryMsg/PrtryData/Data/T2PrtryData/BizRpt/AcctRpt/Acct/MulBal/ValDt	
Biz Report block 2	
Penalty Report	
Type	BLCK
/Document/PrtryMsg/PrtryData/Data/T2PrtryData/BizRpt/PnltyRpt/PnltyMgmtId/Tp	
Country	DE
/Document/PrtryMsg/PrtryData/Data/T2PrtryData/BizRpt/PnltyRpt/PnltyMgmtId/Ctry	
Counterparty ID	SOLADESTXXX
/Document/PrtryMsg/PrtryData/Data/T2PrtryData/BizRpt/PnltyRpt/PnltyMgmtId/CtrPtyId/BIC	
Maintenance Period From Date	2020-01-29
/Document/PrtryMsg/PrtryData/Data/T2PrtryData/BizRpt/PnltyRpt/MntncPrd/FrDt	
Maintenance Period To Date	2020-03-17
/Document/PrtryMsg/PrtryData/Data/T2PrtryData/BizRpt/PnltyRpt/MntncPrd/ToDt	
Penalty Status	WAIT
/Document/PrtryMsg/PrtryData/Data/T2PrtryData/BizRpt/PnltyRpt/PnltySts	
Type	ONE
/Document/PrtryMsg/PrtryData/Data/T2PrtryData/BizRpt/AcctRpt/Acct/MulBal/Tp	
FirstAmount	EUR 40.00
/Document/PrtryMsg/PrtryData/Data/T2PrtryData/BizRpt/PnltyRpt/FirstAmt	
SecondAmount	EUR 400.00
/Document/PrtryMsg/PrtryData/Data/T2PrtryData/BizRpt/PnltyRpt/SecondAmt	

Fehler! Verwenden Sie die Registerkarte 'Start', um dem Text zuzuweisen,

Message item	Utilisation
ItyRpt/SecondAmt	
Account Report	
Account Identification /Document/PrtryMsg/PrtryData/Data/T2PrtryData/BizRpt/AccountRpt/AcctId/BIC	SOLADESTXXX
Multi balance block 1	
Amount /Document/PrtryMsg/PrtryData/Data/T2PrtryData/BizRpt/AccountRpt/Acct/MulBal/Amt	EUR 9000.00
Credit Debit Indicator /Document/PrtryMsg/PrtryData/Data/T2PrtryData/BizRpt/AccountRpt/Acct/MulBal/CdtDbtInd	CRDT
Type /Document/PrtryMsg/PrtryData/Data/T2PrtryData/BizRpt/AccountRpt/Acct/MulBal/Tp	BLCK
Value Date /Document/PrtryMsg/PrtryData/Data/T2PrtryData/BizRpt/AccountRpt/Acct/MulBal/ValDt	2020-03-23T09:00:00.001+00:00
Multi balance block 2	
Amount /Document/PrtryMsg/PrtryData/Data/T2PrtryData/BizRpt/AccountRpt/Acct/MulBal/Amt	EUR 900.00

Message item	Utilisation
Credit Debit Indicator /Document/PrtryMsg/PrtryData/Data/T2PrtryData/BizRpt/AccountRpt/Account/MulBal/CdtDbtInd	CRDT
Type /Document/PrtryMsg/PrtryData/Data/T2PrtryData/BizRpt/AccountRpt/Account/MulBal/Type	PRAV
Value Date /Document/PrtryMsg/PrtryData/Data/T2PrtryData/BizRpt/AccountRpt/Account/MulBal/ValDt	2020-03-23T09:00:00.001+00:00

Table 232 - ReturnPenaltyMinimumReserve (camt.998) – usage case camt.998 (GetPenalty) query with data response (scenario 141)

Usage case example: camt.998_CLM_ReturnPenaltyMinimumReserve_bs141.xml

Usage case: camt.998 (GetPenalty) query with error response (scenario 142)

In this example, CLM is responding to the sending CB of an invalid Get Penalty (camt.998-GetPenaltyMinimumReserve) message with details of the validation error.

The error being informed has a Business Rule code of 'E110', with a description Search criteria not in data scope of business sender.

Message item	Utilisation
Message Identification /Document/PrtryMsg/MsgHdr/MsgId	NONREF
Reference /Document/PrtryMsg/Rltd/Ref	Inc998b142-BAHId
Type /Document/PrtryMsg/PrtryData/Type	ReturnPenalty

Message item	Utilisation
Operational Error	
Proprietary /Document/PrtryMsg/PrtryData/Data/T2PrtryData/OprlErr/Er r/Prtry	E110
Description /Document/PrtryMsg/PrtryData/Data/T2PrtryData/OprlErr/D esc	Search criteria not in data scope of business sender

Table 233 - ReturnPenaltyMinimumReserve (camt.998) – usage case camt.998 (GetPenalty) query with error response (scenario 142)

Usage case example: camt.998_CLM_ReturnPenaltyMinimumReserve_bs142.xml

13.3.4 InsertValueOfReserveMinimumReserve (camt.998) - specific for CBs

13.3.4.1 Overview and scope of the message

This chapter illustrates the *InsertValueOfReserveMinimumReserve* message.

The *InsertValueOfReserveMinimumReserve* message is sent by a CB to CLM to enter the value of the minimum reserve for each credit institution, which is subject to minimum reserve fulfillment.

CLM returns a [Receipt \(camt.025\)](#) [▶ 479] message containing either the execution or the respective error code(s) and error description(s) in the case of business validation error(s).

The usage of this message is to be found in chapter [Usage of Messages](#) [▶ 324].

13.3.4.2 Schema

Outline of the schema

The *InsertValueOfReserveMinimumReserve* message is composed of the following message building blocks.

MessageHeader

InsertValueOfReserveMinimumReserveDefinition

References/links

The schema and the related documentation in XSD/Excel/PDF format as well as the message examples are provided within the MyStandards repository under the following link:

http://www.swift.com/mystandards/CLM/camt.998.001.03_CLM

Business rules applicable to the schema

For business rules applicable to *InsertValueOfReserveMinimumReserve* refer to the chapter [Index of validation rules and error codes](#) [▶ 643].

13.3.4.3 The message in business context

Specific message requirements

All content must comply with the business rules for the message.

Message item	Utilisation
Message Header	
Message Identification /Document/PrtryMsg/MsgHdr/MsgId	Value "NONREF" as the message ID is already part of the BAH
Proprietary Data	
Type /Document/PrtryMsg/PrtryData/Tp	Always "InsertValueOfMinimumReserve".
T2 Proprietary Data	
Minimum Reserve Management Identification	
Type /Document/PrtryMsg/PrtryData/Data/T2PrtryData/MinRsrvMgmtId/Tp	Balance type: BLCK = BLCK
Counterparty Identification /Document/PrtryMsg/PrtryData/Data/T2PrtryData/MinRsrvMgmtId/CtrPtyId/BIC	BIC of the participant to whom data are referred
New Minimum Reserve Value Set	

Message item	Utilisation
Maintenance Period From Date /Document/PrtryMsg/PrtryData/Data/T2PrtryData/NewMinRsrvalSet/MntncPrd/FrDt	Start date of the maintenance period to which data are referred
Maintenance Period To Date /Document/PrtryMsg/PrtryData/Data/T2PrtryData/NewMinRsrvalSet/MntncPrd/ToDt	End date of the maintenance period to which data are referred
Amount /Document/PrtryMsg/PrtryData/Data/T2PrtryData/NewMinRsrvalSet/Amt	Amount of the minimum reserve

Table 234 - InsertValueOfReserveMinimumReserve (camt.998)

Usage case: CLM camt.998 (InsertValue) is successful (Scenario 147)

In this example, a responsible CB is requesting that the minimum reserve requirement for a payment bank (BIC: COBADEFFXXX) relating to the current maintenance period of “2020-03-18” to “2020-05-05”, should be changed to EUR195000.

Message item	Utilisation
Message Identification /Document/PrtryMsg/MsgHdr/MsgId	NONREF
Type /Document/PrtryMsg/PrtryData/Tp	InsertValueOfMinimumReserve
T2 Proprietary Data	
Minimum Reserve Management Identification	
Type /Document/PrtryMsg/PrtryData/Data/T2PrtryData/MinRsrvMgmtld/Tp	BLCK
Counterparty Identification /Document/PrtryMsg/PrtryData/Data/T2PrtryData/MinRsrvMgmtld/CtrPtyId/BIC	COBADEFFXXX
New Minimum Reserve Value Set	

Message item	Utilisation
Maintenance Period From Date /Document/PrtryMsg/PrtryData/Data/T2PrtryData/NewMinRsrVlSet/MntncPrd/FrDt	2020-03-18
Maintenance Period To Date /Document/PrtryMsg/PrtryData/Data/T2PrtryData/NewMinRsrVlSet/MntncPrd/ToDt	2020-05-05
Amount /Document/PrtryMsg/PrtryData/Data/T2PrtryData/NewMinRsrVlSet/Amt	EUR 195000

Table 235 - InsertValueOfMinimumReserve (camt.998) – usage case CLM camt.998 (InsertValue) is successful (Scenario 147)

Usage case example: camt.998_CLM_InsertValueOfMinimumReserve_bs147.xml

Usage case: CLM camt.998 (InsertValue) fails (Scenario 148)

In this example, a responsible CB is requesting that the minimum reserve requirement for a payment bank (BIC: SOLADESTXXX) relating to the current maintenance period of “2019-03-18” to “2019-05-05”, should be changed to EUR190000.

Message item	Utilisation
Message Identification /Document/PrtryMsg/MsgHdr/MsgId	NONREF
Type /Document/PrtryMsg/PrtryData/Tp	InsertValueOfMinimumReserve
T2 Proprietary Data	
Minimum Reserve Management Identification	
Type /Document/PrtryMsg/PrtryData/Data/T2PrtryData/MinRsrvMgmtId/Tp	BLCK
Counterparty Identification /Document/PrtryMsg/PrtryData/Data/T2PrtryData/MinRsrvMgmtId/CtrPtyId/BIC	SOLADESTXXX
New Minimum Reserve Value Set	

Message item	Utilisation
Maintenance Period From Date /Document/PrtryMsg/PrtryData/Data/T2PrtryData/NewMinR srvValSet/MntncPrd/FrDt	2019-03-18
Maintenance Period To Date /Document/PrtryMsg/PrtryData/Data/T2PrtryData/NewMinR srvValSet/MntncPrd/ToDt	2019-05-05
Amount /Document/PrtryMsg/PrtryData/Data/T2PrtryData/NewMinR srvValSet/Amt	EUR 190000

Table 236 - InsertValueOfMinimumReserve (camt.998) – usage case CLM camt.998 (InsertValue) fails (Scenario 148)

Usage case example: camt.998_CLM_InsertValueOfMinimumReserve_bs148.xml

13.3.5 InsertBalanceMinimumReserve (camt.998) - specific for CBs

13.3.5.1 Overview and scope of the message

This chapter illustrates the *InsertBalanceMinimumReserve* message.

The *InsertBalanceMinimumReserve* message is sent by a CB to CLM to send information about the EoD balances of accounts held outside of TARGET Service. The message is also used to adjust the aggregated EoD balance of a CLM Party calculated by CLM.

CLM returns a [Receipt \(camt.025\)](#) [▶ 479] message containing either the execution confirmation or the respective error code(s) and error description(s) in the case of business validation error(s).

The usage of this message is to be found in chapter [Usage of Messages](#) [▶ 324].

13.3.5.2 Schema

Outline of the schema

The *InsertBalanceMinimumReserve* message is composed of the following message building blocks.

MessageHeader

InsertBalanceMinimumReserveDefinition

References/links

The schema and the related documentation in XSD/Excel/PDF format as well as the message examples are provided within the MyStandards repository under the following link:

http://www.swift.com/mystandards/CLM/camt.998.001.03_CLM

Business rules applicable to the schema

For business rules applicable to *InsertBalanceMinimumReserve* refer to the chapter [Index of validation rules and error codes](#) [▶ 643].

13.3.5.3 The message in business context

Specific message requirements

All content must comply with the business rules for the message.

Message item	Utilisation
Message Header	
Message Identification /Document/PrtryMsg/MsgHdr/MsgId	Value "NONREF" as the message ID is already part of the BAH.
Proprietary Data	
Type /Document/PrtryMsg/PrtryData/Tp	Always "InsertBalanceMinimumReserve"
Data	
Country /Document/PrtryMsg/PrtryData/Data/PrtryData/MgmtId/Ctry	Country code of the CB
Number Of Items /Document/PrtryMsg/PrtryData/Data/PrtryData/NbOfItms	Current number of the item A single XML message for each account balance has to be sent. Not used in CLM.
Total Number Of Items /Document/PrtryMsg/PrtryData/Data/PrtryData/TotNbOfItms	Total number of items A single XML message for each account balance has to be sent. Not used in CLM.
Counterparty BIC /Document/PrtryMsg/PrtryData/Data/PrtryData/NewBalValSet/CtrPtyId/BIC	Counterparty identification (CLM Account Holder)

Message item	Utilisation
Amount /Document/PrtryMsg/PrtryData/Data/PrtryData/NewBalValSet/Bal/Amt	Account balance
Credit Debit Indicator /Document/PrtryMsg/PrtryData/Data/PrtryData/NewBalValSet/Bal/CdtDbtInd	Credit debit indicator: CRDT = CRDT, DBIT = DBIT.
Type /Document/PrtryMsg/PrtryData/Data/PrtryData/NewBalValSet/Bal/Tp	Balance type code: CLSG
Value Date /Document/PrtryMsg/PrtryData/Data/PrtryData/NewBalValSet/Bal/ValDt/Dt	Balance value date

Table 237 - InsertBalanceMinimumReserve (camt.998)

Usage case: CLM camt.998 (InsertBalance) is successful (Scenario 149)

In this example, a responsible CB is requesting that the balance of EUR211000 on an external account (BIC: INGBDEFFXXX) relating to the business day of “2020-03-23” should be inserted into CLM records for minimum reserve requirement purposes.

Message item	Utilisation
Message Identification /Document/PrtryMsg/MsgHdr/MsgId	NONREF
Type /Document/PrtryMsg/PrtryData/Tp	InsertBalanceMinimumReserve
Country /Document/PrtryMsg/PrtryData/Data/PrtryData/MgmtId/Ctry	DE
Number Of Items /Document/PrtryMsg/PrtryData/Data/PrtryData/NbOfItms	1
Total Number Of Items /Document/PrtryMsg/PrtryData/Data/PrtryData/TotNbOfItms	1
Counterparty BIC /Document/PrtryMsg/PrtryData/Data/PrtryData/NewBalValSet/Bal/ValDt/Dt	INGBDEFFXXX

Message item	Utilisation
et/CtrPtyId/BIC	
Amount /Document/PrtryMsg/PrtryData/Data/PrtryData/NewBalValSet/Bal/Amt	EUR 211000
Credit Debit Indicator /Document/PrtryMsg/PrtryData/Data/PrtryData/NewBalValSet/Bal/CdtDbtInd	CRDT
Type /Document/PrtryMsg/PrtryData/Data/PrtryData/NewBalValSet/Bal/Tp	CLSG
Value Date /Document/PrtryMsg/PrtryData/Data/PrtryData/NewBalValSet/Bal/ValDt/Dt	2020-03-23

Table 238 - InsertBalanceMinimumReserve (camt.998) – usage case CLM camt.998 (InsertValue) is successful (Scenario 149)

Usage case example: camt.998_CLM_InsertBalanceMinimumReserve_bs149.xml

Usage case: CLM camt.998 (InsertBalance) fails (Scenario 150)

In this example, a responsible CB is requesting that the balance of EUR215000 on an external account (BIC: INGBDEFFXXX) relating to the business day of “2020-03-22” should be inserted into CLM records for minimum reserve requirement purposes.

Message item	Utilisation
Message Identification /Document/PrtryMsg/MsgHdr/MsgId	NONREF
Type /Document/PrtryMsg/PrtryData/Tp	InsertBalanceMinimumReserve
Country /Document/PrtryMsg/PrtryData/Data/PrtryData/MgmtId/Ctry	DE
Number Of Items /Document/PrtryMsg/PrtryData/Data/PrtryData/NbOfItms	1
Total Number Of Items	1

Message item	Utilisation
/Document/PrtryMsg/PrtryData/Data/PrtryData/TotNbOfItms	
Counterparty BIC /Document/PrtryMsg/PrtryData/Data/PrtryData/NewBalValSet/CtrPtyId/BIC	INGBDEFFXXX
Amount /Document/PrtryMsg/PrtryData/Data/PrtryData/NewBalValSet/Bal/Amt	EUR 215000
Credit Debit Indicator /Document/PrtryMsg/PrtryData/Data/PrtryData/NewBalValSet/Bal/CdtDbtInd	CRDT
Type /Document/PrtryMsg/PrtryData/Data/PrtryData/NewBalValSet/Bal/Tp	CLSG
Value Date /Document/PrtryMsg/PrtryData/Data/PrtryData/NewBalValSet/Bal/ValDt/Dt	2020-03-22

Table 239 - InsertBalanceMinimumReserve (camt.998) – usage case CLM camt.998 (InsertValue) fails (Scenario 150)

Usage case example: camt.998_CLM_InsertBalanceMinimumReserve_bs150.xml

13.3.6 ReturnPeriodicInformationMinimumReserve (camt.998) - specific for CBs

13.3.6.1 Overview and scope of the message

This chapter illustrates the *ReturnPeriodicInformationMinimumReserve* message.

The *ReturnPeriodicInformationMinimumReserve* message is sent by CLM in push mode in order to inform the responsible CB about the interest to be paid for the minimum reserve and the penalties for infringements for all members of its banking community, which are subject to minimum reserve fulfillment.

The usage of this message is to be found in chapter [Usage of Messages](#) [▶ 324].

13.3.6.2 Schema

Outline of the schema

The *ReturnPeriodicInformationMinimumReserve* message is composed of the following message building blocks.

MessageHeader

ReturnPeriodicInformationMinimumReserveDefinition

References/links

The schema and the related documentation in XSD/Excel/PDF format as well as the message examples are provided within the MyStandards repository under the following link:

http://www.swift.com/mystandards/CLM/camt.998.001.03_CLM

Business rules applicable to the schema

No business rules applicable to *ReturnPeriodicInformationMinimumReserve* message.

13.3.6.3 The message in business context

Specific message contents

Message item	Utilisation
Message Header	
Message Identification /Document/PrtryMsg/MsgHdr/MsgId	Value "NONREF" as the message ID is already part of the BAH.
Proprietary Data	
Type /Document/PrtryMsg/PrtryData/Tp	Always "ReturnPeriodicInformation"
Proprietary Data	
Country /Document/PrtryMsg/PrtryData/PrtryData/Ctry	Country code of the CB
Maintenance Period FromDate /Document/PrtryMsg/PrtryData/PrtryData/MntncPrd/FrDt	Start date of the maintenance period to which data are referred
Maintenance Period To Date	End date of the maintenance period to which data are

Message item	Utilisation
/Document/PrtryMsg/PrtryData/PrtryData/MntncPrd/ToDt	referred
Report Value Date /Document/PrtryMsg/PrtryData/PrtryData/RptValDt	Settlement date of the interest
Number Of Items /Document/PrtryMsg/PrtryData/PrtryData/NbOfItms	Current number of the item A single XML message for each account balance has to be sent.
Total Number Of Items /Document/PrtryMsg/PrtryData/PrtryData/TotNbOfItms	Total number of items A single XML message for each account balance has to be sent.
Counterparty BIC /Document/PrtryMsg/PrtryData/PrtryData/FlowRpt/CtrPtyId/ BIC	BIC of the CLM actor to whom the data are referred.
Account Report	
Amount /Document/PrtryMsg/PrtryData/PrtryData/FlowRpt/AcctRpt/ Acct/MulBal/Amt	Depending on the content of the tag <Tp> the amount could refer either to the minimum reserve (<Tp>= BLCK) or to the balance average in the relevant maintenance period (<Tp>= PRAV).
Credit Debit Indicator /Document/PrtryMsg/PrtryData/PrtryData/FlowRpt/AcctRpt/ Acct/MulBal/CdtDbtInd	Credit debit indicator. Only Credit will be used. CRDT = CRDT DBIT = DBIT
Type /Document/PrtryMsg/PrtryData/PrtryData/FlowRpt/AcctRpt/ Acct/MulBal/Tp	Type of amount. It will be: "BLCK" (for minimum reserve), "PRAV" (progressive average) for the balance average in the relevant maintenance period, EXRE (for Excess Reserve Exemption (tier1), EXRR (for Excess Reserve Remuneration (tier 2).
Interest Report	
Amount /Document/PrtryMsg/PrtryData/PrtryData/FlowRpt/IntrstRpt/ Amt	Amount of the calculated interests

Message item	Utilisation
Penalty Report	
First Amount /Document/PrtryMsg/PrtryData/PrtryData/FlowRpt/PnltyRpt/ FirstAmt	Use case 1: penalty for simple infringement Use case 2: amount of interest that needs to be paid by the minimum reserve counterparty in the case of a negative interest rate for excess reserve.
Second Amount /Document/PrtryMsg/PrtryData/PrtryData/FlowRpt/PnltyRpt/ SecondAmt	Amount of penalty type 2 (penalty for repeated infringements)

Table 240 - ReturnPeriodicInformationMinimumReserve (camt.998)

Usage case: CLM camt.998 (ReturnPeriodicInformation) is sent to a central bank (Scenario 151)

In this example, a responsible CB receives periodic information on 2020-03-23 relating to the current maintenance period for two of its payment banks.

The first payment bank (BIC: COBADEFFXXX) shows current balances, as well as interest due of EUR60 and penalties currently standing at EUR100 and EUR150 for first and recurrent offences respectively.

The second payment bank (BIC: SOLADESTXXX) shows current balances, as well as interest due of EUR600 but having incurred no penalties in this maintenance period.

Message item	Utilisation
Message Identification /Document/PrtryMsg/MsgHdr/MsgId	NONREF
Type /Document/PrtryMsg/PrtryData/Tp	ReturnPeriodicInformation
Country /Document/PrtryMsg/PrtryData/PrtryData/Ctry	DE
Maintenance Period FromDate /Document/PrtryMsg/PrtryData/PrtryData/MntncPrd/FrDt	2020-03-18
Maintenance Period To Date /Document/PrtryMsg/PrtryData/PrtryData/MntncPrd/ToDt	2020-05-05
Report Value Date /Document/PrtryMsg/PrtryData/PrtryData/RptValDt	2020-03-23
Number Of Items	1

Message item	Utilisation
/Document/PrtryMsg/PrtryData/PrtryData/NbOfItms	
Total Number Of Items	1
/Document/PrtryMsg/PrtryData/PrtryData/TotNbOfItms	
Flow Report block 1	
Counterparty BIC	COBADEFFXXX
/Document/PrtryMsg/PrtryData/PrtryData/FlowRpt/CtrPtyId/ BIC	
Account Report	
Amount	EUR 8000
/Document/PrtryMsg/PrtryData/PrtryData/FlowRpt/AcctRpt/ Acct/MulBal/Amt	
Credit Debit Indicator	CRDT
/Document/PrtryMsg/PrtryData/PrtryData/FlowRpt/AcctRpt/ Acct/MulBal/CdtDbtInd	
Type	BLCK
/Document/PrtryMsg/PrtryData/PrtryData/FlowRpt/AcctRpt/ Acct/MulBal/Tp	
Amount	EUR 800
/Document/PrtryMsg/PrtryData/PrtryData/FlowRpt/AcctRpt/ Acct/MulBal/Amt	
Credit Debit Indicator	CRDT
/Document/PrtryMsg/PrtryData/PrtryData/FlowRpt/AcctRpt/ Acct/MulBal/CdtDbtInd	
Type	PRAV
/Document/PrtryMsg/PrtryData/PrtryData/FlowRpt/AcctRpt/ Acct/MulBal/Tp	
Amount	EUR 56000.00
/Document/PrtryMsg/PrtryData/PrtryData/Flow Rpt/AcctRpt/ Acct/MulBal/Amt	
Credit Debit Indicator	CRDT
/Document/PrtryMsg/PrtryData/PrtryData/Flow Rpt/AcctRpt/ Acct/MulBal/CdtDbtInd	

Message item	Utilisation
Type /Document/PrtryMsg/PrtryData/PrtryData/Flow Rpt/AcctRpt/ Acct/MulBal/Tp	EXRE
Amount /Document/PrtryMsg/PrtryData/PrtryData/Flow Rpt/AcctRpt/ Acct/MulBal/Amt	EUR 0
Credit Debit Indicator /Document/PrtryMsg/PrtryData/PrtryData/Flow Rpt/AcctRpt/ Acct/MulBal/CdtDbtInd	CRDT
Type /Document/PrtryMsg/PrtryData/PrtryData/Flow Rpt/AcctRpt/ Acct/MulBal/Tp	EXRR
Interest Report	
Amount /Document/PrtryMsg/PrtryData/PrtryData/FlowRpt/IntrstRpt/ Amt	EUR 60.00
Penalty Report	
First Amount /Document/PrtryMsg/PrtryData/PrtryData/FlowRpt/PnltyRpt/ FirstAmt	EUR 100
Second Amount /Document/PrtryMsg/PrtryData/PrtryData/FlowRpt/PnltyRpt/ SecondAmt	EUR 150
Flow Report block 2	
Counterparty BIC /Document/PrtryMsg/PrtryData/PrtryData/FlowRpt/CtrPtyId/ BIC	SOLADESTXXX
Account Report	
Amount /Document/PrtryMsg/PrtryData/PrtryData/FlowRpt/AcctRpt/ Acct/MulBal/Amt	EUR 9000
Credit Debit Indicator	CRDT

Fehler! Verwenden Sie die Registerkarte 'Start', um dem Text zuzuweisen,

Message item	Utilisation
/Document/PrtryMsg/PrtryData/PrtryData/FlowRpt/AcctRpt/Acct/MulBal/CdtDbtInd	
Type	BLCK
/Document/PrtryMsg/PrtryData/PrtryData/FlowRpt/AcctRpt/Acct/MulBal/Tp	
Amount	EUR 9000
/Document/PrtryMsg/PrtryData/PrtryData/FlowRpt/AcctRpt/Acct/MulBal/Amt	
Credit Debit Indicator	CRDT
/Document/PrtryMsg/PrtryData/PrtryData/FlowRpt/AcctRpt/Acct/MulBal/CdtDbtInd	
Type	PRAV
/Document/PrtryMsg/PrtryData/PrtryData/FlowRpt/AcctRpt/Acct/MulBal/Tp	
Amount	EUR 63000
/Document/PrtryMsg/PrtryData/PrtryData/Flow Rpt/AcctRpt/Acct/MulBal/Amt	
Credit Debit Indicator	CRDT
/Document/PrtryMsg/PrtryData/PrtryData/Flow Rpt/AcctRpt/Acct/MulBal/CdtDbtInd	
Type	EXRE
/Document/PrtryMsg/PrtryData/PrtryData/Flow Rpt/AcctRpt/Acct/MulBal/Tp	
Amount	EUR 0
/Document/PrtryMsg/PrtryData/PrtryData/Flow Rpt/AcctRpt/Acct/MulBal/Amt	
Credit Debit Indicator	CRDT
/Document/PrtryMsg/PrtryData/PrtryData/Flow Rpt/AcctRpt/Acct/MulBal/CdtDbtInd	

Message item	Utilisation
Type /Document/PrtryMsg/PrtryData/PrtryData/Flow Rpt/AcctRpt/ Acct/MulBal/Tp	EXRR
Interest Report	
Amount /Document/PrtryMsg/PrtryData/PrtryData/Flow Rpt/IntrstRpt/ Amt	EUR 600

Table 241 - ReturnPeriodicInformationMinimumReserve (camt.998) – usage case CLM camt.998 (ReturnPeriodicInformation) is sent to a central bank (Scenario 151)

Usage case example: camt.998_CLM_ReturnPeriodicInformationMinimumReserve_bs151.xml

13.4 Payments clearing and settlement (pacs)

13.4.1 PaymentStatusReport (pacs.002)

13.4.1.1 Overview and scope of the message

This chapter illustrates the *PaymentStatusReport* message.

The *PaymentStatusReport* message is sent by CLM to the business sender of an inbound payment message. It is used to inform the business sender about the status of the previous payment order.

The *PaymentStatusReport* message is treated as mandatory for all processing failures. To receive a *PaymentStatusReport* message for successful processing, message subscription is required.

The usage of this message is to be found in chapter [Usage of Messages](#) [▶ 324].

The *PaymentStatusReport* message is sent in response to a previously sent payment order message ([FinancialInstitutionCreditTransfer \(pacs.009\)](#) [▶ 624] or [FinancialInstitutionDirectDebit \(pacs.010\)](#) [▶ 633]).

13.4.1.2 Schema

Outline of the schema

The *PaymentStatusReport* message is composed of the following message building blocks.

GroupHeader

This building block is mandatory and non-repetitive. The identification by the business sender to uniquely and unambiguously identify the message is part of the BAH, therefore the content of message ID is "NONREF".

TransactionInformationAndStatus

This building block is mandatory and non-repetitive. It provides information concerning the original transactions, to which the status report message refers. It may contain:

- | original group information;
- | original instruction identification;
- | original UETR;
- | status;
- | status reason information block/s (see below);
- | CLM reference.

StatusReasonInformation

This building block is optional and repetitive. Each repetition provides a different reason in support of the status. For example, there may be multiple validation errors which lead to a rejection.

References/links

The CLM-specific schema and documentation in XSD/Excel/PDF format as well as the message examples are provided outside of this document under the following link:

http://www.swift.com/mystandards/CLM/pacs.002.001.10_CLM

Business rules applicable to the schema

No business rules are applicable to a *FIToFIPaymentStatusReport* message.

13.4.1.3 The message in business context

Specific message contents

Message item	Utilisation
Group Header	
Message Identification /Document/FIToFIPmtStsRpt/GrpHdr/MsgId	Value "NONREF" as the message ID is already part of the BAH.
Creation Date Time /Document/FIToFIPmtStsRpt/GrpHdr/CreDtTm	Date and time at which the message was created

Message item	Utilisation
Transaction Information And Status	
Original Group Information	
Original Message Identification /Document/FIToFIPmtStsRpt/TxInfAndSts/OrgnlGrpInf/OrgnlMsgld	Copy of the BizMsgldr used in the BAH of the original payment sent to CLM.
Original Message Name Identification /Document/FIToFIPmtStsRpt/TxInfAndSts/OrgnlGrpInf/OrgnlMsgNmld	Copy of the MsgDefldr used in the BAH of the original payment sent to CLM.
Original Instruction Identification /Document/FIToFIPmtStsRpt/TxInfAndSts/OrgnlInstrld	Copy of the Instruction identification used in the original payment sent to CLM
Original End To End Identification /Document/FIToFIPmtStsRpt/TxInfAndSts/OrgnlEndToEndld	Copy of the end-to-end identification used in the original payment sent to CLM
Original UETR /Document/FIToFIPmtStsRpt/TxInfAndSts/OrgnlUETR	Copy of the UETR used in the original payment sent to CLM.
Transaction Status /Document/FIToFIPmtStsRpt/TxInfAndSts/TxSts	Specifies the status of a transaction as: <ul style="list-style-type: none"> ACSC = Accepted settlement completed, RJCT = Rejected.
Status Reason Information /Document/FIToFIPmtStsRpt/TxInfAndSts/StsRsnInf/Rsn/Prttry	CLM rejection reason code
Additional Information /Document/FIToFIPmtStsRpt/TxInfAndSts/StsRsnInf/AddtlInf	Detailed error description
Effective Interbank Settlement Date /Document/FIToFIPmtStsRpt/TxInfAndSts/FctvIntrBkSttlmDt/DtTm	Settlement time stamp of the original payment sent to CLM. Used only if Transaction Status code is equal to 'ACSC'.
Clearing System Reference /Document/FIToFIPmtStsRpt/TxInfAndSts/ClrSysRef	CLM booking reference for the payment assigned by CLM

Table 242 - PaymentStatusReport (pacs.002)

Usage case: Payment Order Rejection Notification (Scenario 001)

In this usage example, CLM is advising the business sender (CB) of a previous pacs.009 message that has been rejected by CLM validation. The failing reason code is “E017” (beyond warehousing period) and the appropriate text for this error is also included. The previous pacs.009 can be identified using the pacs.009 BAH BizMsgldr and the business sender’s references of instruction identification and UETR which are also supplied on the *pacs.002*.

Message item	Utilisation
Group Header	
Message Identification /Document/FIToFIPmtStsRpt/GrpHdr/Msgld	NONREF
Creation Date Time /Document/FIToFIPmtStsRpt/GrpHdr/CreDtTm	2019-10-07T17:36:00.001+00:00
Transaction Information And Status	
Original Group Information	
Original Message Identification /Document/FIToFIPmtStsRpt/TxInfAndSts/OrgnlGrplnf/OrgnlMsgld	Inp009b001-BAHId
Original Message Name Identification /Document/FIToFIPmtStsRpt/TxInfAndSts/OrgnlGrplnf/OrgnlMsgNmld	pacs.009.001.08
Original Instruction Identification /Document/FIToFIPmtStsRpt/TxInfAndSts/OrgnlInstrld	Inp009b001-InslId
Original End To End Identification /Document/FIToFIPmtStsRpt/TxInfAndSts/OrgnlEndToEndId	Inp009b001-E2EId
Original UETR /Document/FIToFIPmtStsRpt/TxInfAndSts/OrgnlUETR	e009b001-59c5-41e9-be4c-d45102fc201e

Message item	Utilisation
Transaction Status /Document/FIToFIPmtStsRpt/TxInfAndSts/TxSts	RJCT
Status Reason Information /Document/FIToFIPmtStsRpt/TxInfAndSts/StsRsnInf/Rsn/P rtry	E017
Additional Information /Document/FIToFIPmtStsRpt/TxInfAndSts/StsRsnInf/Addtll nf	Settlement date greater than latest submission date for warehoused payments or not a valid business day.

Table 243 - PaymentStatusReport (pacs.002) – usage case Payment Order Rejection Notification (Scenario 001)

Usage case example: pacs.002_CLM_FIPaymentStatusReport_RJCT_bs001.xml

Usage case: Payment Order Rejection Notification (Scenario 005)

In this usage example, CLM is advising the business sender (CB) of a previous pacs.010 message that has been rejected by CLM validation. The failing reason code is “E017” (beyond warehousing period) and the appropriate text for this error is also included. The previous pacs.010 can be identified using the pacs.010 BAH BizMsgldr and the business sender’s references of instruction identification and UETR which are also supplied on the pacs.002.

Message item	Utilisation
Group Header	
Message Identification /Document/FIToFIPmtStsRpt/GrpHdr/Msgld	NONREF
Creation Date Time /Document/FIToFIPmtStsRpt/GrpHdr/CreDtTm	2019-10-07T17:36:00.001+00:00
Transaction Information And Status	
Original Group Information	
Original Message Identification /Document/FIToFIPmtStsRpt/TxInfAndSts/OrgnlGrplnf/Org nlMsgld	Inp010b005-BAHId
Original Message Name Identification /Document/FIToFIPmtStsRpt/TxInfAndSts/OrgnlGrplnf/Org nlMsgNmId	pacs.010.001.03
Original Instruction Identification	Inp010b005-InsId

Message item	Utilisation
/Document/FIToFIPmtStsRpt/TxInfAndSts/OrgnlInstrId	
Original End To End Identification	Inp009b005-E2EId
/Document/FIToFIPmtStsRpt/TxInfAndSts/OrgnlEndToEndId	
Original UETR	e010b005-59c5-41e9-be4c-d45102fc201e
/Document/FIToFIPmtStsRpt/TxInfAndSts/OrgnlUETR	
Transaction Status	RJCT
/Document/FIToFIPmtStsRpt/TxInfAndSts/TxSts	
Status Reason Information	E017
/Document/FIToFIPmtStsRpt/TxInfAndSts/StsRsnInf/Rsn/Prtry	
Additional Information	Settlement date greater than latest submission date for warehoused payments or not a valid business day
/Document/FIToFIPmtStsRpt/TxInfAndSts/StsRsnInf/AddtlInf	

Table 244 - PaymentStatusReport (pacs.002) – usage case Payment Order Rejection Notification (Scenario 005)

Usage case example: pacs.002_CLM_FIPaymentStatusReport_RJCT_bs005.xml

Usage case: Payment Order Settlement Notification (Connected Payment) (Scenario 002)

In this usage example, CLM is advising the business sender (CB) of a previous pacs.009 message that has been settled by CLM. The CLM system reference and settlement time are also given. The previous pacs.009 can be identified using the pacs.009 BAH BizMsgIdr and the business sender's references of Instruction identification and UETR which are also supplied on the pacs.002.

Message item	Utilisation
Group Header	
Message Identification	NONREF
/Document/FIToFIPmtStsRpt/GrpHdr/MsgId	
Creation Date Time	2019-10-08T09:42:30.001+00:00
/Document/FIToFIPmtStsRpt/GrpHdr/CreDtTm	
Transaction Information And Status	
Original Group Information	
Original Message Identification	Inp009b002-BAHId

Message item	Utilisation
/Document/FIToFIPmtStsRpt/TxInfAndSts/OrgnlGrpInf/OrgnlMsgld	
Original Message Name Identification /Document/FIToFIPmtStsRpt/TxInfAndSts/OrgnlGrpInf/OrgnlMsgNmld	pacs.009.001.08
Original Instruction Identification /Document/FIToFIPmtStsRpt/TxInfAndSts/OrgnlInstrld	Inp009b002-Insld
Original End To End Identification /Document/FIToFIPmtStsRpt/TxInfAndSts/OrgnlEndToEndld	Inp009b002-E2Eld
Original UETR /Document/FIToFIPmtStsRpt/TxInfAndSts/OrgnlUETR	e009b002-59c5-41e9-be4c-d45102fc201e
Transaction Status /Document/FIToFIPmtStsRpt/TxInfAndSts/TxSts	ACSC
Effective Interbank Settlement Date /Document/FIToFIPmtStsRpt/TxInfAndSts/FctvIntrBkSttlmDt/DtTm	2019-10-08T09:42:25.001+00:00
Clearing System Reference /Document/FIToFIPmtStsRpt/TxInfAndSts/ClrSysRef	CLM-p009b002

Table 245 - PaymentStatusReport (pacs.002) – usage case Payment Order Settlement Notification (Connected Payment) (Scenario 002)

Usage case example: pacs.002_CLM_FIPaymentStatusReport_ACSC_bs002.xml

Usage case: Payment Order Revocation Notification (Scenario 003)

In this usage example, CLM is advising the business sender (CB) of a previous pacs.009 message that has been rejected by CLM. The failing reason code is “E067” (payment revoked) and the appropriate text for this error is also included. The previous pacs.009 can be identified using the pacs.009 BAH BizMsgldr and the business sender’s references of Instruction identification and UETR which are also supplied on the pacs.002.

Message item	Utilisation
Group Header	
Message Identification /Document/FIToFIPmtStsRpt/GrpHdr/Msgld	NONREF

Message item	Utilisation
Creation Date Time /Document/FIToFIPmtStsRpt/GrpHdr/CreDtTm	2019-10-07T15:01:00.001+00:00
Transaction Information And Status	
Original Group Information	
Original Message Identification /Document/FIToFIPmtStsRpt/TxInfAndSts/OrgnlGrplnf/OrgnlMsgld	Inp009b003-BAHId
Original Message Name Identification /Document/FIToFIPmtStsRpt/TxInfAndSts/OrgnlGrplnf/OrgnlMsgNmld	pacs.009.001.08
Original Instruction Identification /Document/FIToFIPmtStsRpt/TxInfAndSts/OrgnlInstrld	Inp009b003-Insld
Original End To End Identification /Document/FIToFIPmtStsRpt/TxInfAndSts/OrgnlEndToEndld	Inp009b003-E2Eld
Original UETR /Document/FIToFIPmtStsRpt/TxInfAndSts/OrgnlUETR	e009b003-59c5-41e9-be4c-d45102fc201e
Transaction Status /Document/FIToFIPmtStsRpt/TxInfAndSts/TxSts	RJCT
Status Reason Information /Document/FIToFIPmtStsRpt/TxInfAndSts/StsRsnInf/Rsn/Prtry	E067
Additional Information /Document/FIToFIPmtStsRpt/TxInfAndSts/StsRsnInf/AddtlInf	Payment order revoked

Table 246 - PaymentStatusReport (pacs.002) – usage case Payment Order Revocation Notification (Scenario 003)

Usage case example: pacs.002_CLM_FIPaymentStatusReport_RJCT_bs003.xml

Usage case: Payment Order Settlement Notification (Standard CLM Settlement) (Scenario 004)

In this usage example, CLM is advising the business sender (CB) of a previous pacs.009 message that has been settled by CLM. The CLM system reference and settlement time are also given. The previous pacs.009

can be identified using the pacs.009 BAH BizMsgldr and the business sender's references of Instruction identification and UETR which are also supplied on the pacs.002.

Message item	Utilisation
Group Header	
Message Identification /Document/FIToFIPmtStsRpt/GrpHdr/Msgld	NONREF
Creation Date Time /Document/FIToFIPmtStsRpt/GrpHdr/CreDtTm	2019-10-09T07:25:01.001+00:00
Transaction Information And Status	
Original Group Information	
Original Message Identification /Document/FIToFIPmtStsRpt/TxInfAndSts/OrgnlGrpInf/OrgnlMsgld	Inp009b004-BAHId
Original Message Name Identification /Document/FIToFIPmtStsRpt/TxInfAndSts/OrgnlGrpInf/OrgnlMsgNmld	pacs.009.001.08
Original Instruction Identification /Document/FIToFIPmtStsRpt/TxInfAndSts/OrgnlInstrld	Inp009b004-Insld
Original End To End Identification /Document/FIToFIPmtStsRpt/TxInfAndSts/OrgnlEndToEndld	Inp009b004-E2Eld
Original UETR /Document/FIToFIPmtStsRpt/TxInfAndSts/OrgnlUETR	e009b004-59c5-41e9-be4c-d45102fc201e
Transaction Status /Document/FIToFIPmtStsRpt/TxInfAndSts/TxSts	ACSC
Effective Interbank Settlement Date /Document/FIToFIPmtStsRpt/TxInfAndSts/FctvIntrBkSttlmDtDtTm	2019-10-09T07:25:00.001+00:00
Clearing System Reference /Document/FIToFIPmtStsRpt/TxInfAndSts/ClrSysRef	CLM-p009b004

Table 247 - PaymentStatusReport (pacs.002) – usage case Payment Order Settlement Notification (Standard CLM Settlement) (Scenario 004)

Usage case example: pacs.002_CLM_FIPaymentStatusReport_ACSC_bs004.xml

13.4.2 FinancialInstitutionCreditTransfer (pacs.009)

13.4.2.1 Overview and scope of the message

This chapter illustrates the *FinancialInstitutionCreditTransfer* message.

This message type is used in CLM to execute a payment between two CLM Accounts.

The payment message can be sent by the following business sender:

- l CB.

The credited and debited CLM Accounts must be denominated in the same currency.

The usage of this message is to be found in chapter [Usage of Messages](#) [▶ 324].

In response to the *FinancialInstitutionCreditTransfer* message, a [PaymentStatusReport \(pacs.002\)](#) [▶ 615] message containing the status of the payment order may be returned to the business sender.

In addition, if the payment order is successfully settled, the *FinancialInstitutionCreditTransfer* message is not forwarded to the business receiver of the credited CLM Account. A [BankToCustomerDebitCreditNotification \(camt.054\)](#) [▶ 520] will be sent to the business receiver of the credited CLM Account if they have subscribed to receive it.

13.4.2.2 Schema

Outline of the schema

The *FinancialInstitutionCreditTransfer* message is composed of the following message building blocks.

GroupHeader

This building block is mandatory and non-repetitive. The identification by the business sender to uniquely and unambiguously identify the message is part of the BAH, therefore the content of message ID is "NONREF".

CreditTransferTransactionInformation

Set of elements providing information specific to the transaction and relevant for settlement in CLM.

- l payment identification;
- l payment type;
- l interbank settlement amount;
- l interbank settlement date;

- | settlement time indication and request;
- | instructing and instructed agent.

References/links

The CLM specific schema and documentation in XSD/Excel/PDF format as well as the message examples are provided outside of this document under the following link:

http://www.swift.com/mystandards/CLM/pacs.009.001.08_CLM

Business rules applicable to the schema

When used in its inbound form, for business rules applicable to *FinancialInstitutionCreditTransfer* refer to the chapter [Index of validation rules and error codes](#) [▶ 643].

13.4.2.3 The message in business context

Specific message requirements

All content must comply with the business rules for the message.

Message item	Utilisation
Group Header	
Message Identification /Document/FICdtTrf/GrpHdr/MsgId	Value "NONREF" as the message ID is already part of the BAH
Creation Date Time /Document/FICdtTrf/GrpHdr/CreDtTm	Date and time at which the message was created.
Number Of Transactions /Document/FICdtTrf/GrpHdr/NbOfTx	Only "1" is allowed
Settlement Method /Document FICdtTrf/GrpHdr/SttlmInf/SttlmMtd	Only "CLRG" is allowed
Clearing System Code /Document/FICdtTrf/GrpHdr/SttlmInf/ClrSys/Cd	Only "TGT" is allowed
Credit Transfer Transaction Information	
Payment Identification	
Instruction Identification /Document/FICdtTrf/CdtTrfTxInf/PmtId/InstrId	It is ignored by CLM

Message item	Utilisation
End To End Identification /Document/FICdtTrf/CdtTrfTxInf/PmtId/EndToEndId	It is ignored by CLM
UETR /Document/FICdtTrf/CdtTrfTxInf/PmtId/UETR	Universally unique identifier to provide an end-to-end reference of a payment transaction.
Payment Type Information	
Local Instrument Code /Document/FICdtTrf/CdtTrfTxInf/PmtTpInf/LclInstrm/Cd	It is ignored by CLM
Local Instrument Proprietary /Document/FICdtTrf/CdtTrfTxInf/PmtTpInf/LclInstrm/Prtry	A payment by a CB to a CLM Account Holder that triggers both a decrease of the credit line on the MCA of the CLM Account Holder and an immediate credit of its account to compensate the change in the credit line. CONP = Connected Payment Format: CONP/Amount Credit line change amount to be provided as delta amount.
Interbank Settlement Amount Document/FICdtTrf/CdtTrfTxInf/IntrBkSttlmAmt	Amount relevant for settlement in CLM
Interbank Settlement Date Document/FICdtTrf/CdtTrfTxInf/IntrBkSttlmDt	Date relevant for settlement in CLM. CLM only accepts the current business date, or a future business date as allowed by the CLM warehoused payment period parameter. If the settlement date is not a CLM business day for the indicated currency the payment order will be rejected immediately.
Settlement Time Request	
From Time /Document/FICdtTrf/CdtTrfTxInf/SttlmTmReq/FrTm	Used to set an earliest execution time. Must be before the cut-off time for interbank payments.
Reject Time /Document/FICdtTrf/CdtTrfTxInf/SttlmTmReq/RjctTm	Used to set a latest execution time. Must be before the cut-off time for interbank payments. If reject time is reached and settlement could not take place, the payment order will be rejected.
Payment Parties	
Instructing Agent BIC	BIC of the CLM cash account to be debited

Message item	Utilisation
/Document/FICdtTrf/CdtTrfTxInf/InstgAgt/FinInstnId/BICFI	
Instructed Agent BIC	BIC of the CLM cash account to be credited
/Document/FICdtTrf/CdtTrfTxInf/InstdAgt/FinInstnId/BICFI	
Debtor	Mandatory but not relevant for settlement of a payment in CLM. BIC is subject to BIC validation.
/Document/FICdtTrf/CdtTrfTxInf/Dbtr/FinInstnId/BICFI	
Creditor	Mandatory but not relevant for settlement of a payment in CLM. BIC is subject to BIC validation.
/Document/FICdtTrf/CdtTrfTxInf/Cdtr/FinInstnId/BICFI	
Remittance Information	If provided it is ignored by CLM
/Document/FICdtTrf/CdtTrfTxInf/RmtInf/Ustrd	

Table 248 - FinancialInstitutionCreditTransfer (pacs.009)

Usage case: Financial Institution Credit Transfer Order (Scenario 001)

In this usage example, the business sender (CB) has requested the movement of EUR 85,000 from its account (with BIC “MARKDEFFXXX”) to a PB MCA (with BIC “SOLADESTXXX”) to be warehoused until 27 October 2019. The message was created and sent on 7 October, therefore it is expected that this will fail validation because it is beyond the maximum warehousing period.

Message item	Utilisation
Group Header	
Message Identification	NONREF
/Document/FICdtTrf/GrpHdr/MsgId	
Creation Date Time	2019-10-07T17:35:00+00:00
/Document/FICdtTrf/GrpHdr/CreDtTm	
Number Of Transactions	1
/Document/FICdtTrf/GrpHdr/NbOfTxs	
Settlement Method	CLRG
/Document FICdtTrf/GrpHdr/SttlmInf/SttlmMtd	
Clearing System Code	TGT
/Document/FICdtTrf/GrpHdr/SttlmInf/ClrSys/Cd	
Credit Transfer Transaction Information	
Payment Identification	

Message item	Utilisation
Instruction Identification /Document/FICdtTrf/CdtTrfTxInf/PmtId/InstrId	Inp009b001-InsId
End To End Identification /Document/FICdtTrf/CdtTrfTxInf/PmtId/EndToEndId	Inp009b001-E2EId
UETR /Document/FICdtTrf/CdtTrfTxInf/PmtId/UETR	e009b001-59c5-41e9-be4c-d45102fc201e
Payment Type Information	
Interbank Settlement Amount Document/FICdtTrf/CdtTrfTxInf/IntrBkSttlmAmt	EUR 85000
Interbank Settlement Date Document/FICdtTrf/CdtTrfTxInf/IntrBkSttlmDt	2019-10-27
Payment Parties	
Instructing Agent BIC /Document/FICdtTrf/CdtTrfTxInf/InstgAgt/FinInstnId/BICFI	MARKDEFFXXX
Instructed Agent BIC /Document/FICdtTrf/CdtTrfTxInf/InstdAgt/FinInstnId/BICFI	SOLADESTXXX
Debtor /Document/FICdtTrf/CdtTrfTxInf/Dbtr/FinInstnId/BICFI	MARKDEFFXXX
Creditor /Document/FICdtTrf/CdtTrfTxInf/Cdtr/FinInstnId/BICFI	SOLADESTXXX

Table 249 - FICreditTransfer (pacs.009) – usage case Financial Institution Credit Transfer Order (Scenario 001)

Usage case example: Inbound_pacs.009_CLM_FICreditTransferOrder_bs001.xml

Usage case: Financial Institution Credit Transfer Order (Scenario 002)

In this usage example, the business sender (CB) has requested a decrease of the credit line granted to the CLM default MCA (with BIC “SOLADESTXXX”) by a value of EUR 100,000. The expectation is that this payment order will be settled immediately (i.e. no queueing), with the subsequent creation of a [PaymentStatusReport \(pacs.002\)](#) [▶ 615], [BankToCustomerDebitCreditNotification \(camt.054\)](#) [▶ 520], and relevant entries in the [BankToCustomerStatement \(camt.053\)](#) [▶ 511] for the 8 October business day.

Message item	Utilisation
Group Header	
Message Identification /Document/FICdtTrf/GrpHdr/MsgId	NONREF
Creation Date Time /Document/FICdtTrf/GrpHdr/CreDtTm	2019-10-08T09:41:00+00:00
Number Of Transactions /Document/FICdtTrf/GrpHdr/NbOfTx	1
Settlement Method /Document FICdtTrf/GrpHdr/SttlmInf/SttlmMtd	CLRG
Clearing System Code /Document/FICdtTrf/GrpHdr/SttlmInf/ClrSys/Cd	TGT
Credit Transfer Transaction Information	
Payment Identification	
Instruction Identification /Document/FICdtTrf/CdtTrfTxInf/PmtId/InstrId	Inp009b002-InsId
End To End Identification /Document/FICdtTrf/CdtTrfTxInf/PmtId/EndToEndId	Inp009b002-E2EId
UETR /Document/FICdtTrf/CdtTrfTxInf/PmtId/UETR	e009b002-59c5-41e9-be4c-d45102fc201e
Payment Type Information	
Local Instrument Proprietary /Document/FICdtTrf/CdtTrfTxInf/PmtTpInf/LclInstrm/Prtry	CONP/100000.00
Interbank Settlement Amount Document/FICdtTrf/CdtTrfTxInf/IntrBkSttlmAmt	EUR 0
Interbank Settlement Date Document/FICdtTrf/CdtTrfTxInf/IntrBkSttlmDt	2019-10-08
Payment Parties	
Instructing Agent BIC /Document/FICdtTrf/CdtTrfTxInf/InstgAgt/FinInstnId/BICFI	MARKDEFFXXX

Message item	Utilisation
Instructed Agent BIC /Document/FICdtTrf/CdtTrfTxInf/InstdAgt/FinInstnId/BICFI	SOLADESTXXX
Debtor /Document/FICdtTrf/CdtTrfTxInf/Dbtr/FinInstnId/BICFI	MARKDEFFXXX
Creditor /Document/FICdtTrf/CdtTrfTxInf/Cdtr/FinInstnId/BICFI	SOLADESTXXX

Table 250 - FICreditTransferOrder (pacs.009) – usage case Financial Institution Credit Transfer Order (Scenario 002)

Usage case example: Inbound_pacs.009_CLM_FICreditTransferOrder_CONP_bs002.xml

Usage case: Financial Institution Credit Transfer Order (Scenario 003)

In this usage example, the business sender (CB) has requested the movement of EUR 450,000 from its account (with BIC “MARKDEFFXXX”) to a PB MCA (with BIC “SOLADESTXXX”) with a settlement date of 8th October 2019. The message was created and sent on 7 October at 14:15 CET with a settlement date of 8 October. Therefore, it is expected that this payment will be warehoused until the following day.

Message item	Utilisation
Group Header	
Message Identification /Document/FICdtTrf/GrpHdr/MsgId	NONREF
Creation Date Time /Document/FICdtTrf/GrpHdr/CreDtTm	2019-10-07T14:15:00+00:00
Number Of Transactions /Document/FICdtTrf/GrpHdr/NbOfTxs	1
Settlement Method /Document FICdtTrf/GrpHdr/SttlmInf/SttlmMtd	CLRG
Clearing System Code /Document/FICdtTrf/GrpHdr/SttlmInf/ClrSys/Cd	TGT
Credit Transfer Transaction Information	
Payment Identification	
Instruction Identification /Document/FICdtTrf/CdtTrfTxInf/PmtId/InstrId	Inp009b003-InstId

Message item	Utilisation
End To End Identification /Document/FICdtTrf/CdtTrfTxInf/PmtId/EndToEndId	Inp009b003-E2EId
UETR /Document/FICdtTrf/CdtTrfTxInf/PmtId/UETR	e009b003-59c5-41e9-be4c-d45102fc201e
Payment Type Information	
Interbank Settlement Amount Document/FICdtTrf/CdtTrfTxInf/IntrBkSttlmAmt	EUR 450000
Interbank Settlement Date Document/FICdtTrf/CdtTrfTxInf/IntrBkSttlmDt	2019-10-08
Payment Parties	
Instructing Agent BIC /Document/FICdtTrf/CdtTrfTxInf/InstgAgt/FinInstnId/BICFI	MARKDEFFXXX
Instructed Agent BIC /Document/FICdtTrf/CdtTrfTxInf/InstdAgt/FinInstnId/BICFI	SOLADESTXXX
Debtor /Document/FICdtTrf/CdtTrfTxInf/Dbtr/FinInstnId/BICFI	MARKDEFFXXX
Creditor /Document/FICdtTrf/CdtTrfTxInf/Cdtr/FinInstnId/BICFI	SOLADESTXXX

Table 251 - FICreditTransferOrder (pacs.009) – usage case Financial Institution Credit Transfer Order (Scenario 003)

Usage case example: Inbound_pacs.009_CLM_FICreditTransferOrder_bs003.xml

Usage case: Financial Institution Credit Transfer Order (Scenario 004)

In this usage example, the business sender (CB) has requested the movement of EUR 285,000 from its account (with BIC “MARKDEFFXXX”) to a PB MCA (with BIC “SOLADESTXXX”) with a settlement date of 8th October 2019. The message was created and sent on 7 October at 14:15 CET with a settlement date of 9 October. Therefore, it is expected that this payment will be warehoused until the following day.

Message item	Utilisation
Group Header	
Message Identification /Document/FICdtTrf/GrpHdr/MsgId	NONREF

Message item	Utilisation
Creation Date Time /Document/FICdtTrf/GrpHdr/CreDtTm	2019-10-07T14:15:00+00:00
Number Of Transactions /Document/FICdtTrf/GrpHdr/NbOfTxs	1
Settlement Method /Document FICdtTrf/GrpHdr/SttlmInf/SttlmMtd	CLRG
Clearing System Code /Document/FICdtTrf/GrpHdr/SttlmInf/ClrSys/Cd	TGT
Credit Transfer Transaction Information	
Payment Identification	
Instruction Identification /Document/FICdtTrf/CdtTrfTxInf/PmtId/InstrId	Inp009b004-InsId
End To End Identification /Document/FICdtTrf/CdtTrfTxInf/PmtId/EndToEndId	Inp009b004-E2EId
UETR /Document/FICdtTrf/CdtTrfTxInf/PmtId/UETR	e009b004-59c5-41e9-be4c-d45102fc201e
Payment Type Information	
Interbank Settlement Amount Document/FICdtTrf/CdtTrfTxInf/IntrBkSttlmAmt	EUR 285000
Interbank Settlement Date Document/FICdtTrf/CdtTrfTxInf/IntrBkSttlmDt	2019-10-09
Payment Parties	
Instructing Agent BIC /Document/FICdtTrf/CdtTrfTxInf/InstgAgt/FinInstnId/BICFI	MARKDEFFXXX

Message item	Utilisation
Instructed Agent BIC /Document/FICdtTrf/CdtTrfTxInf/InstdAgt/FinInstnId/BICFI	SOLADESTXXX
Debtor /Document/FICdtTrf/CdtTrfTxInf/Dbtr/FinInstnId/BICFI	MARKDEFFXXX
Creditor /Document/FICdtTrf/CdtTrfTxInf/Cdtr/FinInstnId/BICFI	SOLADESTXXX

Table 252 - FICreditTransferOrder (pacs.009) – usage case Financial Institution Credit Transfer Order (Scenario 004)

Usage case example: Inbound_pacs.009_CLM_FICreditTransferOrder_bs004.xml

13.4.3 FinancialInstitutionDirectDebit (pacs.010)

13.4.3.1 Overview and scope of the message

This chapter illustrates the *FinancialInstitutionDirectDebit* message.

This message type is used in CLM to execute a direct debit between two CLM accounts where the business sender is authorised to debit the CLM Account of the business receiver. The *FinancialInstitutionDirectDebit* message concerns only one direct debit movement.

The message can be sent by the following business sender:

- CB

The credited and debited CLM accounts must be denominated in the same currency.

The usage of this message is to be found in chapter [Usage of Messages](#) [▶ 324].

In response to the *FinancialInstitutionDirectDebit* message, a [PaymentStatusReport \(pacs.002\)](#) [▶ 615] message containing the status of the direct debit order may be returned to the business sender.

In addition, if the direct debit order is successfully settled, the *FinancialInstitutionDirectDebit* message is not forwarded to the business receiver of the debited CLM Account. A [BankToCustomerDebitCreditNotification \(camt.054\)](#) [▶ 520] will be sent to the business receiver of the debited CLM Account if they have subscribed to receive it.

In the case of seizure of funds, only the responsible CB is allowed to transfer the respective amount from the CLM MCA to another CLM Account by using a *FinancialInstitutionDirectDebit* message with the dedicated code word “BLKD”.

13.4.3.2 Schema

Outline of the schema

The *FinancialInstitutionDirectDebit* message is composed of the following message building blocks.

GroupHeader

This building block is mandatory and non-repetitive. The identification by the business sender to uniquely and unambiguously identify the message is part of the BAH, therefore the content of message ID is "NONREF".

CreditInstruction

This building block is mandatory and non-repetitive. Set of elements providing information specific to the individual direct debit and relevant for settlement in CLM.

- | credit instruction with credit identification, instructing and instructed agent;
- | direct debit transaction information with payment identification, payment type information, interbank settlement amount, interbank settlement date and settlement time request.

References/links

The CLM specific schema and documentation in XSD/Excel/PDF format as well as the message examples are provided outside of this document under the following link:

http://www.swift.com/mystandards/CLM/pacs.010.001.03_CLM

Business rules applicable to the schema

For business rules applicable to *FinancialInstitutionDirectDebit* refer to the chapter [Index of validation rules and error codes](#) [▶ 643].

13.4.3.3 The message in business context

Specific message requirements

All content must comply with the business rules for the message.

Message item	Utilisation
Group Header	
Message Identification /Document/FIDrctDbt/GrpHdr/MsgId	Value "NONREF" as the message ID is already part of the BAH
Creation Date Time	Date and time at which the message was created.

Message item	Utilisation
/Document/FIDrctDbt/GrpHdr/CreDtTm	
Number Of Transactions /Document/FIDrctDbt/GrpHdr/NbOfTxS	Only "1" is allowed
Credit Instruction	
Credit Identification /Document/FIDrctDbt/CdtInstr/CdtId	Mandatory and ignored by CLM
Instructing Agent BIC /Document/FIDrctDbt/CdtInstr/InstgAg/FinInstnId/BICFI	BIC of the CLM Account to be credited.
Instructed Agent BIC /Document/FIDrctDbt/CdtInstr/InstdAg/FinInstnId/BICFI	BIC of the CLM Account to be debited.
Creditor (Block) /Document/FIDrctDbt/CdtInstr/Cdtr	Mandatory but not relevant for settlement of a direct debit in CLM. BIC is subject to BIC validation.
Direct Debit Transaction Information	
Payment Identification	
Instruction Identification /Document/FIDrctDbt/CdtInstr/DrctDbtTxInf/PmtId/InstrId	It is ignored by CLM
End To End Identification /Document/FIDrctDbt/CdtInstr/DrctDbtTxInf/PmtId/EndToEndId	It is ignored by CLM Invoice number is used in case of billing direct debit
UETR /Document/FIDrctDbt/CdtInstr/DrctDbtTxInf/PmtId/UETR	Universally unique identifier to provide an end-to-end reference of a payment transaction.
Payment Type Information Code /Document/FIDrctDbt/CdtInstr/DrctDbtTxInf/PmtTpInf/LclInstrm/Cd	It is ignored by CLM
Payment Type Information Proprietary /Document/FIDrctDbt/CdtInstr/DrctDbtTxInf/PmtTpInf/LclInstrm/Prtry	Code list used by CLM as follows. <ul style="list-style-type: none"> CONP = Connected payment. A payment by a CB to a CLM Account Holder that triggers both an increase of the credit line on the MCA of the CLM Account Holder and an immediate debit of its account to compensate the change in the credit line. Format: CONP/Amount. Credit line change amount to be provided as delta

Message item	Utilisation
	<p>amount.</p> <ul style="list-style-type: none"> BLKD = Blocked for CBs use only to transfer funds from the seizure of funds reservation. Any bilaterally agreed code word entered by a CB in regards of CBOs. <p>The code words are not validated by CLM.</p>
Interbank Settlement Amount /Document/FIDrctDbt/CdtInstr/DrctDbtTxInf/IntrBkSttlmAmt	Amount relevant for settlement in CLM
Interbank Settlement Date /Document/FIDrctDbt/CdtInstr/DrctDbtTxInf/IntrBkSttlmDt	<p>Date relevant for settlement in CLM.</p> <p>CLM only accepts the current business date, or a future business date as allowed by the CLM warehoused payment period parameter.</p> <p>If the settlement date is not a CLM business day for the indicated currency the payment order will be rejected immediately.</p>
Settlement Time Request	
From Time /Document/FIDrctDbt/CdtInstr/DrctDbtTxInf/SttlmTmReq/FromTm	Used to define an earliest execution time. Must be before the cut-off time for interbank payments.
Reject Time /Document/FIDrctDbt/CdtInstr/DrctDbtTxInf/SttlmTmReq/RejectTm	<p>Used to set a latest execution time. Must be before the cut-off time for interbank payments.</p> <p>If reject time is reached and settlement could not take place, the direct debit order will be rejected.</p>
Payment Parties	
Debtor (Block) /Document/FIDrctDbt/CdtInstr/DrctDbtTxInf/Dbtr	Mandatory but not relevant for settlement of a direct debit in CLM. BIC is subject to BIC validation.
Remittance Information /Document/FIDrctDbt/CdtInstr/DrctDbtTxInf/RmtInf/Ustrd	If provided it is ignored by CLM

Table 253 - FinancialInstitutionDirectDebit (pacs.010)

Usage case: Financial Institution Direct Debit Order (Scenario 005)

In this usage example, the business sender (CB) has requested a direct debit of EUR 25,000 from a PB MCA (with BIC “COBADEFFXXX”) to its CB Account (with BIC “MARKDEFFXXX”) with a settlement date of 27 October 2019. The message was created and sent on 7 October, therefore it is expected that this will fail validation because it is beyond the maximum warehousing period.

Message item	Utilisation
Group Header	
Message Identification /Document/FIDrctDbt/GrpHdr/Msgld	NONREF
Creation Date Time /Document/FIDrctDbt/GrpHdr/CreDtTm	2019-10-07T09:00:00+00:00
Number Of Transactions /Document/FIDrctDbt/GrpHdr/NbOfTxes	1
Credit Instruction	
Credit Identification /Document/FIDrctDbt/CdtInstr/Cdtld	Inp010b005-Cdtld
Instructing Agent BIC /Document/FIDrctDbt/CdtInstr/InstgAgt/FinInstnld/BICFI	MARKDEFFXXX
Instructed Agent BIC /Document/FIDrctDbt/CdtInstr/InstdAgt/FinInstnld/BICFI	COBADEFFXXX
Creditor /Document/FIDrctDbt/CdtInstr/Cdtr/FinInstnld/BICFI	MARKDEFFXXX
Direct Debit Transaction Information	
Payment Identification	
Instruction Identification /Document/FIDrctDbt/CdtInstr/DrctDbtTxInf/Pmtld/Instrld	Inp010b005-Insld
End To End Identification /Document/FIDrctDbt/CdtInstr/DrctDbtTxInf/Pmtld/EndToEndId	Inp010b005-E2Eld
UETR /Document/FIDrctDbt/CdtInstr/DrctDbtTxInf/Pmtld/UETR	e010b005-59c5-41e9-be4c-d45102fc201e

Message item	Utilisation
Interbank Settlement Amount /Document/FIDrctDbt/CdtInstr/DrctDbtTxInf/IntrBkSttlmAmt	EUR 25000
Interbank Settlement Date /Document/FIDrctDbt/CdtInstr/DrctDbtTxInf/IntrBkSttlmDt	2019-10-27
Debtor /Document/FIDrctDbt/CdtInstr/DrctDbtTxInf/Dbtr/FinInstnld/ BICFI	COBADEFFXXX

Table 254 - FinancialInstitutionDirectDebit (pacs.010) – usage case Financial Institution Direct Debit Order (Scenario 005)

Usage case example: Inbound_pacs.010_CLM_FIDirectDebitOrder_bs005.xml

Usage case: Financial Institution Direct Debit Order (Scenario 006)

In this usage example, the business sender (CB) has requested a direct debit movement of EUR 36,000 from a PB MCA (with BIC “COBADEFFXXX”) to its CB Account (with BIC “MARKDEFFXXX”) in respect of a seizure of funds, with a same day settlement date of 7th October.

Message item	Utilisation
Group Header	
Message Identification /Document/FIDrctDbt/GrpHdr/MsgId	NONREF
Creation Date Time /Document/FIDrctDbt/GrpHdr/CreDtTm	2019-10-07T09:00:00+00:00
Number Of Transactions /Document/FIDrctDbt/GrpHdr/NbOfTxS	1
Credit Instruction	
Credit Identification /Document/FIDrctDbt/CdtInstr/CdtId	Inp010b006-CdtId
Instructing Agent BIC /Document/FIDrctDbt/CdtInstr/InstgAgt/FinInstnld/BICFI	MARKDEFFXXX
Instructed Agent BIC /Document/FIDrctDbt/CdtInstr/InstdAgt/FinInstnld/BICFI	COBADEFFXXX
Creditor	MARKDEFFXXX

Message item	Utilisation
/Document/FIDrctDbt/CdtInstr/Cdtr/FinInstnId/BICFI	
Direct Debit Transaction Information	
Payment Identification	
Instruction Identification /Document/FIDrctDbt/CdtInstr/DrctDbtTxInf/PmtId/InstrId	Inp010b006-InsId
End To End Identification /Document/FIDrctDbt/CdtInstr/DrctDbtTxInf/PmtId/EndToEndId	Inp010b006-E2EId
UETR /Document/FIDrctDbt/CdtInstr/DrctDbtTxInf/PmtId/UETR	e010b006-59c5-41e9-be4c-d45102fc201e
Local Instrument Proprietary /Document/FIDrctDbt/CdtInstr/DrctDbtTxInf/PmtTpInf/LclInstrm/Prtry	BLKD
Interbank Settlement Amount /Document/FIDrctDbt/CdtInstr/DrctDbtTxInf/IntrBkSttlmAmt	EUR 36000
Interbank Settlement Date /Document/FIDrctDbt/CdtInstr/DrctDbtTxInf/IntrBkSttlmDt	2019-10-07
Debtor /Document/FIDrctDbt/CdtInstr/DrctDbtTxInf/Dbtr/FinInstnId/BICFI	COBADEFFXXX

Table 255 - FinancialInstitutionDirectDebit (pacs.010) – usage case Financial Institution Direct Debit Order (Scenario 006)

Usage case example: Inbound_pacs.010_CLM_FIDirectDebitOrder_bs006.xml

Usage case: Financial Institution Direct Debit Order (Scenario 007)

In this usage example, the business sender (CB) has requested a direct debit movement of EUR 47,000 from a PB MCA (with BIC “COBADEFFXXX”) to its CB Account (with BIC “MARKDEFFXXX”) with a settlement date of 9 October. The message was created and sent on 7 October at 09:00:00 CET with a settlement date of 9 October. Therefore, it is expected that this payment will be warehoused for two days.

Message item	Utilisation
Group Header	
Message Identification	NONREF

Message item	Utilisation
/Document/FIDrctDbt/GrpHdr/MsgId	
Creation Date Time	2019-10-07T09:00:00+00:00
/Document/FIDrctDbt/GrpHdr/CreDtTm	
Number Of Transactions	1
/Document/FIDrctDbt/GrpHdr/NbOfTx	
Credit Instruction	
Credit Identification	Inp010b007-CdtId
/Document/FIDrctDbt/CdtInstr/CdtId	
Instructing Agent BIC	MARKDEFFXXX
/Document/FIDrctDbt/CdtInstr/InstgAgt/FinInstnId/BICFI	
Instructed Agent BIC	COBADEFFXXX
/Document/FIDrctDbt/CdtInstr/InstdAgt/FinInstnId/BICFI	
Creditor	MARKDEFFXXX
/Document/FIDrctDbt/CdtInstr/Cdtr/FinInstnId/BICFI	
Direct Debit Transaction Information	
Payment Identification	
Instruction Identification	Inp010b007-InslId
/Document/FIDrctDbt/CdtInstr/DrctDbtTxInf/PmtId/InstrId	
End To End Identification	Inp010b007-E2EId
/Document/FIDrctDbt/CdtInstr/DrctDbtTxInf/PmtId/EndToEndId	
UETR	e010b007-59c5-41e9-be4c-d45102fc201e
/Document/FIDrctDbt/CdtInstr/DrctDbtTxInf/PmtId/UETR	

Message item	Utilisation
Interbank Settlement Amount /Document/FIDrctDbt/CdtInstr/DrctDbtTxInf/IntrBkSttlmAmt	EUR 47000
Interbank Settlement Date /Document/FIDrctDbt/CdtInstr/DrctDbtTxInf/IntrBkSttlmDt	2019-10-09
Debtor /Document/FIDrctDbt/CdtInstr/DrctDbtTxInf/Dbtr/FinInstnId/ BICFI	COBADEFFXXX

Table 256 - FinancialInstitutionDirectDebit (pacs.010) – usage case Financial Institution Direct Debit Order (Scenario 007)

Usage case example: Inbound_pacs.010_CLM_FIDirectDebitOrder_bs007.xml

Part IV - Appendixes

14 Index and digital signature

14.1 Index of validation rules and error codes

Files and messages that were received in CLM are submitted through various validations. The validation process verifies that all messages fulfil all predefined criteria and can be further processed. The user is informed about the result via the corresponding business response message.

Reference for all technical and business validation rules is the UDFS, including the spreadsheet published on the ECB Website. The excel which can be downloaded from MyStandard can help the reader understand the elements of the message on which rules are applied, but it is not the reference in terms of validation rules: it may reference rules which are not implemented by T2. MyStandard (online screens or spreadsheet, which are equivalent) is the reference in term of the format definition: message structure and element multiplicity.

The sources used for business validation rule descriptions are ISO 20022 message validations and T2 specific validations. Based on those two validation rule categories, the naming convention for rule-ID and error code are composed as follows:

Source	Rule-ID	Error code	Validation category
ISO	IV00000	X000 D000 H000	ISO 20022 message validations
T2	VR00000	E000	T2 specific validation rules

Table 257 - Validation rule categories

Following a detailed list of error messages and their descriptions are provided. For further details on the GUI refer to the UHB, chapter "*References for Error Messages for GUI Screens*".

The set of business validation rules partially encompasses validations which are not applicable to a certain xpath, e. g. for generic rules for multiple messages or generic rule for certain messages type. For those cases the "xpath of inbound message for validation" does not provide an information and is therefore left empty.

Inbound message type	Response message type	Rule source	Validation rule ID	Validation rule description	Error code	Error description	Xpaths of inbound message elements for validation	Xpath of response message code element	Source rule name
any file	admi.007	T2	VR00010	The message/file must comply with the message/file schema.	E001	Invalid message/file. //Dynamic error including element name//		RctAck/Rpt/ReqHdIlg/Stscd	
any file	admi.007	T2	VR00030	A file must be sent through the store-and-forward network service.	E003	File not sent through the store-and-forward network service		RctAck/Rpt/ReqHdIlg/Stscd	
any instruction message	respective outbound business message for received inbound message	T2	VR00040	An instruction message with the same 'Business Message Identifier' and the same business sender 'From' in the defined timeframe is a duplicate.	E004	Duplicate message. BusinessMessageIdentifier already used by business sender	AppHdr/BizMsgIdrAppHdr/Fr/Flld/Finlnstnld/BICFI	different elements	
any	respective	T2	VR00250	The instruction is	E074	Instruction rejected due		different elements	

Fehler! Verwenden Sie die Registerkarte 'Start', um dem Text zuzuweisen, der hier angezeigt werden soll.

Inbound message type	Response message type	Rule source	Validation rule ID	Validation rule description	Error code	Error description	Xpaths of inbound message elements for validation	Xpath of response message code element	Source rule name
instruction message	outbound business message for received inbound message			rejected by the end-of-day processing according to the relevant cut-off time.		to end-of-day			
any message	admi.007	T2	VR00010	The message/file must comply with the message/file schema.	E001	Invalid message/file. //Dynamic error including element name//	all elements	RctAck/Rpt/ReqHd Ig/StcCd	
any message	admi.007	T2	VR00020	The namespace must be known by the receiving settlement service and the message must be sent through the correct network service (instruction messages via store-and-forward and query messages via real-time network service).	E002	Unknown namespace or wrong network service		RctAck/Rpt/ReqHd Ig/StcCd	

Fehler! Verwenden Sie die Registerkarte 'Start', um Index of validation rules and error codesHeadinq2Reference dem Text zuzuweisen. der hier

Inbound message type	Response message type	Rule source	Validation rule ID	Validation rule description	Error code	Error description	Xpaths of inbound message elements for validation	Xpath of response message code element	Source rule name
any message	respective outbound business message for received inbound message	T2	VR00190	Instructions and queries are only accepted in an appropriate business day phase and till the respective cut-off time (if relevant) according to the use case and the currency of the business sending/entering user.	E018	Message / U2A action outside allowed acceptance time frame		different elements	
head.001	respective outbound business message for received inbound message	T2	VR00060	The element 'Message Definition Identifier' of the BAH must correspond to the namespace of the respective message. For RTGS: In case of pacs.009, the COV and CORE information in the Message Definition	E006	Invalid MessageDefinitionIdentifier	AppHdr/MsgDefldr	different elements	

Fehler! Verwenden Sie die Registerkarte 'Start', um dem Text zuzuweisen, der hier angezeigt werden soll.

Inbound message type	Response message type	Rule source	Validation rule ID	Validation rule description	Error code	Error description	Xpaths of inbound message elements for validation	Xpath of response message code element	Source rule name
				<p>Identifier is mandatory (16th to 18/19th digit), but must be ignored for the comparison.</p> <p>For CLM:</p> <p>This means in case of pacs.009, COV and CORE information in the Message Definition Identifier is not allowed.</p>					
head.001	respective outbound business message for received inbound	T2	VR00080	The technical sender DN must be authorised to send messages for the party of the business sender.	E008	Technical sender not authorised for business sender	AppHdr/Fr/FIId/FinI nstnId/BICFI	different elements	
head.001	respective outbound business	T2	VR00090	The business sending user (system user reference) must be	E009	Business sending user not authorised for business sender	AppHdr/Fr/FIId/FinI nstnId/ClrSysMmbld/Mmbld	different elements	

Fehler! Verwenden Sie die Registerkarte 'Start', um Index of validation rules and error codesHeadinq2Reference dem Text zuzuweisen. der hier

Inbound message type	Response message type	Rule source	Validation rule ID	Validation rule description	Error code	Error description	Xpaths of inbound message elements for validation	Xpath of response message code element	Source rule name
	message for received inbound message			authorised to send messages for the party of the business sender.			AppHdr/Fr/FIId/FinInstnId/BICFI		
head.001	respective outbound business message for received inbound message	T2	VR00091	The certificate DN (business signature) must be linked to the business sending user of the message/file.	E041	Invalid business signature for business sending user	AppHdr/Sgntr AppHdr/Fr/FIId/FinInstnId/ClrSysMmbld/Mmbld	different elements	
head.001	respective outbound business message for received inbound	T2	VR00092	The party of the business sender must not be U2A only.	E114	Business sender must not be U2A only	AppHdr/Fr/FIId/FinInstnId/BICFI	different elements	
head.001	respective outbound	T2	VR00110	The business sending user (system user	E011	Business sending user does not have the	AppHdr/Fr/FIId/FinInstnId/ClrSysMmbld	different elements	

Fehler! Verwenden Sie die Registerkarte 'Start', um dem Text zuzuweisen, der hier angezeigt werden soll.

Inbound message type	Response message type	Rule source	Validation rule ID	Validation rule description	Error code	Error description	Xpaths of inbound message elements for validation	Xpath of response message code element	Source rule name
	business message for received inbound message			reference) must have the privilege to perform this business function.		privilege to perform this business function	d/Mmbld		
head.001	respective outbound business message for received inbound message	ISO	IV00010	If CopyDuplicate is present, then Related MUST be present.	H001	Element Related is missing	AppHdr/Rltd AppHdr/CpyDplct	different elements	RelatedPresentWhenCopyDupl
head.001	respective outbound business message for received inbound message	ISO	IV00320	Only a valid Business identifier code is allowed. Business identifier codes for financial or nonfinancial institutions are registered and published by the ISO 9362 Registration	D008	Invalid financial or non-financial institution BIC in //Dynamic error including xpath//	AppHdr/Rltd/To/FIId/FinInstnId/BICFI AppHdr/Rltd/Fr/FIId/FinInstnId/BICFI AppHdr/To/FIId/FinInstnId/BICFI AppHdr/Fr/FIId/FinI	different elements	AnyBIC

Fehler! Verwenden Sie die Registerkarte 'Start', um Index of validation rules and error codesHeadinq2Reference dem Text zuzuweisen. der hier

Inbound message type	Response message type	Rule source	Validation rule ID	Validation rule description	Error code	Error description	Xpaths of inbound message elements for validation	Xpath of response message code element	Source rule name
				Authority in the ISO directory of BICs, and consists of eleven (11) contiguous characters.			nstnId/BICFI		
head.002	admi.007	T2	VR00050	A file with the same 'Payload Identifier' and the same party of the business sending user (digital signature) in the defined timeframe is a duplicate.	E005	Duplicate file. PayloadIdentifier already used by party of business sending user (Signature)	Xchg/PyldDesc/PyldDtls/PyldIdr	RctAck/Rpt/ReqHdIlg/StsCd	
head.002	admi.007	T2	VR00091	The certificate DN (business signature) must be linked to the business sending user of the message/file.	E041	Invalid business signature for business sending user	Xchg/PyldDesc/ApiSpfcInf/Sgntr Xchg/PyldDesc/ApiSpfcInf/SysUsr	RctAck/Rpt/ReqHdIlg/StsCd	
head.002	admi.007	T2	VR00960	The business sending user (system user reference) must be	E082	Unknown business sending user	Xchg/PyldDesc/ApiSpfcInf/SysUsr	RctAck/Rpt/ReqHdIlg/StsCd	

Fehler! Verwenden Sie die Registerkarte 'Start', um dem Text zuzuweisen, der hier angezeigt werden soll.

Inbound message type	Response message type	Rule source	Validation rule ID	Validation rule description	Error code	Error description	Xpaths of inbound message elements for validation	Xpath of response message code element	Source rule name
				known by the system.					
admi.005	admi.007	T2	VR00100	The business sender 'From' in the BAH must specify: Party BIC of sending party.	E010	Invalid business sender	AppHdr/Fr/FlId/FinInstnId/BICFI	RctAck/Rpt/ReqHdIlg/StcCd	
admi.005	admi.007	T2	VR00120	The business receiver 'To' in the BAH must specify: For RTGS: The RTGS system BIC. For CLM: The CLM system BIC.	E012	Invalid business receiver	AppHdr/To/FlId/FinInstnId/BICFI	RctAck/Rpt/ReqHdIlg/StcCd	
admi.005	admi.007	T2	VR01530	Element 'Report Name' is mandatory.	E136	ReportName missing	RptQryReq/RptQryCrit/SchCrit/RptNm	RctAck/Rpt/ReqHdIlg/StcCd	

Fehler! Verwenden Sie die Registerkarte 'Start', um Index of validation rules and error codesHeadinq2Reference dem Text zuzuweisen. der hier

Inbound message type	Response message type	Rule source	Validation rule ID	Validation rule description	Error code	Error description	Xpaths of inbound message elements for validation	Xpath of response message code element	Source rule name
admi.005	admi.007	T2	VR01550	If code 'GLFQ' in element 'Report Name' is used, the business sender must be a CB.	E138	Code 'GLFQ' in ReportName only allowed for CBs	RptQryReq/RptQry Crit/SchCrit/RptNm AppHdr/Fr/FIId/FinInstnId/BICFI	RctAck/Rpt/ReqHd Ig/StsCd	
admi.005	admi.007	T2	VR01560	If code 'GLFQ' in element 'Report Name' is used, element 'Account Identification' is not allowed.	E139	AccountIdentification not allowed with used ReportName	RptQryReq/RptQry Crit/SchCrit/RptNm RptQryReq/RptQry Crit/SchCrit/AcctId/EQ/Othr/Id	RctAck/Rpt/ReqHd Ig/StsCd	
admi.005	admi.007	T2	VR01570	If element 'Account Identification' is used, all indicated account(s) must be owned by the party indicated in 'Party Identification'.	E140	AccountIdentification not owned by PartyIdentification	RptQryReq/RptQry Crit/SchCrit/AcctId/EQ/Othr/Id RptQryReq/RptQry Crit/SchCrit/PtyId/Id/AnyBIC	RctAck/Rpt/ReqHd Ig/StsCd	
admi.005	admi.007	T2	VR01580	A report must exist for the indicated search criteria and the business	E141	No or not all reports available	RptQryReq/RptQry Crit/SchCrit/AcctId/EQ/Othr/Id	RctAck/Rpt/ReqHd Ig/StsCd	

Fehler! Verwenden Sie die Registerkarte 'Start', um dem Text zuzuweisen, der hier angezeigt werden soll.

Inbound message type	Response message type	Rule source	Validation rule ID	Validation rule description	Error code	Error description	Xpaths of inbound message elements for validation	Xpath of response message code element	Source rule name
				<p>sending party of the query, i.e. previously configured.</p> <p>If element 'Account Identification' is used repetitive, for all indicated accounts a report must exist.</p>			<p>RptQryReq/RptQryCrit/SchCrit/PtyId/Id/AnyBIC</p> <p>AppHdr/Fr/FIId/FinInstnId/BICFI</p>		
admi.005	admi.007	T2	VR01590	<p>The query response consists of more than one message, i.e.</p> <ul style="list-style-type: none"> - for camt.006 and camt.053 query response: in case of more than one page or - for camt.053 query response: in case of more than one statement of account/general ledger 	E142	Query response messages provided in store-and-forward mode		RctAck/Rpt/ReqHdIlg/StsCd	

Fehler! Verwenden Sie die Registerkarte 'Start', um Index of validation rules and error codesHeadinq2Reference dem Text zuzuweisen. der hier

Inbound message type	Response message type	Rule source	Validation rule ID	Validation rule description	Error code	Error description	Xpaths of inbound message elements for validation	Xpath of response message code element	Source rule name
				report. The requested query response messages are provided in store-and-forward mode.					
admi.005	admi.007	T2	VR01600	If code 'GLFQ' in element 'Report Name' is used, the party BIC in element 'Party Identification' must be identical to the BIC of the business sender.	E143	PartyIdentification not BIC of business sender	RptQryReq/RptQry Crit/SchCrit/RptNm RptQryReq/RptQry Crit/SchCrit/PtyId/I d/AnyBIC AppHdr/Fr/FIId/FinI nstnId/BICFI	RctAck/Rpt/ReqHd lg/Stscd	
admi.005	admi.007	ISO	IV00320	Only a valid Business identifier code is allowed. Business identifier codes for financial or nonfinancial institutions are registered and published by the ISO	D008	Invalid financial or non-financial institution BIC in //Dynamic error including xpath//	RptQryReq/RptQry Crit/SchCrit/PtyId/I d/AnyBIC	RctAck/Rpt/ReqHd lg/Stscd	AnyBIC

Fehler! Verwenden Sie die Registerkarte 'Start', um dem Text zuzuweisen, der hier angezeigt werden soll.

Inbound message type	Response message type	Rule source	Validation rule ID	Validation rule description	Error code	Error description	Xpaths of inbound message elements for validation	Xpath of response message code element	Source rule name
				9362 Registration Authority in the ISO directory of BICs, and consists of eleven (11) contiguous characters.					
camt.003	camt.004	T2	VR00100	The business sender 'From' in the BAH must specify: Party BIC of sending party.	E010	Invalid business sender	AppHdr/Fr/FIId/FinInstnId/BICFI	RtrAcct/RptOrErr/OprlErr/Err/Prtry	
camt.003	camt.004	T2	VR00120	The business receiver 'To' in the BAH must specify: For RTGS: The RTGS system BIC. For CLM: The CLM system BIC.	E012	Invalid business receiver	AppHdr/To/FIId/FinInstnId/BICFI	RtrAcct/RptOrErr/OprlErr/Err/Prtry	

Fehler! Verwenden Sie die Registerkarte 'Start', um Index of validation rules and error codesHeadinq2Reference dem Text zuzuweisen. der hier

Inbound message type	Response message type	Rule source	Validation rule ID	Validation rule description	Error code	Error description	Xpaths of inbound message elements for validation	Xpath of response message code element	Source rule name
camt.003	camt.004	T2	VR01250	The specified search criteria must be in the data scope of the business sender.	E110	Search criteria not in data scope of business sender	GetAcct/AcctQryDef/AcctCrit/NewCrit/SchCrit/AcctOwnr/Id/OrgId/AnyBIC GetAcct/AcctQryDef/AcctCrit/NewCrit/SchCrit/AcctId/EQ/Othr/Id GetAcct/AcctQryDef/AcctCrit/NewCrit/SchCrit/AcctSvcr/FinInstnId/BICFI AppHdr/Fr/FIId/FinInstnId/BICFI	RtrAcct/RptOrErr/OprlErr/Err/Prtry	
camt.003	camt.004	T2	VR01260	Elements 'Account Owner', 'Account Identification' or 'Account Servicer' (when available) are optional and mutually exclusive.	E111	Search criteria are mutually exclusive	GetAcct/AcctQryDef/AcctCrit/NewCrit/SchCrit/AcctOwnr GetAcct/AcctQryDef/AcctCrit/NewCrit/SchCrit/AcctId	RtrAcct/RptOrErr/OprlErr/Err/Prtry	

Fehler! Verwenden Sie die Registerkarte 'Start', um dem Text zuzuweisen, der hier angezeigt werden soll.

Inbound message type	Response message type	Rule source	Validation rule ID	Validation rule description	Error code	Error description	Xpaths of inbound message elements for validation	Xpath of response message code element	Source rule name
							GetAcct/AcctQryDef/AcctCrit/NewCrit/SchCrit/AcctSvcr		
camt.003	camt.004	T2	VR01300	<p>If element 'Account Owner' is used: It must be a valid party BIC.</p> <p>If element 'Account Identification' is used: It must be a valid account number.</p> <p>If element 'Account Servicer' is used (only relevant for minimum reserve queries): It must be a valid BIC of a party which is configured as a leading CLM Account Holder</p>	E112	Invalid search criteria	<p>GetAcct/AcctQryDef/AcctCrit/NewCrit/SchCrit/AcctOwnr/Id/OrgId/AnyBIC</p> <p>GetAcct/AcctQryDef/AcctCrit/NewCrit/SchCrit/AcctId/EQ/Othr/Id</p> <p>GetAcct/AcctQryDef/AcctCrit/NewCrit/SchCrit/AcctSvcr/FinInstnId/BICFI</p>	RtrAcct/RptOrErr/OprlErr/Err/Prtry	

Fehler! Verwenden Sie die Registerkarte 'Start', um Index of validation rules and error codesHeadinq2Reference dem Text zuzuweisen. der hier

Inbound message type	Response message type	Rule source	Validation rule ID	Validation rule description	Error code	Error description	Xpaths of inbound message elements for validation	Xpath of response message code element	Source rule name
				subject to minimum reserve holding.					
camt.003	camt.004	T2	VR01430	If element 'Request Type' is used, the currency of the business sender must be 'EUR'.	E127	Invalid currency of business sender for use of RequestType	GetAcct/MsgHdr/R eqTp/Prtry/Id AppHdr/Fr/FIld/Finl nstnId/BICFI	RtrAcct/RptOrErr/ OprlErr/Err/Prtry	
camt.003	camt.004	T2	VR01440	If code 'MRRC' or 'MRRN' in element 'Request Type' is used, the business sender must be a CB.	E128	Invalid business sender for used RequestType	GetAcct/MsgHdr/R eqTp/Prtry/Id AppHdr/Fr/FIld/Finl nstnId/BICFI	RtrAcct/RptOrErr/ OprlErr/Err/Prtry	
camt.003	camt.004	T2	VR01450	If code 'MRFQ' in element 'Request Type' is used and the business sender is not a CB or not a co-manager (which is not the leading CLM Account Holder of its co-managee, but the co-	E129	Business sender not obliged for minimum reserve holdings	GetAcct/MsgHdr/R eqTp/Prtry/Id AppHdr/Fr/FIld/Finl nstnId/BICFI GetAcct/AcctQryD ef/AcctCrit/NewCrit /SchCrit/AcctOwnr/ Id/OrgId/AnyBIC	RtrAcct/RptOrErr/ OprlErr/Err/Prtry	

Fehler! Verwenden Sie die Registerkarte 'Start', um dem Text zuzuweisen, der hier angezeigt werden soll.

Inbound message type	Response message type	Rule source	Validation rule ID	Validation rule description	Error code	Error description	Xpaths of inbound message elements for validation	Xpath of response message code element	Source rule name
				managee (i) holds its minimum reserve directly and (ii) owns only one MCA and no further account(s) in any TARGET settlement service and (iii) is not the leading CLM Account Holder of other parties holding the minimum reserve indirectly) and element 'Account Owner' and 'Account Identification' is not used, the party of the business sender must be obliged for minimum reserve holdings.			GetAcct/AcctQryDef/AcctCrit/NewCrit/SchCrit/AcctId/EQ/Othr/Id		
camt.003	camt.004	T2	VR01460	If element 'Account Servicer' is used, the	E130	Invalid business sender for use of	GetAcct/AcctQryDef/AcctCrit/NewCrit	RtrAcct/RptOrErr/OprlErr/Err/Prtry	

Fehler! Verwenden Sie die Registerkarte 'Start', um Index of validation rules and error codesHeadinq2Reference dem Text zuzuweisen. der hier

Inbound message type	Response message type	Rule source	Validation rule ID	Validation rule description	Error code	Error description	Xpaths of inbound message elements for validation	Xpath of response message code element	Source rule name
				business sender must be a CB or a co-manager (which is not the leading CLM Account Holder of its co-managee, but the co-managee (i) holds its minimum reserve directly and (ii) owns only one MCA and no further account(s) in any TARGET settlement service and (iii) is not the leading CLM Account Holder of other parties holding the minimum reserve indirectly).		AccountServicer	/SchCrit/AcctSvcr/FinInstnId/BICFIAppHdr/Fr/FIId/FinInstnId/BICFI		
camt.003	camt.004	T2	VR01470	If element 'Account Identification' is used, the indicated account must be configured for	E131	Account in AccountIdentification not configured for minimum reserve calculation	GetAcct/AcctQryDef/AcctCrit/NewCrit/SchCrit/AcctId/EQ/Othr/Id	RtrAcct/RptOrErr/OprlErr/Err/Prtry	

Fehler! Verwenden Sie die Registerkarte 'Start', um dem Text zuzuweisen, der hier angezeigt werden soll.

Inbound message type	Response message type	Rule source	Validation rule ID	Validation rule description	Error code	Error description	Xpaths of inbound message elements for validation	Xpath of response message code element	Source rule name
				minimum reserve calculation.					
camt.003	camt.004	T2	VR01480	If element 'Account Owner' is used, the indicated party must be obliged for minimum reserve holdings.	E132	Party in AccountOwner not obliged for minimum reserve holdings	GetAcct/AcctQryDef/AcctCrit/NewCrit/SchCrit/AcctOwnr/Id/OrgId/AnyBIC	RtrAcct/RptOrErr/OprlErr/Err/Prtry	
camt.003	camt.004	T2	VR01490	If element 'Account Servicer' is used, the element 'Request Type' must be used.	E133	AccountServicer not allowed without RequestType	GetAcct/AcctQryDef/AcctCrit/NewCrit/SchCrit/AcctSvcr/FinInstnId/BICFI GetAcct/MsgHdr/ReqTp/Prtry/Id	RtrAcct/RptOrErr/OprlErr/Err/Prtry	
camt.003	camt.004	T2	VR01500	If code 'MRRC' or 'MRRN' in element 'Request Type' is used, element 'Account Identification' is not allowed.	E134	AccountIdentification not allowed with used RequestType	GetAcct/MsgHdr/ReqTp/Prtry/Id GetAcct/AcctQryDef/AcctCrit/NewCrit/SchCrit/AcctId/EQ/Othr/Id	RtrAcct/RptOrErr/OprlErr/Err/Prtry	

Fehler! Verwenden Sie die Registerkarte 'Start', um Index of validation rules and error codesHeadinq2Reference dem Text zuzuweisen. der hier

Inbound message type	Response message type	Rule source	Validation rule ID	Validation rule description	Error code	Error description	Xpaths of inbound message elements for validation	Xpath of response message code element	Source rule name
camt.003	camt.004	ISO	IV00320	Only a valid Business identifier code is allowed. Business identifier codes for financial or nonfinancial institutions are registered and published by the ISO 9362 Registration Authority in the ISO directory of BICs, and consists of eleven (11) contiguous characters.	D008	Invalid financial or non-financial institution BIC in //Dynamic error including xpath//	GetAcct/AcctQryDef/AcctCrit/NewCrit/SchCrit/AcctOwnr/Id/OrgId/AnyBIC GetAcct/AcctQryDef/AcctCrit/NewCrit/SchCrit/AcctSvcr/FinInstnId/BICFI	RtrAcct/RptOrErr/OprlErr/Err/Prtry	AnyBIC
camt.005	camt.006	T2	VR00100	The business sender 'From' in the BAH must specify: Party BIC of sending party.	E010	Invalid business sender	AppHdr/Fr/FIId/FinInstnId/BICFI	RtrTx/RptOrErr/OprlErr/Err/Prtry	
camt.005	camt.006	T2	VR00120	The business receiver 'To' in the BAH must	E012	Invalid business receiver	AppHdr/To/FIId/FinInstnId/BICFI	RtrTx/RptOrErr/OprlErr/Err/Prtry	

Fehler! Verwenden Sie die Registerkarte 'Start', um dem Text zuzuweisen, der hier angezeigt werden soll.

Inbound message type	Response message type	Rule source	Validation rule ID	Validation rule description	Error code	Error description	Xpaths of inbound message elements for validation	Xpath of response message code element	Source rule name
				specify: For RTGS: The RTGS system BIC. For CLM: The CLM system BIC.					
camt.005	camt.006	T2	VR01250	The specified search criteria must be in the data scope of the business sender.	E110	Search criteria not in data scope of business sender	GetTx/TxQryDef/TxCrit/NewCrit/SchCrit/AcctNtrySch/AcctId/EQ/Othr/Id GetTx/TxQryDef/TxCrit/NewCrit/SchCrit/AcctNtrySch/AcctOwNr/Id/OrgId/AnyBIC AppHdr/Fr/FIId/FinInstnId/BICFI	RtrTx/RptOrErr/OpriErr/Err/Prtry	
camt.005	camt.006	T2	VR01260	Elements 'Account Owner', 'Account	E111	Search criteria are mutually exclusive	GetTx/TxQryDef/TxCrit/NewCrit/Sch	RtrTx/RptOrErr/OpriErr/Err/Prtry	

Fehler! Verwenden Sie die Registerkarte 'Start', um Index of validation rules and error codesHeadinq2Reference dem Text zuzuweisen. der hier

Inbound message type	Response message type	Rule source	Validation rule ID	Validation rule description	Error code	Error description	Xpaths of inbound message elements for validation	Xpath of response message code element	Source rule name
				Identification' or 'Account Servicer' (when available) are optional and mutually exclusive.			Crit/AcctNtrySch/AcctId GetTx/TxQryDef/TxCrit/NewCrit/Sch Crit/AcctNtrySch/AcctOwnr		
camt.005	camt.006	T2	VR01330	At least one entry must be found with the specified search criteria.	E118	No data found		RtrTx/RptOrErr/Op rErr/Err/Prtry	
camt.005	camt.006	T2	VR01340	If element 'Interbank Settlement Amount' and/or 'Entry Amount' is used, the indicated currency must be the same as the currency of the business sender.	E119	Invalid Currency for business sender	AppHdr/Fr/FlId/FinInstnId/BICFI GetTx/TxQryDef/TxCrit/NewCrit/Sch Crit/PmtSch/IntrBkStlmAmt/CcyAndAmtRg/Ccy GetTx/TxQryDef/TxCrit/NewCrit/Sch Crit/AcctNtrySch/N	RtrTx/RptOrErr/Op rErr/Err/Prtry	

Fehler! Verwenden Sie die Registerkarte 'Start', um dem Text zuzuweisen, der hier angezeigt werden soll.

Inbound message type	Response message type	Rule source	Validation rule ID	Validation rule description	Error code	Error description	Xpaths of inbound message elements for validation	Xpath of response message code element	Source rule name
							tryAmt/CcyAndAmtRg/Ccy		
camt.005	camt.006	T2	VR01350	If element 'Payment To' is used, 'Member Identification' and 'Country' are mutually exclusive per occurrence and one of them must be used.	E120	Invalid PaymentTo	GetTx/TxQryDef/TxCrit/NewCrit/SchCrit/PmtTo GetTx/TxQryDef/TxCrit/NewCrit/SchCrit/PmtTo/Mmbld GetTx/TxQryDef/TxCrit/NewCrit/SchCrit/PmtTo/Ctry	RtrTx/RptOrErr/OpriErr/Err/Prtry	
camt.005	camt.006	T2	VR01360	If element 'Payment Type' is used, the following values are allowed for each occurrence of the element: For RTGS: LIIE, LIIA, LIAS, LIPU,	E121	Invalid Payment Type	GetTx/TxQryDef/TxCrit/NewCrit/SchCrit/PmtSch/PmtTp/Prtry	RtrTx/RptOrErr/OpriErr/Err/Prtry	

Fehler! Verwenden Sie die Registerkarte 'Start', um Index of validation rules and error codesHeadinq2Reference dem Text zuzuweisen. der hier

Inbound message type	Response message type	Rule source	Validation rule ID	Validation rule description	Error code	Error description	Xpaths of inbound message elements for validation	Xpath of response message code element	Source rule name
				LAUT, LRFB, LRCB, LRQP, LSIE, LSIA, LCCA, REGP, BACP, MANP, ASTI For CLM: LIIE, LIIA, LIPU, LAUT, LRFB, LRCB, LRQP, LSIE, LSIA, LCCA, LCCS, CONP, BLKD, OCBO, CCBT, MCBT, BILI, ODSU, ODRV, ODRF, ODIN, AMLS, AMLR, MLRS, MLRR , MLRV, MLIN, MRIN, MRPN, MREX, MRER, IACP					
camt.005	camt.006	T2	VR01380	If element 'From To Date' is used, 'From Date' must be before 'To Date'.	E123	Invalid FromToDate	GetTx/TxQryDef/TxCrit/NewCrit/SchCrit/PmtSch/Reqd	RtrTx/RptOrErr/OpriErr/Err/Prtry	

Fehler! Verwenden Sie die Registerkarte 'Start', um dem Text zuzuweisen, der hier angezeigt werden soll.

Inbound message type	Response message type	Rule source	Validation rule ID	Validation rule description	Error code	Error description	Xpaths of inbound message elements for validation	Xpath of response message code element	Source rule name
							ExctnDt/DtSch/FrToDt GetTx/TxQryDef/TxCrit/NewCrit/SchCrit/PmtSch/ReqdExctnDt/DtSch/FrToDt/FrDt GetTx/TxQryDef/TxCrit/NewCrit/SchCrit/PmtSch/ReqdExctnDt/DtSch/FrToDt/ToDt		
camt.005	camt.006	T2	VR01390	If element 'From To Amount' is used in message block 'Interbank Settlement Amount' or 'Entry Amount, 'From Amount' must be lower than 'To Amount' in the same message block.	E124	Invalid FromToAmount	GetTx/TxQryDef/TxCrit/NewCrit/SchCrit/PmtSch/IntrBkSttlmAmt/CcyAndAmtRg/Amt/FrToAmount GetTx/TxQryDef/TxCrit/NewCrit/Sch	RtrTx/RptOrErr/OpriErr/Err/Prtry	

Fehler! Verwenden Sie die Registerkarte 'Start', um Index of validation rules and error codes dem Text zuzuweisen. der hier

Inbound message type	Response message type	Rule source	Validation rule ID	Validation rule description	Error code	Error description	Xpaths of inbound message elements for validation	Xpath of response message code element	Source rule name
							Crit/PmtSch/IntrBk SttlmAmt/CcyAndA mtRg/Amt/FrToAm t/FrAmt/BdryAmt GetTx/TxQryDef/T xCrit/NewCrit/Sch Crit/PmtSch/IntrBk SttlmAmt/CcyAndA mtRg/Amt/FrToAm t/ToAmt/BdryAmt GetTx/TxQryDef/T xCrit/NewCrit/Sch Crit/AcctNtrySch/N tryAmt/CcyAndAmt Rg/Amt/FrToAmt GetTx/TxQryDef/T xCrit/NewCrit/Sch Crit/AcctNtrySch/N		

Fehler! Verwenden Sie die Registerkarte 'Start', um dem Text zuzuweisen, der hier angezeigt werden soll.

Inbound message type	Response message type	Rule source	Validation rule ID	Validation rule description	Error code	Error description	Xpaths of inbound message elements for validation	Xpath of response message code element	Source rule name
							tryAmt/CcyAndAmtRg/Amt/FrToAmt/FrAmt/BdryAmt GetTx/TxQryDef/TxCrit/NewCrit/SchCrit/AcctNtrySch/NtryAmt/CcyAndAmtRg/Amt/FrToAmt/ToAmt/BdryAmt		
camt.005	camt.006	T2	VR01400	If element 'Date Time Range' is used in message block 'Payment Search/Processing Validity Time' or 'Account Entry Search/Entry Date/Date Time Search', the related 'From Date Time' must be before or equal to 'To Date Time'.	E125	Invalid DateTimeRange	GetTx/TxQryDef/TxCrit/NewCrit/SchCrit/PmtSch/PrcgVldtyTm/DtTmRg GetTx/TxQryDef/TxCrit/NewCrit/SchCrit/PmtSch/PrcgVldtyTm/DtTmRg/FrDtTm GetTx/TxQryDef/TxCrit/NewCrit/Sch	RtrTx/RptOrErr/OpRlErr/Err/Prtry	

Fehler! Verwenden Sie die Registerkarte 'Start', um Index of validation rules and error codes dem Text zuzuweisen. der hier

Inbound message type	Response message type	Rule source	Validation rule ID	Validation rule description	Error code	Error description	Xpaths of inbound message elements for validation	Xpath of response message code element	Source rule name
							Crit/PmtSch/PrcgVldtyTm/DtTmRg/ToDtTm GetTx/TxQryDef/TxCrit/NewCrit/SchCrit/AcctNtrySch/NtryDt/DtTmSch/DtTmRg GetTx/TxQryDef/TxCrit/NewCrit/SchCrit/AcctNtrySch/NtryDt/DtTmSch/DtTmRg/FrDtTm GetTx/TxQryDef/TxCrit/NewCrit/SchCrit/AcctNtrySch/NtryDt/DtTmSch/DtTmRg/ToDtTm		
camt.005	camt.006	T2	VR01420	If element 'Account	E112	Invalid search criteria	GetTx/TxQryDef/T	RtrTx/RptOrErr/Op	

Fehler! Verwenden Sie die Registerkarte 'Start', um dem Text zuzuweisen, der hier angezeigt werden soll.

Inbound message type	Response message type	Rule source	Validation rule ID	Validation rule description	Error code	Error description	Xpaths of inbound message elements for validation	Xpath of response message code element	Source rule name
				<p>Owner' is used: It must be a valid party BIC.</p> <p>If element 'Account Identification' is used: For each occurrence of the element the account number must be valid.</p>			<p>xCrit/NewCrit/Sch Crit/AcctNtrySch/A cctId/EQ/Othr/Id GetTx/TxQryDef/T xCrit/NewCrit/Sch Crit/AcctNtrySch/A cctOwnr</p>	rErr/Err/Prtry	
camt.005	admi.007	T2	VR01590	<p>The query response consists of more than one message, i.e.</p> <p>- for camt.006 and camt.053 query response: in case of more than one page or</p> <p>- for camt.053 query response: in case of more than one statement</p>	E142	Query response messages provided in store-and-forward mode		RctAck/Rpt/ReqHd lg/StsCd	

Fehler! Verwenden Sie die Registerkarte 'Start', um Index of validation rules and error codes dem Text zuzuweisen. der hier

Inbound message type	Response message type	Rule source	Validation rule ID	Validation rule description	Error code	Error description	Xpaths of inbound message elements for validation	Xpath of response message code element	Source rule name
				of account/general ledger report. The requested query response messages are provided in store-and-forward mode.					
camt.005	camt.006	T2	VR01610	If message block 'Processing Validity Time' is not used, the element 'Instruction' is not allowed. If message block 'Processing Validity Time' is used with one occurrence, the element 'Instruction' must be used as well with one occurrence. If message block	E144	Invalid use of element Instruction	GetTx/TxQryDef/TxCrit/NewCrit/SchCrit/PmtSch/PrcgVldyTm GetTx/TxQryDef/TxCrit/NewCrit/SchCrit/PmtSch/Instr	RtrTx/RptOrErr/OpriErr/Err/Prtry	

Fehler! Verwenden Sie die Registerkarte 'Start', um dem Text zuzuweisen, der hier angezeigt werden soll.

Inbound message type	Response message type	Rule source	Validation rule ID	Validation rule description	Error code	Error description	Xpaths of inbound message elements for validation	Xpath of response message code element	Source rule name
				'Processing Validity Time' is used with two occurrences, the element 'Instruction' must be used as well with two occurrences and the used codes in element 'Instruction' must be different.					
camt.005	camt.006	T2	VR01620	If element 'Interbank Settlement Date' is used, it must be no business date in the past.	E145	Invalid InterbankSettlementDate	GetTx/TxQryDef/TxCrit/NewCrit/SchCrit/PmtSch/IntrBkSttlmDt	RtrTx/RptOrErr/OpRlErr/Err/Prtry	
camt.005	camt.006	T2	VR01630	If message block 'Debtor' is used, the elements 'AnyBIC' and 'Other' are mutually exclusive and one of them must be used.	E146	Invalid Debtor	GetTx/TxQryDef/TxCrit/NewCrit/SchCrit/PmtSch/Pties/Dbtr GetTx/TxQryDef/TxCrit/NewCrit/Sch	RtrTx/RptOrErr/OpRlErr/Err/Prtry	

Fehler! Verwenden Sie die Registerkarte 'Start', um Index of validation rules and error codesHeadinq2Reference dem Text zuzuweisen. der hier

Inbound message type	Response message type	Rule source	Validation rule ID	Validation rule description	Error code	Error description	Xpaths of inbound message elements for validation	Xpath of response message code element	Source rule name
							Crit/PmtSch/Pties/Dbtr/Pty/Id/OrgId/AnyBIC GetTx/TxQryDef/TxCrit/NewCrit/Sch Crit/PmtSch/Pties/Dbtr/Pty/Id/OrgId/Other		
camt.005	camt.006	T2	VR01640	If message block 'Creditor' is used, the elements 'AnyBIC' and 'Other' are mutually exclusive and one of them must be used.	E147	Invalid Creditor	GetTx/TxQryDef/TxCrit/NewCrit/Sch Crit/PmtSch/Pties/Cdtr GetTx/TxQryDef/TxCrit/NewCrit/Sch Crit/PmtSch/Pties/Cdtr/Pty/Id/OrgId/AnyBIC GetTx/TxQryDef/TxCrit/NewCrit/Sch	RtrTx/RptOrErr/Op rErr/Err/Prtry	

Fehler! Verwenden Sie die Registerkarte 'Start', um dem Text zuzuweisen, der hier angezeigt werden soll.

Inbound message type	Response message type	Rule source	Validation rule ID	Validation rule description	Error code	Error description	Xpaths of inbound message elements for validation	Xpath of response message code element	Source rule name
							Crit/PmtSch/Pties/Cdtr/Pty/Id/OrgId/Othr		
camt.005	camt.006	T2	VR01650	Elements 'Request Type/Proprietary/Identification' and 'Query Name' are optional and mutually exclusive.	E148	Elements RequestType/Proprietary/Identification and QueryName are mutually exclusive	GetTx/MsgHdr/ReqTp/Prtry/Id GetTx/TxQryDef/TxCrit/QryNm	RtrTx/RptOrErr/OpriErr/Err/Prtry	
camt.005	camt.006	T2	VR01660	If element 'Query Name' is used, it must be known by the system with the same business sending user of the initialisation query.	E149	QueryName unknown or from different business sending user	GetTx/TxQryDef/TxCrit/QryNm AppHdr/Fr/Flld/FinlnstnId/ClrSysMmbld/Mmbld	RtrTx/RptOrErr/OpriErr/Err/Prtry	
camt.005	camt.006	ISO	IV00210	SearchCriteria or StatementReport or ReturnCriteria must be present.	X210	Invalid message content for SearchCriteria, ReturnCriteria and StatementReport	GetTx/TxQryDef/TxCrit/NewCrit/RtrCrit GetTx/TxQryDef/TxCrit/NewCrit/Sch	RtrTx/RptOrErr/OpriErr/Err/Prtry	SearchAndReturnCriteriaAndStatementReportRule

Fehler! Verwenden Sie die Registerkarte 'Start', um Index of validation rules and error codesHeadinq2Reference dem Text zuzuweisen. der hier

Inbound message type	Response message type	Rule source	Validation rule ID	Validation rule description	Error code	Error description	Xpaths of inbound message elements for validation	Xpath of response message code element	Source rule name
							Crit		
camt.005	camt.006	ISO	IV00280	The code is checked against the list of country names obtained from the United Nations (ISO 3166, Alpha-2 code).	D004	Invalid country code in //Dynamic error including xpath//	GetTx/TxQryDef/TxCrit/NewCrit/SchCrit/PmtTo/Ctry	RtrTx/RptOrErr/Op rErr/Err	Country
camt.005	camt.006	ISO	IV00290	The currency code must be a valid active currency code, not yet withdrawn on the day the message containing the currency is exchanged. Valid active currency codes are registered with the ISO 4217 Maintenance Agency, consist of three (3) contiguous letters, and are not yet withdrawn on the day the message containing the	D005	Invalid active currency code in //Dynamic error including xpath//	GetTx/TxQryDef/TxCrit/NewCrit/SchCrit/PmtSch/IntrBkSttlmAmt/CcyAndAmtRg/Ccy GetTx/TxQryDef/TxCrit/NewCrit/SchCrit/AcctNtrySch/NtryAmt/CcyAndAmtRg/Ccy	RtrTx/RptOrErr/Op rErr/Err	ActiveCurrency

Fehler! Verwenden Sie die Registerkarte 'Start', um dem Text zuzuweisen, der hier angezeigt werden soll.

Inbound message type	Response message type	Rule source	Validation rule ID	Validation rule description	Error code	Error description	Xpaths of inbound message elements for validation	Xpath of response message code element	Source rule name
				Currency is exchanged.					
camt.005	camt.006	ISO	IV00310	<p>The number of fractional digits (or minor unit of currency) must comply with ISO 4217.</p> <p>Note: The decimal separator is a dot.</p>	D007	<p>Invalid decimal digits for the specified currency in //Dynamic error including xpath//</p>	<p>GetTx/TxQryDef/TxCrit/NewCrit/SchCrit/PmtSch/IntrBkSttlmAmt/CcyAndAmtRg/Ccy</p> <p>GetTx/TxQryDef/TxCrit/NewCrit/SchCrit/PmtSch/IntrBkSttlmAmt/CcyAndAmtRg/Amt/FrAmt/BdryAmt</p> <p>GetTx/TxQryDef/TxCrit/NewCrit/SchCrit/PmtSch/IntrBkSttlmAmt/CcyAndAmtRg/Amt/ToAmt/BdryAmt</p> <p>GetTx/TxQryDef/T</p>	RtrTx/RptOrErr/Op rErr/Err	CurrencyAmount

Fehler! Verwenden Sie die Registerkarte 'Start', um Index of validation rules and error codes dem Text zuzuweisen. der hier

Inbound message type	Response message type	Rule source	Validation rule ID	Validation rule description	Error code	Error description	Xpaths of inbound message elements for validation	Xpath of response message code element	Source rule name
							xCrit/NewCrit/Sch Crit/PmtSch/IntrBk SttlmAmt/CcyAndA mtRg/Amt/FrToAm t/FrAmt/BdryAmt GetTx/TxQryDef/T xCrit/NewCrit/Sch Crit/PmtSch/IntrBk SttlmAmt/CcyAndA mtRg/Amt/FrToAm t/ToAmt/BdryAmt GetTx/TxQryDef/T xCrit/NewCrit/Sch Crit/PmtSch/IntrBk SttlmAmt/CcyAndA mtRg/Amt/EQAmt GetTx/TxQryDef/T xCrit/NewCrit/Sch Crit/AcctNtrySch/N tryAmt/CcyAndAmt		

Fehler! Verwenden Sie die Registerkarte 'Start', um dem Text zuzuweisen, der hier angezeigt werden soll.

Inbound message type	Response message type	Rule source	Validation rule ID	Validation rule description	Error code	Error description	Xpaths of inbound message elements for validation	Xpath of response message code element	Source rule name
							Rg/Ccy GetTx/TxQryDef/TxCrit/NewCrit/SchCrit/AcctNtrySch/NtryAmt/CcyAndAmtRg/Amt/FrAmt/BdryAmt GetTx/TxQryDef/TxCrit/NewCrit/SchCrit/AcctNtrySch/NtryAmt/CcyAndAmtRg/Amt/ToAmt/BdryAmt GetTx/TxQryDef/TxCrit/NewCrit/SchCrit/AcctNtrySch/NtryAmt/CcyAndAmtRg/Amt/FrToAmt/FrAmt/BdryAmt		

Fehler! Verwenden Sie die Registerkarte 'Start', um Index of validation rules and error codesHeadinq2Reference dem Text zuzuweisen. der hier

Inbound message type	Response message type	Rule source	Validation rule ID	Validation rule description	Error code	Error description	Xpaths of inbound message elements for validation	Xpath of response message code element	Source rule name
							GetTx/TxQryDef/TxCrit/NewCrit/SchCrit/AcctNtrySch/NtryAmt/CcyAndAmtRg/Amt/FrToAmt/ToAmt/BdryAmt GetTx/TxQryDef/TxCrit/NewCrit/SchCrit/AcctNtrySch/NtryAmt/CcyAndAmtRg/Amt/EQAmt		
camt.005	camt.006	ISO	IV00320	Only a valid Business identifier code is allowed. Business identifier codes for financial or nonfinancial institutions are registered and published by the ISO 9362 Registration	D008	Invalid financial or non-financial institution BIC in //Dynamic error including xpath//	GetTx/TxQryDef/TxCrit/NewCrit/SchCrit/AcctNtrySch/AcctOwnr/Id/OrgId/AnyBIC GetTx/TxQryDef/TxCrit/NewCrit/SchCrit/PmtSch/Pties/I	RtrTx/RptOrErr/OpriErr/Err	AnyBIC

Fehler! Verwenden Sie die Registerkarte 'Start', um dem Text zuzuweisen, der hier angezeigt werden soll.

Inbound message type	Response message type	Rule source	Validation rule ID	Validation rule description	Error code	Error description	Xpaths of inbound message elements for validation	Xpath of response message code element	Source rule name
				Authority in the ISO directory of BICs, and consists of eleven (11) contiguous characters.			nstgAgt/FinInstnId/BICFI GetTx/TxQryDef/TxCrit/NewCrit/SchCrit/PmtSch/Pties/InstdAgt/FinInstnId/BICFI GetTx/TxQryDef/TxCrit/NewCrit/SchCrit/PmtSch/Pties/Dbtr/Pty/Id/OrgId/AnyBIC GetTx/TxQryDef/TxCrit/NewCrit/SchCrit/PmtSch/Pties/DbtrAgt/FinInstnId/BICFI GetTx/TxQryDef/TxCrit/NewCrit/Sch		

Fehler! Verwenden Sie die Registerkarte 'Start', um Index of validation rules and error codes dem Text zuzuweisen. der hier

Inbound message type	Response message type	Rule source	Validation rule ID	Validation rule description	Error code	Error description	Xpaths of inbound message elements for validation	Xpath of response message code element	Source rule name
							Crit/PmtSch/Pties/IntrmyAgt1/FinInstnId/BICFI		
							GetTx/TxQryDef/TxCrit/NewCrit/SchCrit/PmtSch/Pties/CdtrAgt/FinInstnId/BICFI		
							GetTx/TxQryDef/TxCrit/NewCrit/SchCrit/PmtSch/Pties/Cdtr/Pty/Id/OrgId/AnyBIC		
							GetTx/TxQryDef/TxCrit/NewCrit/SchCrit/PmtSch/PmtId/LngBizId/InstAgt/FinInstnId/BICFI		
							GetTx/TxQryDef/T		

Fehler! Verwenden Sie die Registerkarte 'Start', um dem Text zuzuweisen, der hier angezeigt werden soll.

Inbound message type	Response message type	Rule source	Validation rule ID	Validation rule description	Error code	Error description	Xpaths of inbound message elements for validation	Xpath of response message code element	Source rule name
							xCrit/NewCrit/Sch Crit/PmtSch/PmtId/ LngBizId/InstgAgt/ FinInstnId/BICFI GetTx/TxQryDef/T xCrit/NewCrit/Sch Crit/PmtFr/MmblId/ FinInstnId/BICFI GetTx/TxQryDef/T xCrit/NewCrit/Sch Crit/PmtTo/MmblId/ FinInstnId/BICFI		
camt.018	camt.019	T2	VR00100	The business sender 'From' in the BAH must specify: Party BIC of sending party.	E010	Invalid business sender	AppHdr/Fr/FIId/FinInstnId/BICFI	RtrBizDayInf/RptOrErr/OprlErr/Err	
camt.018	camt.019	T2	VR00120	The business receiver 'To' in the BAH must	E012	Invalid business receiver	AppHdr/To/FIId/FinInstnId/BICFI	RtrBizDayInf/RptOrErr/OprlErr/Err	

Fehler! Verwenden Sie die Registerkarte 'Start', um Index of validation rules and error codes dem Text zuzuweisen. der hier

Inbound message type	Response message type	Rule source	Validation rule ID	Validation rule description	Error code	Error description	Xpaths of inbound message elements for validation	Xpath of response message code element	Source rule name
				specify: For RTGS: The RTGS system BIC. For CLM: The CLM system BIC.					
camt.018	camt.019	T2	VR01310	If element 'Request Type/Enquiry' is used, it must contain "RT16"	E115	Invalid value in RequestType/Enquiry	GetBizDayInf/MsgHdr/ReqTp/Enqry	RtrBizDayInf/RptOrErr/OprlErr/Err	
camt.046	camt.047	T2	VR00100	The business sender 'From' in the BAH must specify: Party BIC of sending party.	E010	Invalid business sender	AppHdr/Fr/FlId/FinInstnId/BICFI	RtrRsvatn/RptOrErr/OprlErr/Err	
camt.046	camt.047	T2	VR00120	The business receiver 'To' in the BAH must specify:	E012	Invalid business receiver	AppHdr/To/FlId/FinInstnId/BICFI	RtrRsvatn/RptOrErr/OprlErr/Err	

Fehler! Verwenden Sie die Registerkarte 'Start', um dem Text zuzuweisen, der hier angezeigt werden soll.

Inbound message type	Response message type	Rule source	Validation rule ID	Validation rule description	Error code	Error description	Xpaths of inbound message elements for validation	Xpath of response message code element	Source rule name
				For RTGS: The RTGS system BIC. For CLM: The CLM system BIC.					
camt.046	camt.047	T2	VR01250	The specified search criteria must be in the data scope of the business sender.	E110	Search criteria not in data scope of business sender	GetRsvatn/RsvatnQryDef/RsvatnCrit/NewCrit/SchCrit/AccountOwner/FinInstnId/BICFI GetRsvatn/RsvatnQryDef/RsvatnCrit/NewCrit/SchCrit/AccountId/Othr/IdAppHdr/Fr/FlId/FinInstnId/BICFI	RtrRsvatn/RptOrErr/OprlErr/Err	
camt.046	camt.047	T2	VR01260	Elements 'Account Owner', 'Account Identification' or 'Account Servicer' (when	E111	Search criteria are mutually exclusive	GetRsvatn/RsvatnQryDef/RsvatnCrit/NewCrit/SchCrit/AccountOwner	RtrRsvatn/RptOrErr/OprlErr/Err	

Fehler! Verwenden Sie die Registerkarte 'Start', um Index of validation rules and error codesHeadinq2Reference dem Text zuzuweisen. der hier

Inbound message type	Response message type	Rule source	Validation rule ID	Validation rule description	Error code	Error description	Xpaths of inbound message elements for validation	Xpath of response message code element	Source rule name
				available) are optional and mutually exclusive.			GetRsvatn/RsvatnQryDef/RsvatnCrit/NewCrit/SchCrit/AccountId		
camt.046	camt.047	T2	VR01280	<p>If element 'Account Owner' is used: It must be a valid party BIC.</p> <p>If element 'Account Identification' is used: It must be a valid account number and the account type must be 'RTGS DCA' (for RTGS) or 'MCA' (for CLM).</p>	E112	Invalid search criteria	<p>GetRsvatn/RsvatnQryDef/RsvatnCrit/NewCrit/SchCrit/AccountOwnr/FinInstnId/BICFI</p> <p>GetRsvatn/RsvatnQryDef/RsvatnCrit/NewCrit/SchCrit/AccountId/Othr/IdAppHdr/Fr/FlId/FinInstnId/BICFI</p>	RtrRsvatn/RptOrErr/OprlErr/Err	
camt.046	camt.047	ISO	IV00320	Only a valid Business identifier code is allowed. Business identifier codes for financial or	D008	Invalid financial or non-financial institution BIC in //Dynamic error including xpath//	GetRsvatn/RsvatnQryDef/RsvatnCrit/NewCrit/SchCrit/AccountOwnr/FinInstnId/	RtrRsvatn/RptOrErr/OprlErr/Err	AnyBIC

Fehler! Verwenden Sie die Registerkarte 'Start', um dem Text zuzuweisen, der hier angezeigt werden soll.

Inbound message type	Response message type	Rule source	Validation rule ID	Validation rule description	Error code	Error description	Xpaths of inbound message elements for validation	Xpath of response message code element	Source rule name
				nonfinancial institutions are registered and published by the ISO 9362 Registration Authority in the ISO directory of BICs, and consists of eleven (11) contiguous characters.			BICFI		
camt.048	camt.025	T2	VR00100	The business sender 'From' in the BAH must specify: - for reservation modification/deletion orders sent by the party itself: Party BIC of owner of account given in 'Account Identification' element in the payload; - for reservation modification/deletion	E010	Invalid business sender	AppHdr/Fr/FlId/FinInstnId/BICFI ModifyRsvatn/RsvatnId/Cur/AcctId/Other/Id	Rct/RctDtls/ReqHdIg/StsCd	

Fehler! Verwenden Sie die Registerkarte 'Start', um Index of validation rules and error codesHeadinq2Reference dem Text zuzuweisen. der hier

Inbound message type	Response message type	Rule source	Validation rule ID	Validation rule description	Error code	Error description	Xpaths of inbound message elements for validation	Xpath of response message code element	Source rule name
				orders sent by the CB acting on behalf: Party BIC of responsible CB of owner of account given in 'Account Identification' element in the payload.					
camt.048	camt.025	T2	VR00120	The business receiver 'To' in the BAH must specify: For RTGS: The RTGS system BIC. For CLM: The CLM system BIC.	E012	Invalid business receiver	AppHdr/To/FlId/FinInstnId/BICFI	Rct/RctDtls/ReqHdIg/StsCd	
camt.048	camt.025	T2	VR00700	The business sender of the instruction must be the responsible CB or the operator, if the relevant cash account is	E055	Instruction not possible due to blocked account status	AppHdr/Fr/FlId/FinInstnId/BICFI ModifyRsvatn/RsvatnId/Cur/AcctId/Other/Id	Rct/RctDtls/ReqHdIg/StsCd	

Fehler! Verwenden Sie die Registerkarte 'Start', um dem Text zuzuweisen, der hier angezeigt werden soll.

Inbound message type	Response message type	Rule source	Validation rule ID	Validation rule description	Error code	Error description	Xpaths of inbound message elements for validation	Xpath of response message code element	Source rule name
				- in status "blocked for debits" or "blocked for debits and credits" in case of the following A2A or U2A instructions: camt.007 with element 'Priority' camt.007 with element 'Processing Validity Time' related to pacs.008/pacs.009 camt.011 camt.012 camt.048 camt.049 camt.056 related to pacs.004/pacs.008/pacs.009					

Fehler! Verwenden Sie die Registerkarte 'Start', um Index of validation rules and error codesHeadinq2Reference dem Text zuzuweisen. der hier

Inbound message type	Response message type	Rule source	Validation rule ID	Validation rule description	Error code	Error description	Xpaths of inbound message elements for validation	Xpath of response message code element	Source rule name
				Decrease cash transfer order					
				Increase cash transfer order					
				Modify earliest debit time related to pacs.008/pacs.009					
				Modify latest debit time related to pacs.008/pacs.009					
				Modify priority					
				Modify reservation					
				Modify/Delete limit					
				Revoke cash transfer order related to pacs.004/pacs.008/pacs.009					
				- in status "blocked for					

Fehler! Verwenden Sie die Registerkarte 'Start', um dem Text zuzuweisen, der hier angezeigt werden soll.

Inbound message type	Response message type	Rule source	Validation rule ID	Validation rule description	Error code	Error description	Xpaths of inbound message elements for validation	Xpath of response message code element	Source rule name
				credits" or "blocked for debits and credits" in case of the following A2A or U2A instructions: camt.007 with element 'Processing Validity Time' related to pacs.010 camt.056 related to pacs.010 Modify earliest debit time related to pacs.010 Modify latest debit time related to pacs.010 Revoke cash transfer order related to pacs.010					
camt.048	camt.025	T2	VR00860	For RTGS: Modification is only possible for account type 'RTGS DCA'.	E069	Instruction not allowed for this account type	ModfyRsvatn/Rsva tnId/Cur/AcctId/Oth r/Id	Rct/RctDtIs/ReqHd lg/StcCd	

Fehler! Verwenden Sie die Registerkarte 'Start', um Index of validation rules and error codesHeadinq2Reference dem Text zuzuweisen. der hier

Inbound message type	Response message type	Rule source	Validation rule ID	Validation rule description	Error code	Error description	Xpaths of inbound message elements for validation	Xpath of response message code element	Source rule name
				For CLM: Modification is only possible for account type 'MCA'.					
camt.048	camt.025	T2	VR00870	Modification with message block 'Default' is not allowed in RTGS or CLM. It can be addressed to CRDM only.	E070	Message block Default not allowed	ModfyRsvatn/RsvatnId/Dflt	Rct/RctDtIs/ReqHdIlg/StsCd	
camt.048	camt.025	T2	VR00880	The specified currency for the requested amount must be the same as the one of the specified account(s).	E071	Invalid currency for account	ModfyRsvatn/NewRsvatnValSet/Amt/AmtWthCcy/Ccy	Rct/RctDtIs/ReqHdIlg/StsCd	
camt.048	camt.025	T2	VR00890	Element 'Start Date Time' is not allowed.	E072	Element StartDateTime not allowed	ModfyRsvatn/NewRsvatnValSet/StartDtTm	Rct/RctDtIs/ReqHdIlg/StsCd	

Fehler! Verwenden Sie die Registerkarte 'Start', um dem Text zuzuweisen, der hier angezeigt werden soll.

Inbound message type	Response message type	Rule source	Validation rule ID	Validation rule description	Error code	Error description	Xpaths of inbound message elements for validation	Xpath of response message code element	Source rule name
camt.048	camt.025	T2	VR00900	The pending modification is rejected due to a new modification / deletion request.	E073	Pending modification rejected due to new modification / deletion request		Rct/RctDtls/ReqHdIlg/StsCd	
camt.048	camt.025	T2	VR00970	Account number must be known in the addressed settlement service.	E007	Account number / Account BIC in indicated currency unknown in addressed settlement service	ModfyRsvatn/RsvatnId/Cur/AcctId/Oth r/Id	Rct/RctDtls/ReqHdIlg/StsCd	
camt.048	camt.025	T2	VR00980	Code 'BLKD' is only allowed, if business sender is the responsible CB.	E077	Code 'BLKD' only allowed by responsible CB	AppHdr/Fr/FIId/FinInstnId/BICFI ModfyRsvatn/RsvatnId/Cur/Tp/Cd	Rct/RctDtls/ReqHdIlg/StsCd	
camt.048	camt.025	T2	VR01060	Code 'UPAR' and 'HPAR' are not allowed in CLM.	E090	Code 'UPAR' and 'HPAR' not allowed	ModfyRsvatn/RsvatnId/Cur/Tp/Cd	Rct/RctDtls/ReqHdIlg/StsCd	
camt.048	camt.025	ISO	IV00290	The currency code must be a valid active currency code, not yet withdrawn	D005	Invalid active currency code in //Dynamic error including xpath//	ModfyRsvatn/NewRsvatnValSet/Amt/AmtWthCcy/Ccy	Rct/RctDtls/ReqHdIlg/StsCd	ActiveCurrency

Fehler! Verwenden Sie die Registerkarte 'Start', um Index of validation rules and error codesHeadinq2Reference dem Text zuzuweisen. der hier

Inbound message type	Response message type	Rule source	Validation rule ID	Validation rule description	Error code	Error description	Xpaths of inbound message elements for validation	Xpath of response message code element	Source rule name
				on the day the message containing the currency is exchanged. Valid active currency codes are registered with the ISO 4217 Maintenance Agency, consist of three (3) contiguous letters, and are not yet withdrawn on the day the message containing the Currency is exchanged.					
camt.048	camt.025	ISO	IV00310	The number of fractional digits (or minor unit of currency) must comply with ISO 4217. Note: The decimal separator is a dot.	D007	Invalid decimal digits for the specified currency in //Dynamic error including xpath//	ModfyRsvatn/New RsvatnValSet/Amt/ AmtWthCcy ModfyRsvatn/New RsvatnValSet/Amt/ AmtWthCcy/Ccy	Rct/RctDtls/ReqHd lg/Stscd	CurrencyAmount
camt.049	camt.025	T2	VR00100	The business sender	E010	Invalid business sender	AppHdr/Fr/Flld/Finl	Rct/RctDtls/ReqHd	

Fehler! Verwenden Sie die Registerkarte 'Start', um dem Text zuzuweisen, der hier angezeigt werden soll.

Inbound message type	Response message type	Rule source	Validation rule ID	Validation rule description	Error code	Error description	Xpaths of inbound message elements for validation	Xpath of response message code element	Source rule name
				'From' in the BAH must specify: - for reservation modification/deletion orders sent by the party itself: Party BIC of owner of account given in 'Account Identification' element in the payload; - for reservation modification/deletion orders sent by the CB acting on behalf: Party BIC of responsible CB of owner of account given in 'Account Identification' element in the payload.			nstnId/BICFI DelRsvatn/CurRsvatn/AcctId/Othr/Id	lg/StsCd	
camt.049	camt.025	T2	VR00120	The business receiver 'To' in the BAH must specify:	E012	Invalid business receiver	AppHdr/To/FlId/FinInstnId/BICFI	Rct/RctDtIs/ReqHd lg/StsCd	

Fehler! Verwenden Sie die Registerkarte 'Start', um Index of validation rules and error codesHeadinq2Reference dem Text zuzuweisen. der hier

Inbound message type	Response message type	Rule source	Validation rule ID	Validation rule description	Error code	Error description	Xpaths of inbound message elements for validation	Xpath of response message code element	Source rule name
				<p>For RTGS: The RTGS system BIC.</p> <p>For CLM: The CLM system BIC.</p>					
camt.049	camt.025	T2	VR00700	<p>The business sender of the instruction must be the responsible CB or the operator, if the relevant cash account is</p> <p>- in status "blocked for debits" or "blocked for debits and credits" in case of the following A2A or U2A instructions:</p> <p>camt.007 with element 'Priority'</p> <p>camt.007 with element</p>	E055	Instruction not possible due to blocked account status	AppHdr/Fr/FIld/FinInstnId/BICFI DelRsvatn/CurRsvatn/AcctId/Othr/Id	Rct/RctDtls/ReqHdIlg/StsCd	

Fehler! Verwenden Sie die Registerkarte 'Start', um dem Text zuzuweisen, der hier angezeigt werden soll.

Inbound message type	Response message type	Rule source	Validation rule ID	Validation rule description	Error code	Error description	Xpaths of inbound message elements for validation	Xpath of response message code element	Source rule name
				'Processing Validity Time' related to pacs.008/pacs.009 camt.011 camt.012 camt.048 camt.049 camt.056 related to pacs.004/pacs.008/pacs.009 Decrease cash transfer order Increase cash transfer order Modify earliest debit time related to pacs.008/pacs.009 Modify latest debit time					

Fehler! Verwenden Sie die Registerkarte 'Start', um Index of validation rules and error codesHeadinq2Reference dem Text zuzuweisen. der hier

Inbound message type	Response message type	Rule source	Validation rule ID	Validation rule description	Error code	Error description	Xpaths of inbound message elements for validation	Xpath of response message code element	Source rule name
				related to pacs.008/pacs.009 Modify priority Modify reservation Modify/Delete limit Revoke cash transfer order related to pacs.004/pacs.008/pacs.009 - in status "blocked for credits" or "blocked for debits and credits" in case of the following A2A or U2A instructions: camt.007 with element 'Processing Validity Time' related to pacs.010 camt.056 related to pacs.010					

Fehler! Verwenden Sie die Registerkarte 'Start', um dem Text zuzuweisen, der hier angezeigt werden soll.

Inbound message type	Response message type	Rule source	Validation rule ID	Validation rule description	Error code	Error description	Xpaths of inbound message elements for validation	Xpath of response message code element	Source rule name
				Modify earliest debit time related to pacs.010 Modify latest debit time related to pacs.010 Revoke cash transfer order related to pacs.010					
camt.049	camt.025	T2	VR00911	A reservation deletion is only possible, if the reservation for this account exists.	E075	No limit/reservation defined	DelRsvatn/CurRsvatn/Tp/Cd DelRsvatn/CurRsvatn/AcctId/Othr/Id	Rct/RctDtls/ReqHdIlg/StsCd	
camt.049	camt.025	T2	VR00970	Account number must be known in the addressed settlement service.	E007	Account number / Account BIC in indicated currency unknown in addressed settlement service	DelRsvatn/CurRsvatn/AcctId/Othr/Id	Rct/RctDtls/ReqHdIlg/StsCd	
camt.049	camt.025	T2	VR00980	Code 'BLKD' is only allowed, if business sender is the responsible	E077	Code 'BLKD' only allowed by responsible CB	"AppHdr/Fr/FIId/FInInstId/BICFI	VR00980	

Fehler! Verwenden Sie die Registerkarte 'Start', um Index of validation rules and error codesHeadinq2Reference dem Text zuzuweisen. der hier

Inbound message type	Response message type	Rule source	Validation rule ID	Validation rule description	Error code	Error description	Xpaths of inbound message elements for validation	Xpath of response message code element	Source rule name
				CB.					
camt.050	camt.025	T2	VR00100	<p>The business sender 'From' in the BAH must specify:</p> <p>For RTGS:</p> <ul style="list-style-type: none"> - for liquidity transfer orders sent by the party itself: Party BIC of owner of account given in 'Debtor Account' element in the payload; - for liquidity transfer orders sent by the CB acting on behalf: Party BIC of responsible CB of owner of account given in 'Debtor Account' element in the payload. 	E010	Invalid business sender	AppHdr/Fr/FlId/FinInstnId/BICFI LqdyCdtTrf/LqdyCdtTrf/DbtrAcct/Id/Othr/Id	Rct/RctDtls/ReqHdIlg/StsCd	

Fehler! Verwenden Sie die Registerkarte 'Start', um dem Text zuzuweisen, der hier angezeigt werden soll.

Inbound message type	Response message type	Rule source	Validation rule ID	Validation rule description	Error code	Error description	Xpaths of inbound message elements for validation	Xpath of response message code element	Source rule name
				<p>For CLM:</p> <ul style="list-style-type: none"> - for liquidity transfer orders (incl. overnight deposit setting up orders) sent by the party itself: Party BIC of owner of account given in 'Debtor Account' element in the payload; - for liquidity transfer orders (incl. overnight deposit setting up orders) sent by the co-manager: Party BIC of co-manager of co-managed account given in 'Debtor Account' element in the payload; - for liquidity transfer orders (incl. overnight deposit setting up orders) 					

Fehler! Verwenden Sie die Registerkarte 'Start', um Index of validation rules and error codesHeadinq2Reference dem Text zuzuweisen. der hier

Inbound message type	Response message type	Rule source	Validation rule ID	Validation rule description	Error code	Error description	Xpaths of inbound message elements for validation	Xpath of response message code element	Source rule name
				<p>sent by the CB acting on behalf: Party BIC of responsible CB of owner of account given in 'Debtor Account' element in the payload;</p> <p>- for overnight deposit reverse orders sent by the party itself: Party BIC of CLM Account Holder linked to overnight deposit account;</p> <p>- for overnight deposit reverse orders sent by the co-manager: Party BIC of co-manager of CLM Account Holder linked to overnight deposit account;</p> <p>- for overnight deposit</p>					

Fehler! Verwenden Sie die Registerkarte 'Start', um dem Text zuzuweisen, der hier angezeigt werden soll.

Inbound message type	Response message type	Rule source	Validation rule ID	Validation rule description	Error code	Error description	Xpaths of inbound message elements for validation	Xpath of response message code element	Source rule name
				reverse orders sent by the responsible CB: Party BIC of owner of account given in 'Debtor Account' element in the payload; - for marginal lending setting up orders sent by the CB (till ECMS go-live): Party BIC of owner of account given in 'Debtor Account' element in the payload.					
camt.050	camt.025	T2	VR00120	The business receiver 'To' in the BAH must specify: For RTGS: The RTGS system BIC.	E012	Invalid business receiver	AppHdr/To/FlId/FinInstnId/BICFI	Rct/RctDtIs/ReqHdIlg/StcCd	

Fehler! Verwenden Sie die Registerkarte 'Start', um Index of validation rules and error codesHeadinq2Reference dem Text zuzuweisen. der hier

Inbound message type	Response message type	Rule source	Validation rule ID	Validation rule description	Error code	Error description	Xpaths of inbound message elements for validation	Xpath of response message code element	Source rule name
				For CLM: The CLM system BIC.					
camt.050	camt.025	T2	VR00252	At least one of the impacted parties or accounts is blocked. The earmarked cash transfer order has been disagreed by the respective CB/OT.	E023	Central bank disagreed to earmarked cash transfer order		Rct/RctDtIs/ReqHdIlg/StsCd	
camt.050	camt.025	T2	VR00410	'Debtor Account' and 'Creditor Account' must be known cash accounts in the addressed settlement service for the indicated currency.	E007	Account number / Account BIC in indicated currency unknown in addressed settlement service	LqdyCdtTrf/LqdyCdtTrf/DbtrAcct/Id/Othr/Id LqdyCdtTrf/LqdyCdtTrf/CdtrAcct/Id/Othr/Id LqdyCdtTrf/LqdyCdtTrf/TrfdAmt/AmountWthCcy/Ccy	Rct/RctDtIs/ReqHdIlg/StsCd	
camt.050	camt.025	T2	VR00440	For CLM:	E032	Inter-service liquidity	LqdyCdtTrf/Lqdy	Rct/RctDtIs/ReqHd	

Fehler! Verwenden Sie die Registerkarte 'Start', um dem Text zuzuweisen, der hier angezeigt werden soll.

Inbound message type	Response message type	Rule source	Validation rule ID	Validation rule description	Error code	Error description	Xpaths of inbound message elements for validation	Xpath of response message code element	Source rule name
				<p>If the debtor account is one of the following account types, the creditor account must be a CLM cash account:</p> <ul style="list-style-type: none"> - CLM dedicated transit account for RTGS; - CLM dedicated transit account for T2S; - CLM dedicated transit account for TIPS; - Technical account for CONT settlement; - CB ECB account; - ECB mirror account. <p>For RTGS:</p> <p>If the debtor account is an RTGS dedicated</p>		transfer not allowed for debtor account type	<p>CdtTrf/DbtrAcct/Id/Othr/Id</p> <p>LqdyCdtTrf/LqdyCdtTrf/CdtrAcct/Id/Othr/Id</p>	Ig/StsCd	

Fehler! Verwenden Sie die Registerkarte 'Start', um Index of validation rules and error codesHeadinq2Reference dem Text zuzuweisen. der hier

Inbound message type	Response message type	Rule source	Validation rule ID	Validation rule description	Error code	Error description	Xpaths of inbound message elements for validation	Xpath of response message code element	Source rule name
				transit account, the creditor account must be an RTGS cash account.					
camt.050	camt.025	T2	VR00450	If debtor and creditor accounts of an intra-service liquidity transfer order have the following account type For RTGS: - RTGS DCA, For CLM: - MCA, both accounts have to belong to the same liquidity transfer group.	E035	Debtor and creditor accounts not in same liquidity transfer group	LqdyCdtTrf/LqdyCdtTrf/DbtrAcct/Id/Othr/Id LqdyCdtTrf/LqdyCdtTrf/CdtrAcct/Id/Othr/Id	Rct/RctDtls/ReqHdIg/StsCd	
camt.050	camt.025	T2	VR00460	If the creditor account is an overnight deposit account, the debtor	E036	Invalid creditor/debit account type or party not linked for overnight	LqdyCdtTrf/LqdyCdtTrf/DbtrAcct/Id/Othr/Id	Rct/RctDtls/ReqHdIg/StsCd	

Fehler! Verwenden Sie die Registerkarte 'Start', um dem Text zuzuweisen, der hier angezeigt werden soll.

Inbound message type	Response message type	Rule source	Validation rule ID	Validation rule description	Error code	Error description	Xpaths of inbound message elements for validation	Xpath of response message code element	Source rule name
				account must be an MCA linked to the overnight deposit account to be credited.		deposit reversal/setting up.			
camt.050	camt.025	T2	VR00470	If the debtor account is an overnight deposit account, the creditor account must be an MCA linked to the overnight deposit account to be debited.	E036	Invalid creditor/debit account type or party not linked for overnight deposit reversal/setting up.	LqdyCdtTrf/Lqdy CdtTrf/DbtrAcct/Id/Othr/Id	Rct/RctDtIs/ReqHd Ig/StsCd	
camt.050	camt.025	T2	VR00480	If the debtor account is a marginal lending account, the creditor account must be an MCA linked to the marginal lending account to be debited.	E037	Invalid marginal lending account for party of the creditor account or creditor account no MCA	LqdyCdtTrf/Lqdy CdtTrf/DbtrAcct/Id/Othr/Id	Rct/RctDtIs/ReqHd Ig/StsCd	
camt.050	camt.025	T2	VR00485	The party linked to the	E097	Party not allowed to use	LqdyCdtTrf/Lqdy	Rct/RctDtIs/ReqHd	

Fehler! Verwenden Sie die Registerkarte 'Start', um Index of validation rules and error codes dem Text zuzuweisen. der hier

Inbound message type	Response message type	Rule source	Validation rule ID	Validation rule description	Error code	Error description	Xpaths of inbound message elements for validation	Xpath of response message code element	Source rule name
				<p>account must be allowed to use standing facilities:</p> <ul style="list-style-type: none"> - in case the creditor account is an overnight deposit account; - in case the debtor account is an marginal lending account. 		standing facilities	<p>CdtTrf/DbtrAcct/Id/Othr/Id</p> <p>LqdyCdtTrf/LqdyCdtTrf/CdtrAcct/Id/Othr/Id</p>	Ig/StsCd	
camt.050	camt.025	T2	VR00490	<p>The creditor account must be a valid account with the following account type</p> <p>For CLM:</p> <ul style="list-style-type: none"> - any CLM cash account except marginal lending account; - RTGS DCA, T2S DCA, 	E014	Invalid account type for InstructedAgent (pacs) or CreditorAccount (camt)	<p>LqdyCdtTrf/LqdyCdtTrf/CdtrAcct/Id/Othr/Id</p>	Rct/RctDtls/ReqHd/Ig/StsCd	

Fehler! Verwenden Sie die Registerkarte 'Start', um dem Text zuzuweisen, der hier angezeigt werden soll.

Inbound message type	Response message type	Rule source	Validation rule ID	Validation rule description	Error code	Error description	Xpaths of inbound message elements for validation	Xpath of response message code element	Source rule name
				<p>TIPS account or TIPS AS technical account;</p> <ul style="list-style-type: none"> - RTGS sub account; - RTGS CB account or T2S CB account. <p>For RTGS:</p> <ul style="list-style-type: none"> - RTGS DCA; - RTGS sub-account; - RTGS dedicated transit account; - RTGS CB account, CLM CB account or T2S CB account; - CLM overnight deposit account; - MCA, T2S DCA, TIPS account or TIPS AS 					

Fehler! Verwenden Sie die Registerkarte 'Start', um Index of validation rules and error codesHeadinq2Reference dem Text zuzuweisen. der hier

Inbound message type	Response message type	Rule source	Validation rule ID	Validation rule description	Error code	Error description	Xpaths of inbound message elements for validation	Xpath of response message code element	Source rule name
				technical account.					
camt.050	camt.025	T2	VR00500	<p>The following cash account types can only be credited if the business sender is the responsible CB of the account</p> <p>For RTGS: - RTGS dedicated transit account</p> <p>For CLM: - CLM dedicated transit account for RTGS; - CLM dedicated transit account for T2S; - CLM dedicated transit account for TIPS; - Technical account for</p>	E038	No authorisation to credit CreditorAccount	AppHdr/Fr/FlId/FinInstnId/BICFI LqdyCdtTrf/LqdyCdtTrf/TrfdAmt/AmountWthCcy/Ccy	Rct/RctDtls/ReqHeader/StsCd	

Fehler! Verwenden Sie die Registerkarte 'Start', um dem Text zuzuweisen, der hier angezeigt werden soll.

Inbound message type	Response message type	Rule source	Validation rule ID	Validation rule description	Error code	Error description	Xpaths of inbound message elements for validation	Xpath of response message code element	Source rule name
				CONT settlement; - CB ECB account; - ECB mirror account.					
camt.050	camt.025	T2	VR00520	The debtor account must be a valid account with the following account type For CLM: - any CLM cash account For RTGS: - RTGS DCA; - RTGS sub-account; - RTGS dedicated transit account; - RTGS CB account.	E013	Invalid account type for InstructingAgent (pacs) or DebtorAccount (camt)	LqdyCdtTrf/Lqdy CdtTrf/DbtrAcct/ld/Othr/ld	Rct/RctDtls/ReqHd lg/Stscd	

Fehler! Verwenden Sie die Registerkarte 'Start', um Index of validation rules and error codesHeadinq2Reference dem Text zuzuweisen. der hier

Inbound message type	Response message type	Rule source	Validation rule ID	Validation rule description	Error code	Error description	Xpaths of inbound message elements for validation	Xpath of response message code element	Source rule name
camt.050	camt.025	T2	VR00530	A liquidity transfer order with the following identical field content for the current business day is a duplicate: - debtor account; - message type; - creditor account; - end to end identification; - settlement date; - settlement amount.	E015	Duplicate message payload	LqdyCdtTrf/LqdyCdtTrf/DbtrAcct/Id/Othr/Id LqdyCdtTrf/LqdyCdtTrf/CdtrAcct/Id/Othr/Id LqdyCdtTrf/LqdyCdtTrf/LqdyTrfId/EndToEndId LqdyCdtTrf/LqdyCdtTrf/StlmDt LqdyCdtTrf/LqdyCdtTrf/TrfdAmt/AmountWithCcy	Rct/RctDtls/ReqHdIlg/StsCd	
camt.050	camt.025	T2	VR00540	The settlement date must be the current business day.	E040	Settlement date must specify the current business day	LqdyCdtTrf/LqdyCdtTrf/StlmDt	Rct/RctDtls/ReqHdIlg/StsCd	
camt.050	camt.025	T2	VR00560	The account to be debited must have	E042	Insufficient liquidity		Rct/RctDtls/ReqHdIlg/StsCd	

Fehler! Verwenden Sie die Registerkarte 'Start', um dem Text zuzuweisen, der hier angezeigt werden soll.

Inbound message type	Response message type	Rule source	Validation rule ID	Validation rule description	Error code	Error description	Xpaths of inbound message elements for validation	Xpath of response message code element	Source rule name
				sufficient liquidity.					
camt.050	camt.025	T2	VR00570	If the creditor account is an overnight deposit account held by a CB outside the Eurosystem, the sum of all overnight deposits with this CB must not exceed the maximum envisaged amount for this CB.	E043	Sum of overnight deposits exceeds the maximum amount for central bank	LqdyCdtTrf/LqdyCdtTrf/CdtrAcct/ld/Othr/ld	Rct/RctDtls/ReqHdIg/StsCd	
camt.050	camt.025	T2	VR01070	The inter-service liquidity transfer has been rejected by the receiving settlement service.	E091	Inter-service liquidity transfer rejected by receiving settlement service		Rct/RctDtls/ReqHdIg/StsCd	
camt.050	camt.025	T2	VR01100	For RTGS: The account to be debited must have no queued cash transfer orders with a higher	E100	Settlement not possible due to FIFO		Rct/RctDtls/ReqHdIg/StsCd	

Fehler! Verwenden Sie die Registerkarte 'Start', um Index of validation rules and error codesHeadinq2Reference dem Text zuzuweisen. der hier

Inbound message type	Response message type	Rule source	Validation rule ID	Validation rule description	Error code	Error description	Xpaths of inbound message elements for validation	Xpath of response message code element	Source rule name
				<p>queue position.</p> <p>For CLM: The account to be debited must have no queued cash transfer orders or pending tasks related to credit line modification, seizure of funds reservation or CBO reservation.</p>					
camt.050	camt.025	T2	VR01230	A liquidity transfer debiting a marginal lending account is not allowed after ECMS go-live.	E098	Liquidity transfer on marginal lending account not allowed after ECMS go-live	LqdyCdtTrf/LqdyCdtTrf/DbtrAcct/Id/Othr/Id	Rct/RctDtls/ReqHdIg/StsCd	
camt.050	camt.025	ISO	IV00290	The currency code must be a valid active currency code, not yet withdrawn on the day the message	D005	Invalid active currency code in //Dynamic error including xpath//	LqdyCdtTrf/LqdyCdtTrf/TrfdAmt/AmountWithCcy/Ccy	Rct/RctDtls/ReqHdIg/StsCd	ActiveCurrency

Fehler! Verwenden Sie die Registerkarte 'Start', um dem Text zuzuweisen, der hier angezeigt werden soll.

Inbound message type	Response message type	Rule source	Validation rule ID	Validation rule description	Error code	Error description	Xpaths of inbound message elements for validation	Xpath of response message code element	Source rule name
				containing the currency is exchanged. Valid active currency codes are registered with the ISO 4217 Maintenance Agency, consist of three (3) contiguous letters, and are not yet withdrawn on the day the message containing the Currency is exchanged.					
camt.050	camt.025	ISO	IV00310	The number of fractional digits (or minor unit of currency) must comply with ISO 4217. Note: The decimal separator is a dot.	D007	Invalid decimal digits for the specified currency in //Dynamic error including xpath//	LqdyCdtTrf/LqdyCdtTrf/TrfAmt/Am tWthCcy LqdyCdtTrf/LqdyCdtTrf/TrfAmt/Am tWthCcy/Ccy	Rct/RctDtls/ReqHd lg/Stscd	CurrencyAmount
camt.050	camt.025	ISO	IV00320	Only a valid Business identifier code is allowed.	D008	Invalid financial or non-financial institution BIC in	LqdyCdtTrf/LqdyCdtTrf/Dbtr/FinInst	Rct/RctDtls/ReqHd lg/Stscd	AnyBIC

Fehler! Verwenden Sie die Registerkarte 'Start', um Index of validation rules and error codesHeadinq2Reference dem Text zuzuweisen. der hier

Inbound message type	Response message type	Rule source	Validation rule ID	Validation rule description	Error code	Error description	Xpaths of inbound message elements for validation	Xpath of response message code element	Source rule name
				Business identifier codes for financial or nonfinancial institutions are registered and published by the ISO 9362 Registration Authority in the ISO directory of BICs, and consists of eleven (11) contiguous characters.		//Dynamic error including xpath//	nId/BICFI LqdyCdtTrf/LqdyCdtTrf/Cdtr/FinInstnId/BICFI		
camt.056	camt.029	T2	VR00100	The business sender 'From' in the BAH must specify: For RTGS: - for payment revocation and recall orders sent by the party itself: An Addressee BIC of account given in	E010	Invalid business sender	AppHdr/Fr/FIId/FinInstnId/BICFI FIToFIPmtCxlReq/Assgnmt/Assgnr/Agmt/FinInstnId/BICFI FIToFIPmtCxlReq/Undrlyg/TxInf/OrgnIIntrBkSttlmAmt/Ccy	RsltnOfInvstgtn/CxlDtls/TxInfAndSts/CxlStsRsnInf/Rsn/Prtry	

Fehler! Verwenden Sie die Registerkarte 'Start', um dem Text zuzuweisen, der hier angezeigt werden soll.

Inbound message type	Response message type	Rule source	Validation rule ID	Validation rule description	Error code	Error description	Xpaths of inbound message elements for validation	Xpath of response message code element	Source rule name
				<p>'Assigner' element in the payload; - for payment revocation and recall orders sent by the CB acting on behalf: Party BIC of responsible CB of owner of account given in 'Assigner' element in the payload.</p> <p>For CLM: Party BIC of owner of account given in 'Assigner' element in the payload.</p>					
camt.056	camt.029	T2	VR00120	<p>The business receiver 'To' in the BAH must specify:</p> <p>For RTGS:</p>	E012	Invalid business receiver	AppHdr/To/FlId/FinInstnId/BICFI + For RTGS: FIToFIPmtCxlReq/	RsltnOfInvstgtn/CxlDtIs/TxInfAndSts/CxlStsRsnInf/Rsn/Prtry	

Fehler! Verwenden Sie die Registerkarte 'Start', um Index of validation rules and error codesHeadinq2Reference dem Text zuzuweisen. der hier

Inbound message type	Response message type	Rule source	Validation rule ID	Validation rule description	Error code	Error description	Xpaths of inbound message elements for validation	Xpath of response message code element	Source rule name
				An Addressee BIC of the account given in 'Assignee' element in the payload. For CLM: The CLM system BIC.			Assgnmt/Assgne/Agt/FinInstnId/BICFI FIToFIPmtCxlReq/Undrlyg/TxInf/Orgn llntrBkSttlmAmt/Ccy		
camt.056	camt.029	T2	VR00700	The business sender of the instruction must be the responsible CB or the operator, if the relevant cash account is - in status "blocked for debits" or "blocked for debits and credits" in case of the following A2A or U2A instructions: camt.007 with element 'Priority'	E055	Instruction not possible due to blocked account status	AppHdr/Fr/Flld/FinInstnId/BICFI FIToFIPmtCxlReq/Assgnmt/Assgnr/Agt/FinInstnId/BICFI FIToFIPmtCxlReq/Undrlyg/TxInf/Orgn llntrBkSttlmAmt/Ccy	RsltnOfInvstgtn/CxlDtls/TxInfAndSts/CxlStsRsnInf/Rsn/Priority	

Fehler! Verwenden Sie die Registerkarte 'Start', um dem Text zuzuweisen, der hier angezeigt werden soll.

Inbound message type	Response message type	Rule source	Validation rule ID	Validation rule description	Error code	Error description	Xpaths of inbound message elements for validation	Xpath of response message code element	Source rule name
				camt.007 with element 'Processing Validity Time' related to pacs.008/pacs.009 camt.011 camt.012 camt.048 camt.049 camt.056 related to pacs.004/pacs.008/pacs.009 Decrease cash transfer order Increase cash transfer order Modify earliest debit time related to pacs.008/pacs.009					

Fehler! Verwenden Sie die Registerkarte 'Start', um Index of validation rules and error codesHeadinq2Reference dem Text zuzuweisen. der hier

Inbound message type	Response message type	Rule source	Validation rule ID	Validation rule description	Error code	Error description	Xpaths of inbound message elements for validation	Xpath of response message code element	Source rule name
				Modify latest debit time related to pacs.008/pacs.009 Modify priority Modify reservation Modify/Delete limit Revoke cash transfer order related to pacs.004/pacs.008/pacs.009 - in status "blocked for credits" or "blocked for debits and credits" in case of the following A2A or U2A instructions: camt.007 with element 'Processing Validity Time'					

Fehler! Verwenden Sie die Registerkarte 'Start', um dem Text zuzuweisen, der hier angezeigt werden soll.

Inbound message type	Response message type	Rule source	Validation rule ID	Validation rule description	Error code	Error description	Xpaths of inbound message elements for validation	Xpath of response message code element	Source rule name
				related to pacs.010 camt.056 related to pacs.010 Modify earliest debit time related to pacs.010 Modify latest debit time related to pacs.010 Revoke cash transfer order related to pacs.010					
camt.056	camt.029	T2	VR00775	For RTGS: A payment revocation and recall order is only allowed for the following message types: - pacs.004 - pacs.008 - pacs.009 - pacs.010	E081	Invalid OriginalMessageNameId entification	FIToFIPmtCxlReq/ Undrlyg/TxInf/Orgn IGrpInf/OrgnIMsgNmId	RsltnOfInvstgtn/Cxl Dtls/TxInfAndSts/C xlStsRsnInf/Rsn/Pr try	

Fehler! Verwenden Sie die Registerkarte 'Start', um Index of validation rules and error codesHeadinq2Reference dem Text zuzuweisen. der hier

Inbound message type	Response message type	Rule source	Validation rule ID	Validation rule description	Error code	Error description	Xpaths of inbound message elements for validation	Xpath of response message code element	Source rule name
				For CLM: A payment revocation order is only allowed for the following message types: - pacs.009 - pacs.010					
camt.056	camt.029	T2	VR00780	For RTGS: Revocation of pacs.004 and pacs.010 is only possible if the payment order exists. For CLM: Revocation is only possible if the payment order exists.	E053	No payment found	FIToFIPmtCxlReq/Undrlyg/TxInf	RsltnOfInvstgtn/CxlDtls/TxInfAndSts/CxlStsRsnInf/Rsn/Prtry	
camt.056	camt.029	T2	VR00800	Payments with final status cannot be revoked.	E064	Revocation of payments with final status not possible	FIToFIPmtCxlReq/Undrlyg/TxInf	RsltnOfInvstgtn/CxlDtls/TxInfAndSts/CxlStsRsnInf/Rsn/Pr	

Fehler! Verwenden Sie die Registerkarte 'Start', um dem Text zuzuweisen, der hier angezeigt werden soll.

Inbound message type	Response message type	Rule source	Validation rule ID	Validation rule description	Error code	Error description	Xpaths of inbound message elements for validation	Xpath of response message code element	Source rule name
								try	
camt.056	camt.029	T2	VR00830	<p>A payment revocation and recall order with the following identical field content in the defined timeframe is a duplicate:</p> <ul style="list-style-type: none"> - assigner; - message type; - original message type; - assignee; - original UETR; - original end to end identification; - original settlement date; - original settlement amount. 	E015	Duplicate message payload	<p>FIToFIPmtCxlReq/Assgnmt/Assgnr/Ag/FinInstnId/BICFIAppHdr/MsgDefldr</p> <p>FIToFIPmtCxlReq/Undrlyg/TxInf/OrgnIGrpInf/OrgnIMsgNmId</p> <p>FIToFIPmtCxlReq/Assgnmt/Assgne/Ag/FinInstnId/BICFI</p> <p>FIToFIPmtCxlReq/Undrlyg/TxInf/OrgnIUETR</p> <p>FIToFIPmtCxlReq/Undrlyg/TxInf/OrgnIEndToEndId</p>	RsltnOfInvstgtn/CxlDtIs/TxInfAndSts/CxlStsRsnInf/Rsn/Prtry	

Fehler! Verwenden Sie die Registerkarte 'Start', um Index of validation rules and error codesHeadinq2Reference dem Text zuzuweisen. der hier

Inbound message type	Response message type	Rule source	Validation rule ID	Validation rule description	Error code	Error description	Xpaths of inbound message elements for validation	Xpath of response message code element	Source rule name
							FIToFIPmtCxlReq/ Undrlyg/TxInf/Orgn lIntrBkSttlmDt FIToFIPmtCxlReq/ Undrlyg/TxInf/Orgn lIntrBkSttlmAmt		
camt.056	camt.029	T2	VR01290	Revocation by a CB is only allowed for payment orders sent by the CB (i.e. not sent by ECMS).	E113	Revocation not allowed	FIToFIPmtCxlReq/ Undrlyg/TxInf	RsltnOfInvstgtn/Cxl DtIs/TxInfAndSts/C xlStsRsnInf/Rsn/Pr try	
camt.056	camt.029	ISO	IV00290	The currency code must be a valid active currency code, not yet withdrawn on the day the message containing the currency is exchanged. Valid active currency codes are registered with the ISO 4217 Maintenance	D005	Invalid active currency code in //Dynamic error including xpath//	FIToFIPmtCxlReq/ Undrlyg/TxInf/Orgn lIntrBkSttlmAmt/Cc y	RsltnOfInvstgtn/Cxl DtIs/TxInfAndSts/C xlStsRsnInf/Rsn/Pr try	ActiveCurrency

Fehler! Verwenden Sie die Registerkarte 'Start', um dem Text zuzuweisen, der hier angezeigt werden soll.

Inbound message type	Response message type	Rule source	Validation rule ID	Validation rule description	Error code	Error description	Xpaths of inbound message elements for validation	Xpath of response message code element	Source rule name
				Agency, consist of three (3) contiguous letters, and are not yet withdrawn on the day the message containing the Currency is exchanged.					
camt.056	camt.029	ISO	IV00310	The number of fractional digits (or minor unit of currency) must comply with ISO 4217. Note: The decimal separator is a dot.	D007	Invalid decimal digits for the specified currency in //Dynamic error including xpath//	FIToFIPmtCxlReq/Undrlyg/TxInf/Orgn lIntrBkStlImAmt FIToFIPmtCxlReq/Undrlyg/TxInf/Orgn lIntrBkStlImAmt/Ccy	RsltnOfInvstgtn/CxlDtls/TxInfAndSts/CxlStsRsnInf/Rsn/Prtry	CurrencyAmount
Camt.056	Camt.029	ISO	IV00320	Only a valid Business identifier code is allowed. Business identifier codes for financial or nonfinancial institutions are registered and	D008	[Invalid financial or non-financial institution BIC in //Dynamic error including xpath//	FIToFIPmtCxlReq/Assgnmt/Assgne/Ag t/FinInstnId/BICFI FIToFIPmtCxlReq/Assgnmt/Assgnr/Ag t/FinInstnId/BICFI	FIToFIPmtStsRpt/TxInfAndSts/StsRsnInf/Rsn/Prtry	AnyBIC

Fehler! Verwenden Sie die Registerkarte 'Start', um Index of validation rules and error codesHeadinq2Reference dem Text zuzuweisen. der hier

Inbound message type	Response message type	Rule source	Validation rule ID	Validation rule description	Error code	Error description	Xpaths of inbound message elements for validation	Xpath of response message code element	Source rule name
				published by the ISO 9362 Registration Authority in the ISO directory of BICs, and consists of eleven (11) contiguous characters.					
camt.998	admi.007	T2	VR00021	If element 'Proprietary Data/Type' contains value 'GetPenalty', the camt.998 message must be sent through the real-time network service. camt.998 messages with all other allowed values in this element must be sent through the store-and-forward network service.	E002	Unknown namespace or wrong network service	PrtryMsg/PrtryData /Tp	RctAck/Rpt/ReqHd lg/Stscd	
camt.998	admi.007	T2	VR01030	Element 'Proprietary Data/Type' must contain	E084	Invalid ProprietaryData/Type	PrtryMsg/PrtryData /Tp	RctAck/Rpt/ReqHd lg/Stscd	

Fehler! Verwenden Sie die Registerkarte 'Start', um dem Text zuzuweisen, der hier angezeigt werden soll.

Inbound message type	Response message type	Rule source	Validation rule ID	Validation rule description	Error code	Error description	Xpaths of inbound message elements for validation	Xpath of response message code element	Source rule name
				one of the following values: 'ModifyCreditLine'; 'AuthorizePenalty'; 'GetPenalty'; 'InsertBalanceMinimumReserve'; 'InsertValueOfMinimumReserve'.					
camt.998	admi.007	T2	VR01040	Element 'Proprietary Data/Type' must be present	E001	Invalid message/file. //Dynamic error including element name//	PrtryMsg/PrtryData /Tp	RctAck/Rpt/ReqHd lg/Stscd	
camt.998_AuthorizePenaltyMinimumReserve	camt.025	T2	IV00320	Only a valid Business identifier code is allowed. Business identifier codes for financial or nonfinancial institutions are registered and	D008	Invalid financial or non-financial institution BIC in //Dynamic error including xpath//	PrtryMsg/PrtryData /Data/T2PrtryData/PnltyMgmtId/CtrPtyId/BIC	Rct/RctDtls/ReqHd lg/Stscd	

Fehler! Verwenden Sie die Registerkarte 'Start', um Index of validation rules and error codesHeadinq2Reference dem Text zuzuweisen. der hier

Inbound message type	Response message type	Rule source	Validation rule ID	Validation rule description	Error code	Error description	Xpaths of inbound message elements for validation	Xpath of response message code element	Source rule name
				published by the ISO 9362 Registration Authority in the ISO directory of BICs, and consists of eleven (11) contiguous characters.					
camt.998_AuthorizePenaltyMinimumReserve	camt.025	T2	VR00100	The business sender 'From' in the BAH must specify: Party BIC of responsible CB of party given in 'Counterparty Identification' element in the payload.	E010	Invalid business sender	AppHdr/Fr/FlId/FinInstnId/BICFI PrtryMsg/PrtryData/Data/T2PrtryData/PnntyMgmtId/CtrptyId/BIC	Rct/RctDtls/ReqHdIlg/StsCd	
camt.998_AuthorizePenaltyMinimumReserve	camt.025	T2	VR00120	The business receiver 'To' in the BAH must specify: The CLM system BIC.	E012	Invalid business receiver	AppHdr/To/FlId/FinInstnId/BICFI	Rct/RctDtls/ReqHdIlg/StsCd	
camt.998_AuthorizePenaltyMinimumReserve	camt.025	T2	VR01170	The element 'Penalty	E116	Invalid PenaltyType	PrtryMsg/PrtryData	Rct/RctDtls/ReqHdIlg/StsCd	

Fehler! Verwenden Sie die Registerkarte 'Start', um dem Text zuzuweisen, der hier angezeigt werden soll.

Inbound message type	Response message type	Rule source	Validation rule ID	Validation rule description	Error code	Error description	Xpaths of inbound message elements for validation	Xpath of response message code element	Source rule name
authorizePenaltyMinimumReserve				Type" must be used, if element 'PenaltyStatus' has value 'PAY' otherwise it is not allowed.			/Data/T2PrtryData/NewPnltyValSet/PnltyTp PrtryMsg/PrtryData/Data/T2PrtryData/NewPnltyValSet/PnltySts	Ig/StsCd	
camt.998_AuthorizePenaltyMinimumReserve	camt.025	T2	VR01200	An 'AuthorizePenalty' can only be sent in case a penalty exists.	E107	No penalty for indicated institution available	PrtryMsg/PrtryData/Data/T2PrtryData/PnltyMgmtId/CtrPtyId/BIC	Rct/RctDtIs/ReqHdIg/StsCd	
camt.998_AuthorizePenaltyMinimumReserve	camt.025	T2	VR01210	Indicated maintenance period must be valid (when used).	E105	Invalid maintenance period	PrtryMsg/PrtryData/Data/T2PrtryData/NewPnltyValSet/MntncPrd/FrDt PrtryMsg/PrtryData/Data/T2PrtryData/NewPnltyValSet/MntncPrd/ToDt	Rct/RctDtIs/ReqHdIg/StsCd	

Fehler! Verwenden Sie die Registerkarte 'Start', um Index of validation rules and error codesHeadinq2Reference dem Text zuzuweisen. der hier

Inbound message type	Response message type	Rule source	Validation rule ID	Validation rule description	Error code	Error description	Xpaths of inbound message elements for validation	Xpath of response message code element	Source rule name
camt.998_AuthorizePenaltyMinimumReserve	camt.025	T2	VR01320	A penalty with a final status cannot be authorised/cancelled.	E117	Authorisation/cancellation not possible due to final penalty status		Rct/RctDtls/ReqHdIlg/Stscd	
camt.998_GetPenaltyMinimumReserve	camt.998_ReturnPenaltyMinimumReserve	T2	IV00320	Only a valid Business identifier code is allowed. Business identifier codes for financial or nonfinancial institutions are registered and published by the ISO 9362 Registration Authority in the ISO directory of BICs, and consists of eleven (11) contiguous characters.	D008	Invalid financial or non-financial institution BIC in //Dynamic error including xpath//	PrtryMsg/PrtryData/Data/T2PrtryData/PnltyMgmtId/CtrPtYld/BIC	PrtryMsg/PrtryData/Data/T2PrtryData/OprlErr/Err/Prtry	
camt.998_GetPenaltyMinimumReserve	camt.998_ReturnPenaltyMinimumReserve	T2	VR00100	The business sender 'From' in the BAH must specify:	E010	Invalid business sender	AppHdr/Fr/Flld/FinlnstnId/BICFI	PrtryMsg/PrtryData/Data/T2PrtryData/OprlErr/Err/Prtry	

Fehler! Verwenden Sie die Registerkarte 'Start', um dem Text zuzuweisen, der hier angezeigt werden soll.

Inbound message type	Response message type	Rule source	Validation rule ID	Validation rule description	Error code	Error description	Xpaths of inbound message elements for validation	Xpath of response message code element	Source rule name
	e			Party BIC of sending party.					
camt.998_Ge tPenaltyMini mumReserve	camt.998_Ret urnPenaltyMi nimumReserv e	T2	VR00101	The business sender must be a CB.	E028	Business sender must be a CB	AppHdr/Fr/FinId/FinInstnId/BICFI	PrtryMsg/PrtryData/Data/T2PrtryData/OprlErr/Err/Prtry	
camt.998_Ge tPenaltyMini mumReserve	camt.998_Ret urnPenaltyMi nimumReserv e	T2	VR00120	The business receiver 'To' in the BAH must specify: The CLM system BIC.	E012	Invalid business receiver	AppHdr/To/FinId/FinInstnId/BICFI	PrtryMsg/PrtryData/Data/T2PrtryData/OprlErr/Err/Prtry	
camt.998_Ge tPenaltyMini mumReserve	camt.998_Ret urnPenaltyMi nimumReserv e	T2	VR01210	Indicated maintenance period must be valid (when used).	E105	Invalid maintenance period	PrtryMsg/PrtryData/Data/T2PrtryData/MntncPrd/PrtryMsg/PrtryData/Data/T2PrtryData/MntncPrd/ToDt	PrtryMsg/PrtryData/Data/T2PrtryData/OprlErr/Err/Prtry	
camt.998_Ge tPenaltyMini mumReserve	camt.998_Ret urnPenaltyMi nimumReserv	T2	VR01250	The specified search criteria must be in the data scope of the	E110	Search criteria not in data scope of business sender	PrtryMsg/PrtryData/Data/T2PrtryData/PnltyMgmtId/CtrPt	PrtryMsg/PrtryData/Data/T2PrtryData/OprlErr/Err/Prtry	

Fehler! Verwenden Sie die Registerkarte 'Start', um Index of validation rules and error codesHeadinq2Reference dem Text zuzuweisen. der hier

Inbound message type	Response message type	Rule source	Validation rule ID	Validation rule description	Error code	Error description	Xpaths of inbound message elements for validation	Xpath of response message code element	Source rule name
	e			business sender.			yld/BIC		
camt.998_Ge tPenaltyMini mumReserve	camt.998_Ret urnPenaltyMi nimumReserve	T2	VR01330	At least one entry must be found with the specified search criteria.	E118	No data found	PrtryMsg/PrtryData /Data/T2PrtryData/ PnltyMgmtId/CtrPt yld/BIC PrtryMsg/PrtryData /Data/T2PrtryData/ MntncPrd PrtryMsg/PrtryData /Data/T2PrtryData/ PnltySts	PrtryMsg/PrtryData /Data/T2PrtryData/ OprlErr/Err/Prtry	
camt.998_Ge tPenaltyMini mumReserve	camt.998_Ret urnPenaltyMi nimumReserve	T2	VR01510	If element 'Counterparty Identification' is used, it must be a valid BIC of a party which is configured as a leading CLM Account Holder obliged for minimum reserve holdings.	E112	Invalid search criteria	PrtryMsg/PrtryData /Data/T2PrtryData/ PnltyMgmtId/CtrPt yld/BIC	PrtryMsg/PrtryData /Data/T2PrtryData/ OprlErr/Err/Prtry	

Fehler! Verwenden Sie die Registerkarte 'Start', um dem Text zuzuweisen, der hier angezeigt werden soll.

Inbound message type	Response message type	Rule source	Validation rule ID	Validation rule description	Error code	Error description	Xpaths of inbound message elements for validation	Xpath of response message code element	Source rule name
camt.998_Ge tPenaltyMini mumReserve	camt.998_Ret urnPenaltyMi nimumReserve	T2	VR01520	At least one of the following elements must be used as search criteria: - 'Counterparty Identification' - 'Maintenance Period' - 'Penalty Status'	E135	Search criteria missing	PrtryMsg/PrtryData/Data/T2PrtryData/PnltyMgmtId/CtrPtyId/BIC PrtryMsg/PrtryData/Data/T2PrtryData/MntncPrd PrtryMsg/PrtryData/Data/T2PrtryData/PnltySts	PrtryMsg/PrtryData/Data/T2PrtryData/OprlErr/Err/Prtry	
camt.998_Ins ertBalanceMi nimumReserve	camt.025	T2	IV00280	The code is checked against the list of country names obtained from the United Nations (ISO 3166, Alpha-2 code).	D004	Invalid country code in //Dynamic error including xpath//	PrtryMsg/PrtryData/Data/PrtryData/MgmtId/Ctry	Rct/RctDtls/ReqHdIlg/StsCd	
camt.998_Ins ertBalanceMi nimumReserve	camt.025	T2	IV00320	Only a valid Business identifier code is allowed. Business identifier codes for financial or	D008	Invalid financial or non-financial institution BIC in //Dynamic error including xpath//	PrtryMsg/PrtryData/Data/PrtryData/Ne wBalValSet/CtrPtyId/BIC	Rct/RctDtls/ReqHdIlg/StsCd	

Fehler! Verwenden Sie die Registerkarte 'Start', um Index of validation rules and error codesHeadinq2Reference dem Text zuzuweisen. der hier

Inbound message type	Response message type	Rule source	Validation rule ID	Validation rule description	Error code	Error description	Xpaths of inbound message elements for validation	Xpath of response message code element	Source rule name
				nonfinancial institutions are registered and published by the ISO 9362 Registration Authority in the ISO directory of BICs, and consists of eleven (11) contiguous characters.					
camt.998_InsertBalanceMinimumReserve	camt.025	T2	VR00100	The business sender 'From' in the BAH must specify: Party BIC of responsible CB of party given in 'Counterparty Identification' element in the payload.	E010	Invalid business sender	AppHdr/Fr/FIId/FinInstnId/BICFI PrtryMsg/PrtryData/Data/PrtryData/NewBalValSet/CtrPtyId/BIC	Rct/RctDtls/ReqHdIlg/StsCd	
camt.998_InsertBalanceMinimumReserve	camt.025	T2	VR00120	The business receiver 'To' in the BAH must specify: The CLM system BIC.	E012	Invalid business receiver	AppHdr/To/FIId/FinInstnId/BICFI	Rct/RctDtls/ReqHdIlg/StsCd	

Fehler! Verwenden Sie die Registerkarte 'Start', um dem Text zuzuweisen, der hier angezeigt werden soll.

Inbound message type	Response message type	Rule source	Validation rule ID	Validation rule description	Error code	Error description	Xpaths of inbound message elements for validation	Xpath of response message code element	Source rule name
camt.998_InsertBalanceMinimumReserve	camt.025	T2	VR01150	The currency code must be 'EUR'.	E102	Currency code not EUR	PrtryMsg/PrtryData/Data/PrtryData/NewBalValSet/Bal/Amt/Ccy	Rct/RctDtls/ReqHdIlg/StsCd	
camt.998_InsertBalanceMinimumReserve	camt.025	T2	VR01160	The 'InsertBalanceMinimumReserve' message can only be sent for institutions subject to pool or direct minimum reserve obligation.	E103	Institution not subject to direct or pool minimum reserve obligation	PrtryMsg/PrtryData/Data/PrtryData/NewBalValSet/CtrPtyId/BIC	Rct/RctDtls/ReqHdIlg/StsCd	
camt.998_InsertBalanceMinimumReserve	camt.025	T2	VR01190	The indicated value date must be a valid business day of the current maintenance period.	E106	Invalid ValueDate	PrtryMsg/PrtryData/Data/PrtryData/NewBalValSet/Bal/ValueDt/Dt	Rct/RctDtls/ReqHdIlg/StsCd	
camt.998_InsertBalanceMinimumReserve	camt.025	T2	VR01220	Element 'Country' must match the country code of the sending CB.	E109	Invalid Country	PrtryMsg/PrtryData/Data/PrtryData/MgmtId/Ctry	Rct/RctDtls/ReqHdIlg/StsCd	

Fehler! Verwenden Sie die Registerkarte 'Start', um Index of validation rules and error codesHeadinq2Reference dem Text zuzuweisen. der hier

Inbound message type	Response message type	Rule source	Validation rule ID	Validation rule description	Error code	Error description	Xpaths of inbound message elements for validation	Xpath of response message code element	Source rule name
camt.998_InsertValueOfReserveMinimumReserve	camt.025	T2	IV00320	Only a valid Business identifier code is allowed. Business identifier codes for financial or nonfinancial institutions are registered and published by the ISO 9362 Registration Authority in the ISO directory of BICs, and consists of eleven (11) contiguous characters.	D008	Invalid financial or non-financial institution BIC in //Dynamic error including xpath//	PrtryMsg/PrtryData/Data/T2PrtryData/MinRsrvMgmtId/CtrPtyId/BIC	Rct/RctDtls/ReqHdIlg/StsCd	
camt.998_InsertValueOfReserveMinimumReserve	camt.025	T2	VR00100	The business sender 'From' in the BAH must specify: Party BIC of responsible CB of party given in 'Counterparty Identification' element in the payload.	E010	Invalid business sender	AppHdr/Fr/FlId/FinInstnId/BICFI PrtryMsg/PrtryData/Data/T2PrtryData/MinRsrvMgmtId/CtrPtyId/BIC	Rct/RctDtls/ReqHdIlg/StsCd	

Fehler! Verwenden Sie die Registerkarte 'Start', um dem Text zuzuweisen, der hier angezeigt werden soll.

Inbound message type	Response message type	Rule source	Validation rule ID	Validation rule description	Error code	Error description	Xpaths of inbound message elements for validation	Xpath of response message code element	Source rule name
camt.998_InsertValueOfReserveMinimumReserve	camt.025	T2	VR00120	The business receiver 'To' in the BAH must specify: The CLM system BIC.	E012	Invalid business receiver	AppHdr/To/FinInstnId/BICFI	Rct/RctDtls/ReqHdIlg/StsCd	
camt.998_InsertValueOfReserveMinimumReserve	camt.025	T2	VR01150	The currency code must be 'EUR'.	E102	Currency code not EUR	PrtryMsg/PrtryData/Data/T2PrtryData/NewMinRsrvValSet/Amt/Ccy	Rct/RctDtls/ReqHdIlg/StsCd	
camt.998_InsertValueOfReserveMinimumReserve	camt.025	T2	VR01161	The 'InsertValueOfMinimumReserve' message can only be sent for institutions subject to any kind of minimum reserve obligation (pool, indirect or direct).	E108	Institution not subject to minimum reserve obligation	PrtryMsg/PrtryData/Data/T2PrtryData/MinRsrvMgmtId/CtrPtyId/BIC	Rct/RctDtls/ReqHdIlg/StsCd	
camt.998_InsertValueOfReserveMinimum	camt.025	T2	VR01180	The indicated maintenance period must be the current or the next	E105	Invalid maintenance period	PrtryMsg/PrtryData/Data/T2PrtryData/NewMinRsrvValSe	Rct/RctDtls/ReqHdIlg/StsCd	

Fehler! Verwenden Sie die Registerkarte 'Start', um Index of validation rules and error codesHeadinq2Reference dem Text zuzuweisen. der hier

Inbound message type	Response message type	Rule source	Validation rule ID	Validation rule description	Error code	Error description	Xpaths of inbound message elements for validation	Xpath of response message code element	Source rule name
mReserve				one.			t/MntncPrd/FrDt PrtryMsg/PrtryData /Data/T2PrtryData/ NewMinRsrvValSe t/MntncPrd/ToDt		
camt.998_ModifyCreditLine	camt.025	T2	IV00290	The currency code must be a valid active currency code, not yet withdrawn on the day the message containing the currency is exchanged. Valid active currency codes are registered with the ISO 4217 Maintenance Agency, consist of three (3) contiguous letters, and are not yet withdrawn on the day the message containing the Currency is exchanged.	D005	Invalid active currency code in //Dynamic error including xpath//	PrtryMsg/PrtryData /Data/T2PrtryData/ NewCrdtLnValSet/ AmtWthCcy/Ccy	Rct/RctDtIs/ReqHd lg/Stscd	

Fehler! Verwenden Sie die Registerkarte 'Start', um dem Text zuzuweisen, der hier angezeigt werden soll.

Inbound message type	Response message type	Rule source	Validation rule ID	Validation rule description	Error code	Error description	Xpaths of inbound message elements for validation	Xpath of response message code element	Source rule name
camt.998_ModifyCreditLine	camt.025	T2	IV00310	The number of fractional digits (or minor unit of currency) must comply with ISO 4217. Note: The decimal separator is a dot.	D007	Invalid decimal digits for the specified currency in //Dynamic error including xpath//	PrtryMsg/PrtryData/Data/T2PrtryData/NewCrdtLnValSet/AmtWthCcy PrtryMsg/PrtryData/Data/T2PrtryData/NewCrdtLnValSet/AmtWthCcy/Ccy	Rct/RctDtls/ReqHd/Ig/StsCd	
camt.998_ModifyCreditLine	camt.025	T2	IV00320	Only a valid Business identifier code is allowed. Business identifier codes for financial or nonfinancial institutions are registered and published by the ISO 9362 Registration Authority in the ISO directory of BICs, and consists of eleven (11)	D008	Invalid financial or non-financial institution BIC in //Dynamic error including xpath//	PrtryMsg/PrtryData/Data/T2PrtryData/CrdtLnId/AcctOwnr	Rct/RctDtls/ReqHd/Ig/StsCd	

Fehler! Verwenden Sie die Registerkarte 'Start', um Index of validation rules and error codesHeadinq2Reference dem Text zuzuweisen. der hier

Inbound message type	Response message type	Rule source	Validation rule ID	Validation rule description	Error code	Error description	Xpaths of inbound message elements for validation	Xpath of response message code element	Source rule name
				contiguous characters.					
camt.998_ModifyCreditLine	camt.025	T2	VR00100	The business sender 'From' in the BAH must specify: Party BIC of responsible CB of party given in 'Account Owner' element in the payload.	E010	Invalid business sender	AppHdr/Fr/FlId/FinInstnId/BICFI PrtryMsg/PrtryData/Data/T2PrtryData/CrdtLnId/AcctOwnr	Rct/RctDtls/ReqHdIlg/StsCd	
camt.998_ModifyCreditLine	camt.025	T2	VR00120	The business receiver 'To' in the BAH must specify: The CLM system BIC.	E012	Invalid business receiver	AppHdr/To/FlId/FinInstnId/BICFI	Rct/RctDtls/ReqHdIlg/StsCd	
camt.998_ModifyCreditLine	camt.025	T2	VR01000	Account Owner must be a valid party BIC owning a valid default MCA for the indicated currency.	E085	Invalid AccountOwner	PrtryMsg/PrtryData/Data/T2PrtryData/CrdtLnId/AcctOwnr PrtryMsg/PrtryData/Data/T2PrtryData/NewCrdtLnValSet/AmtWthCcy/Ccy	Rct/RctDtls/ReqHdIlg/StsCd	

Fehler! Verwenden Sie die Registerkarte 'Start', um dem Text zuzuweisen, der hier angezeigt werden soll.

Inbound message type	Response message type	Rule source	Validation rule ID	Validation rule description	Error code	Error description	Xpaths of inbound message elements for validation	Xpath of response message code element	Source rule name
camt.998_ModifyCreditLine	camt.025	T2	VR01010	Sum of new delta and pending delta amount decreases must not exceed the current credit line.	E086	Sum of credit line decreases exceeds current credit line		Rct/RctDtls/ReqHdIlg/Stscd	
camt.998_ModifyCreditLine	camt.025	T2	VR01020	The pending fixed amount modification is rejected due to a new fixed or delta amount modification request or a settled connected payment. The pending delta amount modification is rejected due to a new fixed amount modification request.	E087	Pending modification rejected due to new request or connected payment		Rct/RctDtls/ReqHdIlg/Stscd	
camt.998_ModifyCreditLine	camt.025	T2	VR01240	A connected payment or a credit line modification	E099	Instruction not allowed after ECMS go-live	PrtryMsg/PrtryData/Data/T2PrtryData/	Rct/RctDtls/ReqHdIlg/Stscd	

Fehler! Verwenden Sie die Registerkarte 'Start', um Index of validation rules and error codesHeadinq2Reference dem Text zuzuweisen. der hier

Inbound message type	Response message type	Rule source	Validation rule ID	Validation rule description	Error code	Error description	Xpaths of inbound message elements for validation	Xpath of response message code element	Source rule name
e				with currency 'EUR' is not allowed by a CB after ECMS go-live.			NewCrdtLnValSet/ AmtWthCcy/Ccy		
pac.009	pac.002	T2	VR00070	'Instructing Agent' and 'Instructed Agent' must be known cash accounts in the addressed settlement service for the indicated currency.	E007	Account number / Account BIC in indicated currency unknown in addressed settlement service	FICdtTrf/CdtTrfTxlnf/InstgAgt/FinInstnId/BICFI FICdtTrf/CdtTrfTxlnf/InstdAgt/FinInstnId/BICFI FICdtTrf/CdtTrfTxlnf/IntrBkSttlmAmt/Ccy	FIToFIPmtStsRpt/TxInfAndSts/StsRsnInf/Rsn/Prtry	
pac.009	pac.002	T2	VR00100	The business sender 'From' in the BAH must specify: For RTGS: - for payment orders	E010	Invalid business sender	AppHdr/Fr/FIId/FinInstnId/BICFI FICdtTrf/CdtTrfTxlnf/InstgAgt/FinInstnId/BICFI FICdtTrf/CdtTrfTxlnf/IntrBkSttlmAmt/	FIToFIPmtStsRpt/TxInfAndSts/StsRsnInf/Rsn/Prtry	

Fehler! Verwenden Sie die Registerkarte 'Start', um dem Text zuzuweisen, der hier angezeigt werden soll.

Inbound message type	Response message type	Rule source	Validation rule ID	Validation rule description	Error code	Error description	Xpaths of inbound message elements for validation	Xpath of response message code element	Source rule name
				<p>(without code 'SBTI' in 'Local Instrument/Code') sent by the party itself: An Addressee BIC of the account given in 'Instructing Agent' element in the payload;</p> <p>- for payment orders (without code 'SBTI' in 'Local Instrument/Code') sent by the CB acting on behalf: Party BIC of responsible CB of owner of account given in 'Instructing Agent' element in the payload.</p> <p>- for liquidity transfer orders (only pacs.009 with code 'SBTI' in 'Local Instrument/Code') sent</p>			<p>Ccy</p> <p>Only relevant for RTGS: FICdtTrf/CdtTrfTxlnf/PmtTpInf/LclInstm/Cd</p>		

Fehler! Verwenden Sie die Registerkarte 'Start', um Index of validation rules and error codes dem Text zuzuweisen. der hier

Inbound message type	Response message type	Rule source	Validation rule ID	Validation rule description	Error code	Error description	Xpaths of inbound message elements for validation	Xpath of response message code element	Source rule name
				<p>by the party itself: Party BIC of owner of account given in 'Instructing Agent' element in the payload;</p> <p>- for liquidity transfer orders (only pacs.009 with code 'SBTI' in 'Local Instrument/Code') sent by the CB acting on behalf: Party BIC of responsible CB of owner of account given in 'Instructing Agent' element in the payload;</p> <p>For CLM: Party BIC of owner of account given in</p>					

Fehler! Verwenden Sie die Registerkarte 'Start', um dem Text zuzuweisen, der hier angezeigt werden soll.

Inbound message type	Response message type	Rule source	Validation rule ID	Validation rule description	Error code	Error description	Xpaths of inbound message elements for validation	Xpath of response message code element	Source rule name
				'Instructing Agent' element in the payload.					
pacs.009	pacs.002	T2	VR00101	The business sender must be a CB.	E028	Business sender must be a CB	AppHdr/Fr/FlId/FinInstnId/BICFI	FIToFIPmtStsRpt/TxInfAndSts/StsRsnInf/Rsn/Prtry	
pacs.009	pacs.002	T2	VR00120	The business receiver 'To' in the BAH must specify: For RTGS: - for payment orders (without code 'SBTI' in 'Local Instrument/Code'): An Addressee BIC of the account given in 'Instructed Agent' element in the payload. - for liquidity transfer orders (with code 'SBTI'	E012	Invalid business receiver	AppHdr/To/FlId/FinInstnId/BICFI + For RTGS: FICdtTrf/CdtTrfTxlnf/InstAgt/FinInstnId/BICFI FICdtTrf/CdtTrfTxlnf/IntrBkSttlmAmt/Ccy	FIToFIPmtStsRpt/TxInfAndSts/StsRsnInf/Rsn/Prtry	

Fehler! Verwenden Sie die Registerkarte 'Start', um Index of validation rules and error codesHeadinq2Reference dem Text zuzuweisen. der hier

Inbound message type	Response message type	Rule source	Validation rule ID	Validation rule description	Error code	Error description	Xpaths of inbound message elements for validation	Xpath of response message code element	Source rule name
				in 'Local Instrument/Code'): The RTGS system BIC. For CLM: The CLM system BIC.					
pacs.009	pacs.002	T2	VR00150	A payment order with the following identical field content in the defined timeframe is a duplicate: - instructing agent; - message type; - instructed agent; - UETR; - end to end identification; - settlement date; - settlement amount.	E015	Duplicate message payload	FICdtTrf/CdtTrfTxlnf/InstgAgt/FinInstnld/BICFI AppHdr/MsgDefldr FICdtTrf/CdtTrfTxlnf/InstdAgt/FinInstnld/BICFI FICdtTrf/CdtTrfTxlnf/Pmtld/UETR FICdtTrf/CdtTrfTxlnf/Pmtld/EndToEndld FICdtTrf/CdtTrfTxlnf/Pmtld/EndToEndld	FIToFIPmtStsRpt/TxInfAndSts/StsRsnInf/Rsn/Prtry	

Fehler! Verwenden Sie die Registerkarte 'Start', um dem Text zuzuweisen, der hier angezeigt werden soll.

Inbound message type	Response message type	Rule source	Validation rule ID	Validation rule description	Error code	Error description	Xpaths of inbound message elements for validation	Xpath of response message code element	Source rule name
							nf/IntrBkSttlmDt FICdtTrf/CdtTrfTxl nf/IntrBkSttlmAmt		
pacs.009	pacs.002	T2	VR00170	For RTGS: A settlement date in the past is only allowed when the value date check is disabled for the instructing RTGS Account Holder. For CLM: A settlement date in the past is not allowed.	E016	Past settlement date not allowed	FICdtTrf/CdtTrfTxl nf/IntrBkSttlmDt FICdtTrf/CdtTrfTxl nf/InstgAgt/FinInstnId/BICFI FICdtTrf/CdtTrfTxl nf/IntrBkSttlmAmt/Ccy	FIToFIPmtStsRpt/TxInfAndSts/StsRsnInf/Rsn/Prtry	
pacs.009	pacs.002	T2	VR00180	Warehoused payments can be sent for a business day for the specified currency up to the defined number of	E017	Settlement date greater than latest submission date for warehoused payments or not a valid business day	FICdtTrf/CdtTrfTxl nf/IntrBkSttlmDt FICdtTrf/CdtTrfTxl nf/IntrBkSttlmAmt/Ccy	FIToFIPmtStsRpt/TxInfAndSts/StsRsnInf/Rsn/Prtry	

Fehler! Verwenden Sie die Registerkarte 'Start', um Index of validation rules and error codesHeadinq2Reference dem Text zuzuweisen. der hier

Inbound message type	Response message type	Rule source	Validation rule ID	Validation rule description	Error code	Error description	Xpaths of inbound message elements for validation	Xpath of response message code element	Source rule name
				calendar days in the future.					
pacs.009	pacs.002	T2	VR00210	<p>From time, till time and reject time must be within the relevant settlement window in this currency</p> <p>For CLM: Settlement window for CBOs.</p> <p>For RTGS: pacs.008: Settlement window for customer payments pacs.009 and pacs.010: Settlement window for interbank payments.</p>	E019	From time, till time or reject time outside of settlement window	<p>FICdtTrf/CdtTrfTxlnf/SttImTmReq/FrTm</p> <p>FICdtTrf/CdtTrfTxlnf/SttImTmReq/TillTm</p> <p>FICdtTrf/CdtTrfTxlnf/SttImTmReq/RjctTm</p> <p>FICdtTrf/CdtTrfTxlnf/IntrBkSttImAmt/Ccy</p>	FIToFIPmtStsRpt/TxInfAndSts/StsRsnInf/Rsn/Prtry	
pacs.009	pacs.002	T2	VR00230	From time must be before latest debit time	E021	From time after latest debit time (reject time or	FICdtTrf/CdtTrfTxlnf/SttImTmReq/FrTm	FIToFIPmtStsRpt/TxInfAndSts/StsRsn	

Fehler! Verwenden Sie die Registerkarte 'Start', um dem Text zuzuweisen, der hier angezeigt werden soll.

Inbound message type	Response message type	Rule source	Validation rule ID	Validation rule description	Error code	Error description	Xpaths of inbound message elements for validation	Xpath of response message code element	Source rule name
				(reject time or till time).		till time)	m FICdtTrf/CdtTrfTxl nf/StlmTmReq/Till Tm FICdtTrf/CdtTrfTxl nf/StlmTmReq/Rjc tTm	nInf/Rsn/Prtry	
pacs.009	pacs.002	T2	VR00231	All timeshifts for from time and latest debit time (reject time or till time) must be identical.	E093	Invalid timeshifts	FICdtTrf/CdtTrfTxl nf/StlmTmReq/FrT m FICdtTrf/CdtTrfTxl nf/StlmTmReq/Till Tm FICdtTrf/CdtTrfTxl nf/StlmTmReq/Rjc tTm	FIToFIPmtStsRpt/ TxInfAndSts/StsRs nInf/Rsn/Prtry	
pacs.009	pacs.002	T2	VR00240	For payment orders with settlement date equal to the current business day or in the past, the till time	E022	Till time or reject time earlier than current system time	FIToFICstmrCdtTrf /CdtTrfTxlInf/IntrBk StlmDt FICdtTrf/CdtTrfTxl	FIToFIPmtStsRpt/ TxInfAndSts/StsRs nInf/Rsn/Prtry	

Fehler! Verwenden Sie die Registerkarte 'Start', um Index of validation rules and error codesHeadinq2Reference dem Text zuzuweisen. der hier

Inbound message type	Response message type	Rule source	Validation rule ID	Validation rule description	Error code	Error description	Xpaths of inbound message elements for validation	Xpath of response message code element	Source rule name
				and reject time must be after the current system time.			nf/SttlmTmReq/TillTm FICdtTrf/CdtTrfTxlnf/SttlmTmReq/RjctTm		
pacs.009	pacs.002	T2	VR00251	The payment order is rejected due to reach of reject time.	E076	Reject time reached		FIToFIPmtStsRpt/TxInfAndSts/StsRsnInf/Rsn/Prtry	
pacs.009	pacs.002	T2	VR00252	At least one of the impacted parties or accounts is blocked. The earmarked cash transfer order has been disagreed by the respective CB/OT.	E023	Central bank disagreed to earmarked cash transfer order		FIToFIPmtStsRpt/TxInfAndSts/StsRsnInf/Rsn/Prtry	
pacs.009	pacs.002	T2	VR00270	For RTGS: The instructing agent must be a valid RTGS DCA, RTGS CB account	E013	Invalid account type for InstructingAgent (pacs) or DebtorAccount (camt)	FICdtTrf/CdtTrfTxlnf/InstgAgt/FinInstnId/BICFI	FIToFIPmtStsRpt/TxInfAndSts/StsRsnInf/Rsn/Prtry	

Fehler! Verwenden Sie die Registerkarte 'Start', um dem Text zuzuweisen, der hier angezeigt werden soll.

Inbound message type	Response message type	Rule source	Validation rule ID	Validation rule description	Error code	Error description	Xpaths of inbound message elements for validation	Xpath of response message code element	Source rule name
				or AS guarantee funds account. For CLM: The instructing agent must be a valid CLM CB account.					
pac.009	pac.002	T2	VR00280	The instructing agent and the instructed agent must be different.	E096	InstructingAgent and InstructedAgent must be different	FICdtTrf/CdtTrfTxlnf/InstdAgt/FinInstnId/BICFI FICdtTrf/CdtTrfTxlnf/InstgAgt/FinInstnId/BICFI	FIToFIPmtStsRpt/TxInfAndSts/StsRsnInf/Rsn/Prtry	
pac.009	pac.002	T2	VR00290	For RTGS: The instructed agent must be a valid RTGS DCA, RTGS CB account or AS guarantee funds account, if code 'SBTI' is	E014	Invalid account type for InstructedAgent (pac) or CreditorAccount (camt)	FICdtTrf/CdtTrfTxlnf/InstdAgt/FinInstnId/BICFI FICdtTrf/CdtTrfTxlnf/PmtTpInf/LclInstm/Cd	FIToFIPmtStsRpt/TxInfAndSts/StsRsnInf/Rsn/Prtry	

Fehler! Verwenden Sie die Registerkarte 'Start', um Index of validation rules and error codesHeadinq2Reference dem Text zuzuweisen. der hier

Inbound message type	Response message type	Rule source	Validation rule ID	Validation rule description	Error code	Error description	Xpaths of inbound message elements for validation	Xpath of response message code element	Source rule name
				not used in Local Instrument/Code (relevant for pacs.009 only). For CLM: The instructed agent must be a valid MCA or CLM CB account.					
pacs.009	pacs.002	T2	VR00310	If code 'BLKD' (only relevant for pacs.010) or 'CONP' is used in Local Instrument/Proprietary, no reject time is allowed.	E025	Reject time not allowed for this cash transfer type	FICdtTrf/CdtTrfTxlnf/PmtTpInf/LclInstm/Prtry FICdtTrf/CdtTrfTxlnf/StlmTmReq/RjctTm	FIToFIPmtStsRpt/TxInfAndSts/StsRsnInf/Rsn/Prtry	
pacs.009	pacs.002	T2	VR00320	In case of a connected payment: - the instructed agent must be an MCA;	E026	Connected payment not allowed	FICdtTrf/CdtTrfTxlnf/PmtTpInf/LclInstm/Prtry FICdtTrf/CdtTrfTxlnf/InstAgf/FinInst	FIToFIPmtStsRpt/TxInfAndSts/StsRsnInf/Rsn/Prtry	

Fehler! Verwenden Sie die Registerkarte 'Start', um dem Text zuzuweisen, der hier angezeigt werden soll.

Inbound message type	Response message type	Rule source	Validation rule ID	Validation rule description	Error code	Error description	Xpaths of inbound message elements for validation	Xpath of response message code element	Source rule name
				- the instructing agent must be a CLM CB account; - both accounts must have the same responsible CB.			nId/BICFI FICdtTrf/CdtTrfTxlnf/InstgAgt/FinInstnId/BICFI		
pacs.009	pacs.002	T2	VR00330	If code 'CONP' is used in Local Instrument/Proprietary, the code has to be followed by a '/' and a positive amount with maximum 18 numeric characters including mandatory decimal point and 0 to 2 decimal places.	E027	Code 'CONP' not followed by a valid amount	FICdtTrf/CdtTrfTxlnf/PmtTpInf/LclInstm/Prtry	FIToFIPmtStsRpt/TxInfAndSts/StsRsnInf/Rsn/Prtry	
pacs.009	pacs.002	T2	VR00340	Code 'BLKD' in Local Instrument/Proprietary is	E029	Code 'BLKD' not allowed	FICdtTrf/CdtTrfTxlnf/PmtTpInf/LclInst	FIToFIPmtStsRpt/TxInfAndSts/StsRs	

Fehler! Verwenden Sie die Registerkarte 'Start', um Index of validation rules and error codesHeadinq2Reference dem Text zuzuweisen. der hier

Inbound message type	Response message type	Rule source	Validation rule ID	Validation rule description	Error code	Error description	Xpaths of inbound message elements for validation	Xpath of response message code element	Source rule name
				not allowed.			rm/Prtry	nInf/Rsn/Prtry	
pac.009	pac.002	T2	VR00840	The cash transfer order has been revoked.	E067	Cash transfer order revoked		FIToFIPmtStsRpt/TxInfAndSts/StsRsnInf/Rsn/Prtry	
pac.009	pac.002	T2	VR01110	For a connected payment decreasing the liquidity, no delta credit line modifications must be pending for the same MCA.	E101	Connected payment not accepted due to pending delta credit line modifications		FIToFIPmtStsRpt/TxInfAndSts/StsRsnInf/Rsn/Prtry	
pac.009	pac.002	T2	VR01120	For a connected payment decreasing the liquidity, the MCA must have sufficient liquidity. For a connected payment debiting the CB account, the CB account must be not credit-based only or must have	E042	Insufficient liquidity		FIToFIPmtStsRpt/TxInfAndSts/StsRsnInf/Rsn/Prtry	

Fehler! Verwenden Sie die Registerkarte 'Start', um dem Text zuzuweisen, der hier angezeigt werden soll.

Inbound message type	Response message type	Rule source	Validation rule ID	Validation rule description	Error code	Error description	Xpaths of inbound message elements for validation	Xpath of response message code element	Source rule name
				sufficient liquidity.					
pacs.009	pacs.002	T2	VR01130	For a connected payment, the sum of the credit line part and pending delta amount decreases must not exceed the current credit line.	E086	Sum of credit line decreases exceeds current credit line		FIToFIPmtStsRpt/TxInfAndSts/StsRsnInf/Rsn/Prtry	
pacs.009	pacs.002	T2	VR01240	A connected payment or a credit line modification with currency 'EUR' is not allowed by a CB after ECMS go-live.	E099	Instruction not allowed after ECMS go-live	FICdtTrf/CdtTrfTxlnf/PmtTpInf/LclInstm/Prtry FICdtTrf/CdtTrfTxlnf/IntrBkSttlmAmt/Ccy	FIToFIPmtStsRpt/TxInfAndSts/StsRsnInf/Rsn/Prtry	
pacs.009	pacs.002	ISO	IV00290	The currency code must be a valid active currency code, not yet withdrawn on the day the message containing the currency	D005	Invalid active currency code in //Dynamic error including xpath//	FICdtTrf/CdtTrfTxlnf/IntrBkSttlmAmt/Ccy FICdtTrf/CdtTrfTxlnf/UndrlygCstmrCd	FIToFIPmtStsRpt/TxInfAndSts/StsRsnInf/Rsn/Prtry	ActiveCurrency

Fehler! Verwenden Sie die Registerkarte 'Start', um Index of validation rules and error codes dem Text zuzuweisen. der hier

Inbound message type	Response message type	Rule source	Validation rule ID	Validation rule description	Error code	Error description	Xpaths of inbound message elements for validation	Xpath of response message code element	Source rule name
				is exchanged. Valid active currency codes are registered with the ISO 4217 Maintenance Agency, consist of three (3) contiguous letters, and are not yet withdrawn on the day the message containing the Currency is exchanged.			tTrf/CdtrAcct/Ccy FICdtTrf/CdtTrfTxlnf/UndrlygCstmrCd tTrf/CdtrAgtAcct/Ccy FICdtTrf/CdtTrfTxlnf/UndrlygCstmrCd tTrf/IntrmyAgt3Acct/Ccy FICdtTrf/CdtTrfTxlnf/UndrlygCstmrCd tTrf/IntrmyAgt2Acct/Ccy FICdtTrf/CdtTrfTxlnf/UndrlygCstmrCd tTrf/IntrmyAgt1Acct/Ccy FICdtTrf/CdtTrfTxlnf/UndrlygCstmrCd		

Fehler! Verwenden Sie die Registerkarte 'Start', um dem Text zuzuweisen, der hier angezeigt werden soll.

Inbound message type	Response message type	Rule source	Validation rule ID	Validation rule description	Error code	Error description	Xpaths of inbound message elements for validation	Xpath of response message code element	Source rule name
							tTrf/PrvsInstgAgt3 Acct/Ccy FICdtTrf/CdtTrfTxlnf/UndrlygCstmrCd tTrf/PrvsInstgAgt2 Acct/Ccy FICdtTrf/CdtTrfTxlnf/UndrlygCstmrCd tTrf/PrvsInstgAgt1 Acct/Ccy FICdtTrf/CdtTrfTxlnf/UndrlygCstmrCd tTrf/DbtrAgtAcct/Ccy FICdtTrf/CdtTrfTxlnf/UndrlygCstmrCd tTrf/DbtrAcct/Ccy FICdtTrf/CdtTrfTxlnf/CdtrAcct/Ccy		

Fehler! Verwenden Sie die Registerkarte 'Start', um Index of validation rules and error codesHeadinq2Reference dem Text zuzuweisen. der hier

Inbound message type	Response message type	Rule source	Validation rule ID	Validation rule description	Error code	Error description	Xpaths of inbound message elements for validation	Xpath of response message code element	Source rule name
							FICdtTrf/CdtTrfTxlnf/CdtrAgtAcct/Ccy		
							FICdtTrf/CdtTrfTxlnf/DbtrAgtAcct/Ccy		
							FICdtTrf/CdtTrfTxlnf/DbtrAcct/Ccy		
							FICdtTrf/CdtTrfTxlnf/IntrmyAgt3Acct/Ccy		
							FICdtTrf/CdtTrfTxlnf/IntrmyAgt2Acct/Ccy		
							FICdtTrf/CdtTrfTxlnf/IntrmyAgt1Acct/Ccy		
							FICdtTrf/CdtTrfTxlnf/PrvsInstgAgt3Acct/Ccy		

Fehler! Verwenden Sie die Registerkarte 'Start', um dem Text zuzuweisen, der hier angezeigt werden soll.

Inbound message type	Response message type	Rule source	Validation rule ID	Validation rule description	Error code	Error description	Xpaths of inbound message elements for validation	Xpath of response message code element	Source rule name
							FICdtTrf/CdtTrfTxlnf/PrvsInstgAgt2Account/Ccy FICdtTrf/CdtTrfTxlnf/PrvsInstgAgt1Account/Ccy FICdtTrf/CdtTrfTxlnf/UndrlygCstmrtTrf/InstdAmt/Ccy FICdtTrf/CdtTrfTxlnf/UndrlygCstmrtTrf/RmtInf/Strd/GrnshmtRmt/RmtAmt/Ccy FICdtTrf/CdtTrfTxlnf/UndrlygCstmrtTrf/RmtInf/Strd/TaxRmt/Rcrd/TaxAmt/Dtls/Amt/Ccy		

Fehler! Verwenden Sie die Registerkarte 'Start', um Index of validation rules and error codesHeadinq2Reference dem Text zuzuweisen. der hier

Inbound message type	Response message type	Rule source	Validation rule ID	Validation rule description	Error code	Error description	Xpaths of inbound message elements for validation	Xpath of response message code element	Source rule name
							FICdtTrf/CdtTrfTxlnf/UndrlygCstmrCd tTrf/RmtInf/Strd/TaxRmt/Rcrd/TaxAmt/TtlAmt/Ccy		
							FICdtTrf/CdtTrfTxlnf/UndrlygCstmrCd tTrf/RmtInf/Strd/TaxRmt/Rcrd/TaxAmt/TaxblBaseAmt/Ccy		
							FICdtTrf/CdtTrfTxlnf/UndrlygCstmrCd tTrf/RmtInf/Strd/TaxRmt/TtlTaxAmt/Ccy		
							FICdtTrf/CdtTrfTxlnf/UndrlygCstmrCd tTrf/RmtInf/Strd/Ta		

Fehler! Verwenden Sie die Registerkarte 'Start', um dem Text zuzuweisen, der hier angezeigt werden soll.

Inbound message type	Response message type	Rule source	Validation rule ID	Validation rule description	Error code	Error description	Xpaths of inbound message elements for validation	Xpath of response message code element	Source rule name
							xRmt/TtTaxblBase Amt/Ccy FICdtTrf/CdtTrfTxl nf/UndrlygCstmrCd tTrf/RmtInf/Strd/Rfr dDocAmt/RmtdAmt /Ccy FICdtTrf/CdtTrfTxl nf/UndrlygCstmrCd tTrf/RmtInf/Strd/Rfr dDocAmt/Adjstmnt AmtAndRsn/Amt/C cy FICdtTrf/CdtTrfTxl nf/UndrlygCstmrCd tTrf/RmtInf/Strd/Rfr dDocAmt/TaxAmt/ Amt/Ccy FICdtTrf/CdtTrfTxl		

Fehler! Verwenden Sie die Registerkarte 'Start', um Index of validation rules and error codes dem Text zuzuweisen. der hier

Inbound message type	Response message type	Rule source	Validation rule ID	Validation rule description	Error code	Error description	Xpaths of inbound message elements for validation	Xpath of response message code element	Source rule name
							nf/UndrlygCstmrCd tTrf/RmtInf/Strd/Rfr dDocAmt/CdtNote Amt/Ccy FICdtTrf/CdtTrfTxl nf/UndrlygCstmrCd tTrf/RmtInf/Strd/Rfr dDocAmt/DscntApl dAmt/Amt/Ccy FICdtTrf/CdtTrfTxl nf/UndrlygCstmrCd tTrf/RmtInf/Strd/Rfr dDocAmt/DuePybl Amt/Ccy FICdtTrf/CdtTrfTxl nf/UndrlygCstmrCd tTrf/RmtInf/Strd/Rfr dDocInf/LineDtls/A mt/RmtdAmt/Ccy		

Fehler! Verwenden Sie die Registerkarte 'Start', um dem Text zuzuweisen, der hier angezeigt werden soll.

Inbound message type	Response message type	Rule source	Validation rule ID	Validation rule description	Error code	Error description	Xpaths of inbound message elements for validation	Xpath of response message code element	Source rule name
							FICdtTrf/CdtTrfTxlnf/UndrlygCstmrCdtTrf/RmtInf/Strd/RfrdDocInf/LineDtls/Amt/AdjstmntAmtAndRsn/Amt/Ccy FICdtTrf/CdtTrfTxlnf/UndrlygCstmrCdtTrf/RmtInf/Strd/RfrdDocInf/LineDtls/Amt/TaxAmt/Amt/Ccy FICdtTrf/CdtTrfTxlnf/UndrlygCstmrCdtTrf/RmtInf/Strd/RfrdDocInf/LineDtls/Amt/CdtNoteAmt/Ccy FICdtTrf/CdtTrfTxlnf/UndrlygCstmrCdtTrf/RmtInf/Strd/RfrdDocInf/LineDtls/Amt/CdtNoteAmt/Ccy		

Fehler! Verwenden Sie die Registerkarte 'Start', um Index of validation rules and error codesHeadinq2Reference dem Text zuzuweisen. der hier

Inbound message type	Response message type	Rule source	Validation rule ID	Validation rule description	Error code	Error description	Xpaths of inbound message elements for validation	Xpath of response message code element	Source rule name
							nf/UndrlygCstmrCd tTrf/RmtInf/Strd/Rfr dDocInf/LineDtls/A mt/DscntApldAmt/ Amt/Ccy FICdtTrf/CdtTrfTxl nf/UndrlygCstmrCd tTrf/RmtInf/Strd/Rfr dDocInf/LineDtls/A mt/DuePyblAmt/Cc y		
pacs.009	pacs.002	ISO	IV00310	The number of fractional digits (or minor unit of currency) must comply with ISO 4217. Note: The decimal separator is a dot.	D007	Invalid decimal digits for the specified currency in //Dynamic error including xpath//	FICdtTrf/CdtTrfTxl nf/UndrlygCstmrCd tTrf/InstdAmt FICdtTrf/CdtTrfTxl nf/UndrlygCstmrCd tTrf/RmtInf/Strd/Gr nshmtRmt/RmtdA mt	FIToFIPmtStsRpt/ TxInfAndSts/StsRs nInf/Rsn/Prtry	CurrencyAmount

Fehler! Verwenden Sie die Registerkarte 'Start', um dem Text zuzuweisen, der hier angezeigt werden soll.

Inbound message type	Response message type	Rule source	Validation rule ID	Validation rule description	Error code	Error description	Xpaths of inbound message elements for validation	Xpath of response message code element	Source rule name
							FICdtTrf/CdtTrfTxlnf/UndrlygCstmrCd tTrf/RmtInf/Strd/TaxRmt/Rcrd/TaxAmt/Dtls/Amt		
							FICdtTrf/CdtTrfTxlnf/UndrlygCstmrCd tTrf/RmtInf/Strd/TaxRmt/Rcrd/TaxAmt/TtlAmt		
							FICdtTrf/CdtTrfTxlnf/UndrlygCstmrCd tTrf/RmtInf/Strd/TaxRmt/Rcrd/TaxAmt/TaxblBaseAmt		
							FICdtTrf/CdtTrfTxlnf/UndrlygCstmrCd tTrf/RmtInf/Strd/TaxRmt/TtlTaxAmt		

Fehler! Verwenden Sie die Registerkarte 'Start', um Index of validation rules and error codesHeadinq2Reference dem Text zuzuweisen. der hier

Inbound message type	Response message type	Rule source	Validation rule ID	Validation rule description	Error code	Error description	Xpaths of inbound message elements for validation	Xpath of response message code element	Source rule name
							FICdtTrf/CdtTrfTxlnf/UndrlygCstmrCd tTrf/RmtInf/Strd/TaxRmt/TtlTaxblBase Amt		
							FICdtTrf/CdtTrfTxlnf/UndrlygCstmrCd tTrf/RmtInf/Strd/Rfr dDocAmt/RmtdAmt		
							FICdtTrf/CdtTrfTxlnf/UndrlygCstmrCd tTrf/RmtInf/Strd/Rfr dDocAmt/Adjstmnt AmtAndRsn/Amt		
							FICdtTrf/CdtTrfTxlnf/UndrlygCstmrCd tTrf/RmtInf/Strd/Rfr dDocAmt/TaxAmt/ Amt		

Fehler! Verwenden Sie die Registerkarte 'Start', um dem Text zuzuweisen, der hier angezeigt werden soll.

Inbound message type	Response message type	Rule source	Validation rule ID	Validation rule description	Error code	Error description	Xpaths of inbound message elements for validation	Xpath of response message code element	Source rule name
							FICdtTrf/CdtTrfTxlnf/UndrlygCstmrcdtTrf/RmtInf/Strd/RfrdDocAmt/CdtNoteAmt		
							FICdtTrf/CdtTrfTxlnf/UndrlygCstmrcdtTrf/RmtInf/Strd/RfrdDocAmt/DscntApldAmt/Amt		
							FICdtTrf/CdtTrfTxlnf/UndrlygCstmrcdtTrf/RmtInf/Strd/RfrdDocAmt/DuePyblAmt		
							FICdtTrf/CdtTrfTxlnf/UndrlygCstmrcdtTrf/RmtInf/Strd/RfrdDocInf/LineDtIs/A		

Fehler! Verwenden Sie die Registerkarte 'Start', um Index of validation rules and error codes dem Text zuzuweisen. der hier

Inbound message type	Response message type	Rule source	Validation rule ID	Validation rule description	Error code	Error description	Xpaths of inbound message elements for validation	Xpath of response message code element	Source rule name
							mt/RmtdAmt FICdtTrf/CdtTrfTxlnf/UndrlygCstmrcdtTrf/Rmtlnf/Strd/RfrdDoclnf/LineDtls/Amt/AdjstmntAmtAndRsn/Amt FICdtTrf/CdtTrfTxlnf/UndrlygCstmrcdtTrf/Rmtlnf/Strd/RfrdDoclnf/LineDtls/Amt/TaxAmt/Amt FICdtTrf/CdtTrfTxlnf/UndrlygCstmrcdtTrf/Rmtlnf/Strd/RfrdDoclnf/LineDtls/Amt/CdtNoteAmt FICdtTrf/CdtTrfTxlnf/UndrlygCstmrcd		

Fehler! Verwenden Sie die Registerkarte 'Start', um dem Text zuzuweisen, der hier angezeigt werden soll.

Inbound message type	Response message type	Rule source	Validation rule ID	Validation rule description	Error code	Error description	Xpaths of inbound message elements for validation	Xpath of response message code element	Source rule name
							tTrf/RmtInf/Strd/Rfr dDocInf/LineDtls/A mt/DscntApldAmt/ Amt FICdtTrf/CdtTrfTxl nf/UndrlygCstmrCd tTrf/RmtInf/Strd/Rfr dDocInf/LineDtls/A mt/DuePyblAmt FICdtTrf/CdtTrfTxl nf/IntrBkSttlmAmt FICdtTrf/CdtTrfTxl nf/UndrlygCstmrCd tTrf/InstdAmt/Ccy FICdtTrf/CdtTrfTxl nf/UndrlygCstmrCd tTrf/RmtInf/Strd/Gr nshmtRmt/RmtdA mt/Ccy		

Fehler! Verwenden Sie die Registerkarte 'Start', um Index of validation rules and error codes dem Text zuzuweisen. der hier

Inbound message type	Response message type	Rule source	Validation rule ID	Validation rule description	Error code	Error description	Xpaths of inbound message elements for validation	Xpath of response message code element	Source rule name
							FICdtTrf/CdtTrfTxlnf/UndrlygCstmrCd tTrf/RmtInf/Strd/TaxRmt/Rcrd/TaxAmt/Dtls/Amt/Ccy		
							FICdtTrf/CdtTrfTxlnf/UndrlygCstmrCd tTrf/RmtInf/Strd/TaxRmt/Rcrd/TaxAmt/TtlAmt/Ccy		
							FICdtTrf/CdtTrfTxlnf/UndrlygCstmrCd tTrf/RmtInf/Strd/TaxRmt/Rcrd/TaxAmt/TaxblBaseAmt/Ccy		
							FICdtTrf/CdtTrfTxlnf/UndrlygCstmrCd tTrf/RmtInf/Strd/Ta		

Fehler! Verwenden Sie die Registerkarte 'Start', um dem Text zuzuweisen, der hier angezeigt werden soll.

Inbound message type	Response message type	Rule source	Validation rule ID	Validation rule description	Error code	Error description	Xpaths of inbound message elements for validation	Xpath of response message code element	Source rule name
							xRmt/TtTaxAmt/Ccy FICdtTrf/CdtTrfTxlnf/UndrlygCstmrCd tTrf/RmtInf/Strd/TaxRmt/TtTaxblBaseAmt/Ccy FICdtTrf/CdtTrfTxlnf/UndrlygCstmrCd tTrf/RmtInf/Strd/RfrdDocAmt/RmdAmt/Ccy FICdtTrf/CdtTrfTxlnf/UndrlygCstmrCd tTrf/RmtInf/Strd/RfrdDocAmt/AdjstmntAmtAndRsn/Amt/Ccy FICdtTrf/CdtTrfTxlnf/UndrlygCstmrCd		

Fehler! Verwenden Sie die Registerkarte 'Start', um Index of validation rules and error codesHeadinq2Reference dem Text zuzuweisen. der hier

Inbound message type	Response message type	Rule source	Validation rule ID	Validation rule description	Error code	Error description	Xpaths of inbound message elements for validation	Xpath of response message code element	Source rule name
							nf/UndrlygCstmrCd tTrf/RmtInf/Strd/Rfr dDocAmt/TaxAmt/ Amt/Ccy FICdtTrf/CdtTrfTxl nf/UndrlygCstmrCd tTrf/RmtInf/Strd/Rfr dDocAmt/CdtNote Amt/Ccy FICdtTrf/CdtTrfTxl nf/UndrlygCstmrCd tTrf/RmtInf/Strd/Rfr dDocAmt/DscntApl dAmt/Amt/Ccy FICdtTrf/CdtTrfTxl nf/UndrlygCstmrCd tTrf/RmtInf/Strd/Rfr dDocAmt/DuePybl Amt/Ccy		

Fehler! Verwenden Sie die Registerkarte 'Start', um dem Text zuzuweisen, der hier angezeigt werden soll.

Inbound message type	Response message type	Rule source	Validation rule ID	Validation rule description	Error code	Error description	Xpaths of inbound message elements for validation	Xpath of response message code element	Source rule name
							FICdtTrf/CdtTrfTxlnf/UndrlygCstmrCd tTrf/RmtInf/Strd/Rfr dDocInf/LineDtls/A mt/RmtdAmt/Ccy		
							FICdtTrf/CdtTrfTxlnf/UndrlygCstmrCd tTrf/RmtInf/Strd/Rfr dDocInf/LineDtls/A mt/AdjstmntAmtAn dRsn/Amt/Ccy		
							FICdtTrf/CdtTrfTxlnf/UndrlygCstmrCd tTrf/RmtInf/Strd/Rfr dDocInf/LineDtls/A mt/TaxAmt/Amt/Cc y		
							FICdtTrf/CdtTrfTxlnf/UndrlygCstmrCd		

Fehler! Verwenden Sie die Registerkarte 'Start', um Index of validation rules and error codes dem Text zuzuweisen. der hier

Inbound message type	Response message type	Rule source	Validation rule ID	Validation rule description	Error code	Error description	Xpaths of inbound message elements for validation	Xpath of response message code element	Source rule name
							tTrf/RmtInf/Strd/Rfr dDocInf/LineDtls/A mt/CdtNoteAmt/Cc y FICdtTrf/CdtTrfTxl nf/UndrlygCstmrCd tTrf/RmtInf/Strd/Rfr dDocInf/LineDtls/A mt/DscntApldAmt/ Amt/Ccy FICdtTrf/CdtTrfTxl nf/UndrlygCstmrCd tTrf/RmtInf/Strd/Rfr dDocInf/LineDtls/A mt/DuePyblAmt/Cc y FICdtTrf/CdtTrfTxl nf/IntrBkSttlmAmt/ Ccy		

Fehler! Verwenden Sie die Registerkarte 'Start', um dem Text zuzuweisen, der hier angezeigt werden soll.

Inbound message type	Response message type	Rule source	Validation rule ID	Validation rule description	Error code	Error description	Xpaths of inbound message elements for validation	Xpath of response message code element	Source rule name
pac.009	pac.002	ISO	IV00320	Only a valid Business identifier code is allowed. Business identifier codes for financial or nonfinancial institutions are registered and published by the ISO 9362 Registration Authority in the ISO directory of BICs, and consists of eleven (11) contiguous characters.	D008	Invalid financial or non-financial institution BIC in //Dynamic error including xpath//	FICdtTrf/CdtTrfTxlnf/UndrlygCstmrCd tTrf/RmtInf/Strd/GrnshmtRmt/GrnshmtAdmstr/Id/OrgId/AnyBIC FICdtTrf/CdtTrfTxlnf/UndrlygCstmrCd tTrf/RmtInf/Strd/GrnshmtRmt/Grnshee/Id/OrgId/AnyBIC FICdtTrf/CdtTrfTxlnf/UndrlygCstmrCd tTrf/RmtInf/Strd/Invcee/Id/OrgId/AnyBIC FICdtTrf/CdtTrfTxlnf/UndrlygCstmrCd tTrf/RmtInf/Strd/Inv	FIToFIPmtStsRpt/TxInfAndSts/StsRsnInf/Rsn/Prtry	AnyBIC

Fehler! Verwenden Sie die Registerkarte 'Start', um Index of validation rules and error codes dem Text zuzuweisen. der hier

Inbound message type	Response message type	Rule source	Validation rule ID	Validation rule description	Error code	Error description	Xpaths of inbound message elements for validation	Xpath of response message code element	Source rule name
							cr/Id/OrgId/AnyBIC FICdtTrf/CdtTrfTxlnf/UndrlygCstmrcdtTrf/UltmtCdtr/Id/OrgId/AnyBIC FICdtTrf/CdtTrfTxlnf/UndrlygCstmrcdtTrf/Cdtr/Id/OrgId/AnyBIC FICdtTrf/CdtTrfTxlnf/UndrlygCstmrcdtTrf/Dbtr/Id/OrgId/AnyBIC FICdtTrf/CdtTrfTxlnf/UndrlygCstmrcdtTrf/InitgPty/Id/OrgId/AnyBIC FICdtTrf/CdtTrfTxlnf/UndrlygCstmrcdtTrf/InitgPty/Id/OrgId/AnyBIC		

Fehler! Verwenden Sie die Registerkarte 'Start', um dem Text zuzuweisen, der hier angezeigt werden soll.

Inbound message type	Response message type	Rule source	Validation rule ID	Validation rule description	Error code	Error description	Xpaths of inbound message elements for validation	Xpath of response message code element	Source rule name
							tTrf/UlmtDbtr/Id/OrigId/AnyBIC FICdtTrf/CdtTrfTxlnf/UndrlygCstmrCdtTrf/CdtrAgt/FinInstnId/BICFI FICdtTrf/CdtTrfTxlnf/UndrlygCstmrCdtTrf/IntrmyAgt3/FinInstnId/BICFI FICdtTrf/CdtTrfTxlnf/UndrlygCstmrCdtTrf/IntrmyAgt2/FinInstnId/BICFI FICdtTrf/CdtTrfTxlnf/UndrlygCstmrCdtTrf/IntrmyAgt1/FinInstnId/BICFI FICdtTrf/CdtTrfTxlnf/UndrlygCstmrCdtTrf/IntrmyAgt1/FinInstnId/BICFI		

Fehler! Verwenden Sie die Registerkarte 'Start', um Index of validation rules and error codes dem Text zuzuweisen. der hier

Inbound message type	Response message type	Rule source	Validation rule ID	Validation rule description	Error code	Error description	Xpaths of inbound message elements for validation	Xpath of response message code element	Source rule name
							nf/UndrlygCstmrCd tTrf/PrvsInstgAgt3/ FinInstnId/BICFI FICdtTrf/CdtTrfTxl nf/UndrlygCstmrCd tTrf/PrvsInstgAgt2/ FinInstnId/BICFI FICdtTrf/CdtTrfTxl nf/UndrlygCstmrCd tTrf/PrvsInstgAgt1/ FinInstnId/BICFI FICdtTrf/CdtTrfTxl nf/UndrlygCstmrCd tTrf/DbtrAgt/FinInst nId/BICFI FICdtTrf/CdtTrfTxl nf/Cdtr/FinInstnId/ BICFI FICdtTrf/CdtTrfTxl		

Fehler! Verwenden Sie die Registerkarte 'Start', um dem Text zuzuweisen, der hier angezeigt werden soll.

Inbound message type	Response message type	Rule source	Validation rule ID	Validation rule description	Error code	Error description	Xpaths of inbound message elements for validation	Xpath of response message code element	Source rule name
							nf/CdtrAgt/FinInstnId/BICFI FICdtTrf/CdtTrfTxlnf/DbtrAgt/FinInstnId/BICFI FICdtTrf/CdtTrfTxlnf/Dbtr/FinInstnId/BICFI FICdtTrf/CdtTrfTxlnf/IntrmyAgt3/FinInstnId/BICFI FICdtTrf/CdtTrfTxlnf/IntrmyAgt2/FinInstnId/BICFI FICdtTrf/CdtTrfTxlnf/IntrmyAgt1/FinInstnId/BICFI FICdtTrf/CdtTrfTxlnf/InstdAgt/FinInst		

Fehler! Verwenden Sie die Registerkarte 'Start', um Index of validation rules and error codes dem Text zuzuweisen. der hier

Inbound message type	Response message type	Rule source	Validation rule ID	Validation rule description	Error code	Error description	Xpaths of inbound message elements for validation	Xpath of response message code element	Source rule name
							nId/BICFI FICdtTrf/CdtTrfTxlnf/InstgAgt/FinInstnId/BICFI FICdtTrf/CdtTrfTxlnf/PrvsInstgAgt3/FinInstnId/BICFI FICdtTrf/CdtTrfTxlnf/PrvsInstgAgt2/FinInstnId/BICFI FICdtTrf/CdtTrfTxlnf/PrvsInstgAgt1/FinInstnId/BICFI		
pacs.010	pacs.002	T2	VR00070	'Instructing Agent' and 'Instructed Agent' must be known cash accounts in the addressed settlement service for the indicated currency.	E007	Account number / Account BIC in indicated currency unknown in addressed settlement service	FIDrctDbt/CdtInstr/InstgAgt/FinInstnId/BICFI FIDrctDbt/CdtInstr/InstdAgt/FinInstnId/BICFI	FIToFIPmtStsRpt/TxInfAndSts/StsRs nInf/Rsn/Prtry	

Fehler! Verwenden Sie die Registerkarte 'Start', um dem Text zuzuweisen, der hier angezeigt werden soll.

Inbound message type	Response message type	Rule source	Validation rule ID	Validation rule description	Error code	Error description	Xpaths of inbound message elements for validation	Xpath of response message code element	Source rule name
							FIDrctDbt/CdtInstr/DrctDbtTxInf/IntrBkSttlmAmt/Ccy		
pacs.010	pacs.002	T2	VR00100	<p>The business sender 'From' in the BAH must specify:</p> <p>For RTGS:</p> <ul style="list-style-type: none"> - for payment orders sent by the party itself: An Addressee BIC of the account given in 'Instructing Agent' element in the payload; - for payment orders sent by the CB acting on behalf: Party BIC of responsible CB of owner of account given in 	E010	Invalid business sender	<p>AppHdr/Fr/FlId/FinInstnId/BICFI</p> <p>FIDrctDbt/CdtInstr/InstgAgt/FinInstnId/BICFI</p> <p>FIDrctDbt/CdtInstr/DrctDbtTxInf/IntrBkSttlmAmt/Ccy</p>	<p>FIToFIPmtStsRpt/TxInfAndSts/StsRsnInf/Rsn/Prtry</p>	

Fehler! Verwenden Sie die Registerkarte 'Start', um Index of validation rules and error codesHeadinq2Reference dem Text zuzuweisen. der hier

Inbound message type	Response message type	Rule source	Validation rule ID	Validation rule description	Error code	Error description	Xpaths of inbound message elements for validation	Xpath of response message code element	Source rule name
				<p>'Instructing Agent' element in the payload.</p> <p>For CLM:</p> <ul style="list-style-type: none"> - for payment orders without code 'BLKD' in 'Local Instrument/Proprietary': Party BIC of owner of account given in 'Instructing Agent' element in the payload. - for payment orders with code 'BLKD' in 'Local Instrument/Proprietary': Party BIC of sending CB. 					
pacs.010	pacs.002	T2	VR00101	The business sender must be a CB.	E028	Business sender must be a CB	AppHdr/Fr/FIId/FinInstnId/BICFI	FiToFiPmtStsRpt/TxInfAndSts/StsRsnInf/Rsn/Prtry	

Fehler! Verwenden Sie die Registerkarte 'Start', um dem Text zuzuweisen, der hier angezeigt werden soll.

Inbound message type	Response message type	Rule source	Validation rule ID	Validation rule description	Error code	Error description	Xpaths of inbound message elements for validation	Xpath of response message code element	Source rule name
pac.010	pac.002	T2	VR00120	<p>The business receiver 'To' in the BAH must specify:</p> <p>For RTGS: An Addressee BIC of the account given in 'Instructed Agent' element in the payload.</p> <p>For CLM: The CLM system BIC.</p>	E012	Invalid business receiver	<p>AppHdr/To/FlId/FinInstnId/BICFI + For RTGS: FIDrctDbt/CdtInstr/InstdAgt/FinInstnId/BICFI FIDrctDbt/CdtInstr/DrctDbtTxInf/IntrBkSttlmAmt/Ccy</p>	FIToFIPmtStsRpt/TxInfAndSts/StsRsnInf/Rsn/Prtry	
pac.010	pac.002	T2	VR00150	<p>A payment order with the following identical field content in the defined timeframe is a duplicate:</p> <ul style="list-style-type: none"> - instructing agent; - message type; - instructed agent; - UETR; 	E015	Duplicate message payload	<p>FIDrctDbt/CdtInstr/InstgAgt/FinInstnId/BICFI AppHdr/MsgDefldr FIDrctDbt/CdtInstr/InstdAgt/FinInstnId/BICFI FIToFICstmrCdtTrf</p>	FIToFIPmtStsRpt/TxInfAndSts/StsRsnInf/Rsn/Prtry	

Fehler! Verwenden Sie die Registerkarte 'Start', um Index of validation rules and error codesHeadinq2Reference dem Text zuzuweisen. der hier

Inbound message type	Response message type	Rule source	Validation rule ID	Validation rule description	Error code	Error description	Xpaths of inbound message elements for validation	Xpath of response message code element	Source rule name
				- end to end identification; - settlement date; - settlement amount.			/CdtTrfTxInf/PmtId/UETR FIDrctDbt/CdtInstr/DrctDbtTxInf/PmtId/EndToEndId FIDrctDbt/CdtInstr/DrctDbtTxInf/IntrBkSttlmDt FIDrctDbt/CdtInstr/DrctDbtTxInf/IntrBkSttlmAmt		
pacs.010	pacs.002	T2	VR00170	For RTGS: A settlement date in the past is only allowed when the value date check is disabled for the instructing RTGS Account Holder. For CLM:	E016	Past settlement date not allowed	FIDrctDbt/CdtInstr/DrctDbtTxInf/IntrBkSttlmDt FIDrctDbt/CdtInstr/InstgAgt/FinInstnId/BICFI FIDrctDbt/CdtInstr/DrctDbtTxInf/IntrBk	FIToFIPmtStsRpt/TxInfAndSts/StsRsnInf/Rsn/Prtry	

Fehler! Verwenden Sie die Registerkarte 'Start', um dem Text zuzuweisen, der hier angezeigt werden soll.

Inbound message type	Response message type	Rule source	Validation rule ID	Validation rule description	Error code	Error description	Xpaths of inbound message elements for validation	Xpath of response message code element	Source rule name
				A settlement date in the past is not allowed.			SttlmAmt/Ccy		
pacs.010	pacs.002	T2	VR00180	Warehoused payments can be sent for a business day for the specified currency up to the defined number of calendar days in the future.	E017	Settlement date greater than latest submission date for warehoused payments or not a valid business day	FIDrctDbt/CdtInstr/DrctDbtTxInf/IntrBkSttlmDt FIDrctDbt/CdtInstr/DrctDbtTxInf/IntrBkSttlmAmt/Ccy	FIToFIPmtStsRpt/TxInfAndSts/StsRsnInf/Rsn/Prtry	
pacs.010	pacs.002	T2	VR00210	From time, till time and reject time must be within the relevant settlement window in this currency For CLM: Settlement window for CBOs. For RTGS: pacs.008: Settlement	E019	From time, till time or reject time outside of settlement window	FIDrctDbt/CdtInstr/DrctDbtTxInf/SttlmTmReq/FrTm FIDrctDbt/CdtInstr/DrctDbtTxInf/SttlmTmReq/TillTm FIDrctDbt/CdtInstr/DrctDbtTxInf/SttlmTmReq/RjctTm FIDrctDbt/CdtInstr/	FIToFIPmtStsRpt/TxInfAndSts/StsRsnInf/Rsn/Prtry	

Fehler! Verwenden Sie die Registerkarte 'Start', um Index of validation rules and error codesHeadinq2Reference dem Text zuzuweisen. der hier

Inbound message type	Response message type	Rule source	Validation rule ID	Validation rule description	Error code	Error description	Xpaths of inbound message elements for validation	Xpath of response message code element	Source rule name
				window for customer payments pacs.009 and pacs.010: Settlement window for interbank payments.			DrctDbtTxInf/IntrBkSttlmAmt/Ccy		
pacs.010	pacs.002	T2	VR00230	From time must be before latest debit time (reject time or till time).	E021	From time after latest debit time (reject time or till time)	FIDrctDbt/CdtInstr/DrctDbtTxInf/SttlmTmReq/FrTm FIDrctDbt/CdtInstr/DrctDbtTxInf/SttlmTmReq/TillTm FIDrctDbt/CdtInstr/DrctDbtTxInf/SttlmTmReq/RjctTm	FIToFIPmtStsRpt/TxInfAndSts/StsRsnInf/Rsn/Prtry	
pacs.010	pacs.002	T2	VR00231	All timeshifts for from time and latest debit time (reject time or till time) must be identical.	E093	Invalid timeshifts	FIDrctDbt/CdtInstr/DrctDbtTxInf/SttlmTmReq/FrTm FIDrctDbt/CdtInstr/DrctDbtTxInf/SttlmTmReq/TillTm	FIToFIPmtStsRpt/TxInfAndSts/StsRsnInf/Rsn/Prtry	

Fehler! Verwenden Sie die Registerkarte 'Start', um dem Text zuzuweisen, der hier angezeigt werden soll.

Inbound message type	Response message type	Rule source	Validation rule ID	Validation rule description	Error code	Error description	Xpaths of inbound message elements for validation	Xpath of response message code element	Source rule name
							FIDrctDbt/CdtInstr/DrctDbtTxInf/StlmTmReq/RjctTm		
pacs.010	pacs.002	T2	VR00240	For payment orders with settlement date equal to the current business day or in the past, the till time and reject time must be after the current system time.	E022	Till time or reject time earlier than current system time	FIDrctDbt/CdtInstr/DrctDbtTxInf/StlmTmReq/TillTm FIDrctDbt/CdtInstr/DrctDbtTxInf/StlmTmReq/RjctTm	FIToFIPmtStsRpt/TxInfAndSts/StsRsnInf/Rsn/Prtry	
pacs.010	pacs.002	T2	VR00251	The payment order is rejected due to reach of reject time.	E076	Reject time reached		FIToFIPmtStsRpt/TxInfAndSts/StsRsnInf/Rsn/Prtry	
pacs.010	pacs.002	T2	VR00252	At least one of the impacted parties or accounts is blocked. The earmarked cash transfer order has been disagreed by the	E023	Central bank disagreed to earmarked cash transfer order		FIToFIPmtStsRpt/TxInfAndSts/StsRsnInf/Rsn/Prtry	

Fehler! Verwenden Sie die Registerkarte 'Start', um Index of validation rules and error codesHeadinq2Reference dem Text zuzuweisen. der hier

Inbound message type	Response message type	Rule source	Validation rule ID	Validation rule description	Error code	Error description	Xpaths of inbound message elements for validation	Xpath of response message code element	Source rule name
				respective CB/OT.					
pacs.010	pacs.002	T2	VR00271	<p>For RTGS: The instructing agent must be a valid RTGS DCA, RTGS CB account or AS guarantee funds account.</p> <p>For CLM: The instructing agent must be a valid CLM CB account or in case of a direct debit with code "BLKD" the instructing agent can also be a valid MCA account.</p>	E013	Invalid account type for InstructingAgent (pacs) or DebtorAccount (camt)	FIDrctDbt/CdtInstr/InstgAgt/FinInstnId/BICFI	FIToFIPmtStsRpt/TxInfAndSts/StsRsnInf/Rsn/Prtry	
pacs.010	pacs.002	T2	VR00280	The instructing agent and	E096	InstructingAgent and	FIDrctDbt/CdtInstr/	FIToFIPmtStsRpt/	

Fehler! Verwenden Sie die Registerkarte 'Start', um dem Text zuzuweisen, der hier angezeigt werden soll.

Inbound message type	Response message type	Rule source	Validation rule ID	Validation rule description	Error code	Error description	Xpaths of inbound message elements for validation	Xpath of response message code element	Source rule name
				the instructed agent must be different.		InstructedAgent must be different	InstdAgt/FinInstnId /BICFI FIDrctDbt/CdtInstr/InstgAgt/FinInstnId /BICFI	TxInfAndSts/StsRsnInf/Rsn/Prtry	
pacs.010	pacs.002	T2	VR00290	For RTGS: The instructed agent must be a valid RTGS DCA, RTGS CB account or AS guarantee funds account, if code 'SBTI' is not used in Local Instrument/Code (relevant for pacs.009 only). For CLM: The instructed agent must be a valid MCA or	E014	Invalid account type for InstructedAgent (pacs) or CreditorAccount (camt)	FIDrctDbt/CdtInstr/InstdAgt/FinInstnId /BICFI	FIToFIPmtStsRpt/TxInfAndSts/StsRsnInf/Rsn/Prtry	

Fehler! Verwenden Sie die Registerkarte 'Start', um Index of validation rules and error codesHeadinq2Reference dem Text zuzuweisen. der hier

Inbound message type	Response message type	Rule source	Validation rule ID	Validation rule description	Error code	Error description	Xpaths of inbound message elements for validation	Xpath of response message code element	Source rule name
				CLM CB account.					
pacs.010	pacs.002	T2	VR00310	If code 'BLKD' (only relevant for pacs.010) or 'CONP' is used in Local Instrument/Proprietary, no reject time is allowed.	E025	Reject time not allowed for this cash transfer type	FIDrctDbt/CdtInstr/DrctDbtTxInf/PmtTpInf/LclInstrm/Prtry FIDrctDbt/CdtInstr/DrctDbtTxInf/SttlmTmReq/RjctTm	FIToFIPmtStsRpt/TxInfAndSts/StsRsnInf/Rsn/Prtry	
pacs.010	pacs.002	T2	VR00320	In case of a connected payment: - the instructed agent must be an MCA; - the instructing agent must be a CLM CB account; - both accounts must have the same responsible CB.	E026	Connected payment not allowed	FIDrctDbt/CdtInstr/DrctDbtTxInf/PmtTpInf/LclInstrm/Prtry FIDrctDbt/CdtInstr/InstAgt/FinInstnld/BICFI FIDrctDbt/CdtInstr/InstgAgt/FinInstnld/BICFI AppHdr/Fr/Flld/FinInstnld/BICFI	FIToFIPmtStsRpt/TxInfAndSts/StsRsnInf/Rsn/Prtry	
pacs.010	pacs.002	T2	VR00330	If code 'CONP' is used in	E027	Code 'CONP' not	FIDrctDbt/CdtInstr/	FIToFIPmtStsRpt/	

Fehler! Verwenden Sie die Registerkarte 'Start', um dem Text zuzuweisen, der hier angezeigt werden soll.

Inbound message type	Response message type	Rule source	Validation rule ID	Validation rule description	Error code	Error description	Xpaths of inbound message elements for validation	Xpath of response message code element	Source rule name
				Local Instrument/Proprietary, the code has to be followed by a '/' and a positive amount with maximum 18 numeric characters including mandatory decimal point and 0 to 2 decimal places.		followed by a valid amount	DrctDbtTxInf/PmtTpInf/LclInstrm/Prtry	TxInfAndSts/StsRsnInf/Rsn/Prtry	
pacs.010	pacs.002	T2	VR00580	For RTGS: The account holder of the instructing agent/payee must be authorised to debit the instructed agent/payer (direct debit mandate). For CLM:	E044	InstructingAgent not mandated to debit InstructedAgent	FIDrctDbt/CdtInstr/InstgAgt/FinInstnId/BICFI FIDrctDbt/CdtInstr/InstdAgt/FinInstnId/BICFI FIDrctDbt/CdtInstr/DrctDbtTxInf/IntrBkSttlmAmt/Ccy	FIToFIPmtStsRpt/TxInfAndSts/StsRsnInf/Rsn/Prtry	

Fehler! Verwenden Sie die Registerkarte 'Start', um Index of validation rules and error codesHeadinq2Reference dem Text zuzuweisen. der hier

Inbound message type	Response message type	Rule source	Validation rule ID	Validation rule description	Error code	Error description	Xpaths of inbound message elements for validation	Xpath of response message code element	Source rule name
				If the business sender is not the responsible CB of the instructed agent/payer, the account holder of the instructing agent/payee must be authorised to debit the instructed agent/payer (direct debit mandate).					
pac.s.010	pac.s.002	T2	VR00590	For RTGS: The amount of the direct debit payment order must be lower than or equal to the defined maximum amount for a single direct debit payment order from the instructed agent/payer towards the account holder of the instructing	E045	Direct debit amount exceeds the maximum amount per payment	FIDrctDbt/CdtInstr/ InstgAgt/FinInstnId /BICFI FIDrctDbt/CdtInstr/ InstdAgt/FinInstnId /BICFI FIDrctDbt/CdtInstr/ DrctDbtTxInf/IntrBk SttlmAmt FIDrctDbt/CdtInstr/	FIToFIPmtStsRpt/ TxInfAndSts/StsRs nInf/Rsn/Prtry	

Fehler! Verwenden Sie die Registerkarte 'Start', um dem Text zuzuweisen, der hier angezeigt werden soll.

Inbound message type	Response message type	Rule source	Validation rule ID	Validation rule description	Error code	Error description	Xpaths of inbound message elements for validation	Xpath of response message code element	Source rule name
				agent/payee. For CLM: If the account holder of the instructing agent/payee is not the responsible CB of the instructed agent/payer, the amount of the direct debit payment order must be lower than or equal to the defined maximum amount for a single direct debit payment order from the instructed agent/payer towards the account holder of the instructing agent/payee.			DrctDbtTxInf/IntrBkStlmAmt/Ccy		
pacs.010	pacs.002	T2	VR00605	Code 'BLKD' in Local	E077	Code 'BLKD' only	FIDrctDbt/CdtInstr/	FIToFIPmtStsRpt/	

Fehler! Verwenden Sie die Registerkarte 'Start', um Index of validation rules and error codesHeadinq2Reference dem Text zuzuweisen. der hier

Inbound message type	Response message type	Rule source	Validation rule ID	Validation rule description	Error code	Error description	Xpaths of inbound message elements for validation	Xpath of response message code element	Source rule name
				Instrument/Proprietary is only allowed, if business sender is the responsible CB of 'Instructed Agent'.		allowed by responsible CB	DrctDbtTxInf/PmtTpInf/LclInstrm/Prtry	TxInfAndSts/StsRsnInf/Rsn/Prtry	
pacs.010	pacs.002	T2	VR00610	For RTGS: The sum of the amount of the direct debit to be settled and the total amount of already settled direct debits of the account holder of the instructing agent/payee must be lower than or equal to the defined maximum amount for direct debits per day from the instructed agent/payer towards the account holder of the instructing agent/payee.	E046	Sum of direct debits exceeds the maximum daily amount for account holder of InstructingAgent	FIDrctDbt/CdtInstr/InstgAgt/FinInstnId/BICFI FIDrctDbt/CdtInstr/InstdAgt/FinInstnId/BICFI FIDrctDbt/CdtInstr/DrctDbtTxInf/IntrBkSttlmAmt FIDrctDbt/CdtInstr/DrctDbtTxInf/IntrBkSttlmAmt/Ccy	FIToFIPmtStsRpt/TxInfAndSts/StsRsnInf/Rsn/Prtry	

Fehler! Verwenden Sie die Registerkarte 'Start', um dem Text zuzuweisen, der hier angezeigt werden soll.

Inbound message type	Response message type	Rule source	Validation rule ID	Validation rule description	Error code	Error description	Xpaths of inbound message elements for validation	Xpath of response message code element	Source rule name
				<p>For CLM: If the account holder of the instructing agent/payee is not the responsible CB of the instructed agent/payer, the sum of the amount of the direct debit to be settled and the total amount of already settled direct debits of the account holder of the instructing agent/payee must be lower than or equal to the defined maximum amount for direct debits per day from the instructed agent/payer towards the</p>					

Fehler! Verwenden Sie die Registerkarte 'Start', um Index of validation rules and error codesHeadinq2Reference dem Text zuzuweisen. der hier

Inbound message type	Response message type	Rule source	Validation rule ID	Validation rule description	Error code	Error description	Xpaths of inbound message elements for validation	Xpath of response message code element	Source rule name
				account holder of the instructing agent/payee.					
pac.010	pac.002	T2	VR00620	<p>For RTGS: The sum of the amounts of the direct debit to be settled and the total amount of already settled direct debits for the instructed agent/payer must be lower than or equal to the defined maximum amount for direct debits per day for the instructed agent/payer.</p> <p>For CLM: If the account holder of the instructing agent/payee is not the</p>	E047	Sum of direct debits exceeds the maximum daily amount for InstructedAgent	<p>FIDrctDbt/CdtInstr/InstdAgt/FinInstnId/BICFI</p> <p>FIDrctDbt/CdtInstr/DrctDbtTxInf/IntrBkStlmAmt</p> <p>FIDrctDbt/CdtInstr/DrctDbtTxInf/IntrBkStlmAmt/Ccy</p>	FIToFIPmtStsRpt/TxInfAndSts/StsRsnInf/Rsn/Prtry	

Fehler! Verwenden Sie die Registerkarte 'Start', um dem Text zuzuweisen, der hier angezeigt werden soll.

Inbound message type	Response message type	Rule source	Validation rule ID	Validation rule description	Error code	Error description	Xpaths of inbound message elements for validation	Xpath of response message code element	Source rule name
				responsible CB of the instructed agent/payer, the sum of the amounts of the direct debit to be settled and the total amount of already settled direct debits for the instructed agent/payer must be lower than or equal to the defined maximum amount for direct debits per day for the instructed agent/payer.					
pac.010	pac.002	T2	VR00840	The cash transfer order has been revoked.	E067	Cash transfer order revoked		FIToFIPmtStsRpt/TxInfAndSts/StsRsnInf/Rsn/Prtry	
pac.010	pac.002	T2	VR01110	For a connected payment decreasing the liquidity, no delta credit	E101	Connected payment not accepted due to pending delta credit line		FIToFIPmtStsRpt/TxInfAndSts/StsRsnInf/Rsn/Prtry	

Fehler! Verwenden Sie die Registerkarte 'Start', um Index of validation rules and error codesHeadinq2Reference dem Text zuzuweisen. der hier

Inbound message type	Response message type	Rule source	Validation rule ID	Validation rule description	Error code	Error description	Xpaths of inbound message elements for validation	Xpath of response message code element	Source rule name
				line modifications must be pending for the same MCA.		modifications			
pacs.010	pacs.002	T2	VR01120	For a connected payment decreasing the liquidity, the MCA must have sufficient liquidity. For a connected payment debiting the CB account, the CB account must be not credit-based only or must have sufficient liquidity.	E042	Insufficient liquidity		FIToFIPmtStsRpt/TxInfAndSts/StsRsnInf/Rsn/Prtry	
pacs.010	pacs.002	T2	VR01140	For a seizure of funds payment (code 'BLKD'), the payment amount must not exceed the current seizure of funds reservation.	E042	Insufficient liquidity		FIToFIPmtStsRpt/TxInfAndSts/StsRsnInf/Rsn/Prtry	

Fehler! Verwenden Sie die Registerkarte 'Start', um dem Text zuzuweisen, der hier angezeigt werden soll.

Inbound message type	Response message type	Rule source	Validation rule ID	Validation rule description	Error code	Error description	Xpaths of inbound message elements for validation	Xpath of response message code element	Source rule name
pacs.010	pacs.002	T2	VR01240	A connected payment or a credit line modification with currency 'EUR' is not allowed by a CB after ECMS go-live.	E099	Instruction not allowed after ECMS go-live	FIDrctDbt/CdtInstr/DrctDbtTxInf/PmtTpInf/LclInstrm/Prtry FIDrctDbt/CdtInstr/DrctDbtTxInf/IntrBkSttlmAmt/Ccy	FIToFIPmtStsRpt/TxInfAndSts/StsRsnInf/Rsn/Prtry	

Fehler! Verwenden Sie die Registerkarte 'Start', um Index of validation rules and error codesHeadinq2Reference dem Text zuzuweisen. der hier

Inbound message type	Response message type	Rule source	Validation rule ID	Validation rule description	Error code	Error description	Xpaths of inbound message elements for validation	Xpath of response message code element	Source rule name
pac.s.010	pac.s.002	ISO	IV00290	The currency code must be a valid active currency code, not yet withdrawn on the day the message containing the currency is exchanged. Valid active currency codes are registered with the ISO 4217 Maintenance Agency, consist of three (3) contiguous letters, and are not yet withdrawn on the day the message containing the Currency is exchanged.	D005	Invalid active currency code in //Dynamic error including xpath//	FIDrctDbt/CdtInstr/DrctDbtTxInf/IntrBkSttlmAmt/Ccy FIDrctDbt/CdtInstr/DrctDbtTxInf/DbtrAgtAcct/Ccy FIDrctDbt/CdtInstr/DrctDbtTxInf/DbtrAcct/Ccy FIDrctDbt/CdtInstr/CdtrAcct/Ccy FIDrctDbt/CdtInstr/CdtrAgtAcct/Ccy	FIToFIPmtStsRpt/TxInfAndSts/StsRsnInf/Rsn/Prtry	ActiveCurrency
pac.s.010	pac.s.002	ISO	IV00310	The number of fractional digits (or minor unit of currency) must comply with ISO 4217. Note: The decimal	D007	Invalid decimal digits for the specified currency in //Dynamic error including xpath//	FIDrctDbt/CdtInstr/DrctDbtTxInf/IntrBkSttlmAmt/Ccy FIDrctDbt/CdtInstr/	FIToFIPmtStsRpt/TxInfAndSts/StsRsnInf/Rsn/Prtry	CurrencyAmount

Fehler! Verwenden Sie die Registerkarte 'Start', um dem Text zuzuweisen, der hier angezeigt werden soll.

Inbound message type	Response message type	Rule source	Validation rule ID	Validation rule description	Error code	Error description	Xpaths of inbound message elements for validation	Xpath of response message code element	Source rule name
				separator is a dot.			DrctDbtTxInf/IntrBkStlmAmt		
pacs.010	pacs.002	ISO	IV00320	Only a valid Business identifier code is allowed. Business identifier codes for financial or nonfinancial institutions are registered and published by the ISO 9362 Registration Authority in the ISO directory of BICs, and consists of eleven (11) contiguous characters.	D008	Invalid financial or non-financial institution BIC in //Dynamic error including xpath//	FIDrctDbt/CdtInstr/ DrctDbtTxInf/DbtrA gt/FinInstnId/BICFI FIDrctDbt/CdtInstr/ DrctDbtTxInf/Dbtr/ FinInstnId/BICFI FIDrctDbt/CdtInstr/ Cdtr/FinInstnId/BIC FI FIDrctDbt/CdtInstr/ CdtrAgt/FinInstnId/ BICFI FIDrctDbt/CdtInstr/ InstAgt/FinInstnId /BICFI FIDrctDbt/CdtInstr/ InstgAgt/FinInstnId /BICFI	FIToFIPmtStsRpt/ TxInfAndSts/StsRs nInf/Rsn/Prtry	AnyBIC

Table 258 - CLM business rules

14.2 Digital signature on business layer

14.2.1 Mechanism and introduction for signature constructions

This annex outlines how signatures are constructed for the business messages. The following business message types have been identified:

- I message type 1: file with multiple ISO 20022 messages;
- I message type 2: single ISO 20022 BAH and message.

The design goal for the proposed construction of signatures in the following chapters is that as much as possible is handled by standard XML digital signature processing specifications and as little as possible by specific processing. This makes it less likely that errors and/or discrepancies occur in the different implementations, and therefore improve the overall security of the solution.

14.2.2 Use of XML and canonicalisation algorithm

Exclusive XML canonicalization⁹² has to be performed for above-mentioned business messages on extracted data. It is important to ensure a context free extraction otherwise the signatures will be broken if either the message or the signature itself was modified due to inherited namespaces.

This implies that the canonicalization algorithm specified in the “SignedInfo” element and in all the references should be in line with following information:

<http://www.w3.org/2001/10/xml-exc-c14n#>

14.2.3 Message type 1: file with multiple ISO 20022 messages

For message type 1) the requirement in the ESMIG UDFS chapter “*Digital Signature managed within the business Layer*” states:

“The Non Repudiation of Origin (NRO)⁹³ signature is stored in the BAH in case of individual messages or in the file header in case of messages grouped into a file. In case messages are grouped into a file, the BAH of the individual messages will not include a signature.

File (meaning multi-message):

⁹² Exclusive XML canonicalisation <http://www.w3.org/TR/xml-exc-c14n/>

⁹³ Non-repudiation of origin is intended to protect against the originator's false denial of having sent the message.

The signature is part of the file header. It is over the list of BAH's and ISO 20022 messages and covers the whole <XChg> element of the BFH (head.002), except for the signature itself." Consequently, the BAH of each single message within the file will not have its own signature.

The signature, in particular, covers the whole "BusinessFileHeader <XChg>" element, except for the signature itself. So consequently the following field is not taken into account for signature calculation:

Xchg/PyldDesc/AppIspfcInf/Sgntr/ds:Signature⁹⁴

Hence a signature is then constructed as follows.

- I One reference (in blue below) points out the XChg itself. This is done using the same document reference URI = "", which means the entire document. To leave the signature element itself out of the digest calculation, the transform "#enveloped-signature" is used.
- I One reference (in yellow below) points to the keyinfo element of the signature itself. This is a XAdES⁹⁵ requirement.

1) A message type 1⁹⁶ signature example is reported in the below picture:

```
<ds:Signature Id="_8aaee938-014d-489e-a385-b72155000474" xmlns:ds="http://www.w3.org/2000/09/xmldsig#">
  <ds:SignedInfo>
    <ds:CanonicalizationMethod Algorithm="http://www.w3.org/2001/10/xml-exc-c14n#" />
    <ds:SignatureMethod Algorithm="http://www.w3.org/2001/04/xmldsig-more#rsa-sha256" />
    <ds:Reference URI="">
      <ds:Transforms>
        <ds:Transform Algorithm="http://www.w3.org/2000/09/xmldsig#enveloped-signature" />
        <ds:Transform Algorithm="http://www.w3.org/2001/10/xml-exc-c14n#" />
      </ds:Transforms>
      <ds:DigestMethod Algorithm="http://www.w3.org/2001/04/xmlenc#sha256" />
      <ds:DigestValue>GUTJy22YxtDXe7yEvdYfJ/GYM+pGH4h5dgWe7c+2gXU=</ds:DigestValue>
    </ds:Reference>
    <ds:Reference URI="#_4eaf74f7-086b-410e-b214-45136a615bac">
      <ds:Transforms>
        <ds:Transform Algorithm="http://www.w3.org/2001/10/xml-exc-c14n#" />
      </ds:Transforms>
      <ds:DigestMethod Algorithm="http://www.w3.org/2001/04/xmlenc#sha256" />
      <ds:DigestValue>8GepFq00h78WgVHh23B16RFQRWhdfM6AjY+b0texoSk=</ds:DigestValue>
    </ds:Reference>
  </ds:SignedInfo>
  <ds:SignatureValue>QzvbmDLi8Q1PnsfKz...HNgew=</ds:SignatureValue>
  <ds:KeyInfo Id="_4eaf74f7-086b-410e-b214-45136a615bac">
    <ds:X509Data>
      <ds:X509Certificate>MIIEXTCCA8ag...IY5uXk03IGZ3XUsw=</ds:X509Certificate>
    </ds:X509Data>
  </ds:KeyInfo>
</ds:Signature>
```

Reference to the whole document, less the signature

Reference to KeyInfo (a XAdES Requirement)

Figure 94 - Message type 1, signature

Reference to the message (head.002):

94 Due to the XAdES requirement the ds:keyinfo element inside the ds:signature is covered/protected by the signature.

95 ETSI TS 101 903 V1.4.2 (2010-12) XML advanced electronic signatures

96 ESMIG digital signature services are configured to produce and generate rsa-sha256 signatures, and use sha256 digest.

```

<Pyld>
<BizData xmlns="urn:iso:std:iso:20022:tech:xsd:head.003.001.01">
  <AppHdr xmlns="urn:iso:std:iso:20022:tech:xsd:head.001.001.01">
    <Fr>
      <FIId>
        <FinInstnId>
          <BICFI>COBAEFFXXX</BICFI>
          <ClrSysMmbId>
            <MmbId>BizSenderb010UserId</MmbId>
          </ClrSysMmbId>
        </FinInstnId>
      </FIId>
    </Fr>
    <To>
      <FIId>
        <FinInstnId>
          <BICFI>TRGTXPMLM</BICFI>
        </FinInstnId>
      </FIId>
    </To>
    <BizMsgId>Inc050b010-BAHId</BizMsgId>
    <MsgDefId>camt.050.001.05</MsgDefId>
    <CreDt>2019-10-07T13:05:00Z</CreDt>
  </AppHdr>

  <Document xmlns="urn:iso:std:iso:20022:tech:xsd:camt.050.001.05">
    <LqdtCdtTrf>
      <MsgHdr>
        <MsgId>NONREF</MsgId>
      </MsgHdr>
      <LqdtCdtTrf>
        <LqdtTrfId>
          <EndToEndId>Inc050b050-E2EId</EndToEndId>
        </LqdtTrfId>
        <CdtrAcct>
          <Id>
            <Othr>
              <Id>MDEEURSOLADESTXXXSOLADESTXXX</Id>
            </Othr>
          </Id>
        </CdtrAcct>
        <TrfdAmt>
          <AmtwthCcy Ccy="EUR">100000.00</AmtwthCcy>
        </TrfdAmt>
        <DbtrAcct>
          <Id>
            <Othr>
              <Id>MDEEURCOBAEFFXXXCOBAEFFXXX</Id>
            </Othr>
          </Id>
        </DbtrAcct>
      </LqdtCdtTrf>
    </LqdtCdtTrf>
  </Document>
</BizData>
</Pyld>
</Xchg>

```

Figure 96 - Message type 1, complete example

14.2.4 Message type 2: single ISO 20022 message

For message type 2) the requirement in ESMIG UDFS chapter “*Digital Signature managed within the business layer*” states:⁹⁷

”Single message: The signature is over the ISO 20022 message and takes into account the business processing relevant information specified within the BAH (e.g. pair of BICs for definition of the instructing party), except for the signature itself. The digital signature grouped in the BAH itself is not part of this signature calculation.”

So consequently the following field is not taken into account for signature calculation:

AppHdr/Sgntr/ds:Signature⁹⁸

97 See also MUG (message user guide) for BAH; <http://www.iso20022.org/bah.page>

In this case the BAH and the ISO 20022 message are considered not to be in the same document.

"Technically speaking, the Application Header is a separate XML document standing apart from the XML documents which represent the business message instance itself."

Since the documents that are referenced do not carry an ID attribute⁹⁹ that could be used for identifying the specific document, it has been decided to use a specific reference for the business message, ESMIG ensures that the BAH and the corresponding ISO message are always stored together.

TARGET Service specific reference for document signature

In the XML digital signature standard there is the possibility to use a reference with no URI i.e. omitting the URI attribute entirely. However there can be at most one such reference in a signature, and handling of it is specific, and not covered by the XML digital signature standard.¹⁰⁰ Hence the reference to the message must be given by the context and known by the application.

The signature is then constructed as follows.

- I One reference (in blue below) points out the BAH (AppHdr) itself. This is done using the same document reference URI = "", which means the entire document. To leave the signature element itself out of the digest calculation, the transform "#enveloped-signature" is used.
- I One reference (in green below) is application specific and refers to the business message (no URI). The application provides the signature Application Programming Interface (API) with the relevant message. The signature API is customised to resolve the no URI reference to this message.
- I One reference (in yellow below) points to the keyinfo element of the signature itself (XAdes requirements).

1) A message type 2¹⁰¹ signature example (with application specific reference) is reported in the below picture:

98 Due to the XAdES requirement the ds:keyinfo element inside the ds:signature is covered/protected by the signature.

99 ISO 20022 do not support and specify an ID attribute, that can be used to uniquely identify BAH and ISO message.

100 XML signature syntax and processing (Second Edition), W3C Recommendation 10 June 2008, "<http://www.w3.org/TR/xmlsig-core/>"

101 ESMIG digital signature services are configured to produce and generate rsa-sha256 signatures, and use sha256 digest.

```
<ds:Signature Id="_003adca5-654a-473d-b1cf-3e826cd5d3f7" xmlns:ds="http://www.w3.org/2000/09/xmldsig#">
  <ds:SignedInfo>
    <ds:CanonicalizationMethod Algorithm="http://www.w3.org/2001/10/xml-exc-c14n#" />
    <ds:SignatureMethod Algorithm="http://www.w3.org/2001/04/xmldsig-more#rsa-sha256" />
    <ds:Reference URI="">
      <ds:Transforms>
        <ds:Transform Algorithm="http://www.w3.org/2000/09/xmldsig#enveloped-signature" />
        <ds:Transform Algorithm="http://www.w3.org/2001/10/xml-exc-c14n#" />
      </ds:Transforms>
      <ds:DigestMethod Algorithm="http://www.w3.org/2001/04/xmenc#sha256" />
      <ds:DigestValue>Ffg8hActTHIR9tyj8BOP2/7FMMyECb9wb7CKQvhG5z/A=</ds:DigestValue>
    </ds:Reference>
    <ds:Reference>
      <ds:Transforms>
        <ds:Transform Algorithm="http://www.w3.org/2001/10/xml-exc-c14n#" />
      </ds:Transforms>
      <ds:DigestMethod Algorithm="http://www.w3.org/2001/04/xmenc#sha256" />
      <ds:DigestValue>hEXN3t4XgQt2fkJf7WH4xgg/21cKPaAUnfDII7vIdoQ=</ds:DigestValue>
    </ds:Reference>
    <ds:Reference URI="#_4eaf74f7-086b-410e-b214-45136a615bac">
      <ds:Transforms>
        <ds:Transform Algorithm="http://www.w3.org/2001/10/xml-exc-c14n#" />
      </ds:Transforms>
      <ds:DigestMethod Algorithm="http://www.w3.org/2001/04/xmenc#sha256" />
      <ds:DigestValue>bcF4Ty77sjsGLXSd5YbSQqJijbwy4RRBJxh8zPEFbco=</ds:DigestValue>
    </ds:Reference>
  </ds:SignedInfo>
  <ds:SignatureValue>Ft1F0n3hzk5Y78Tm/...newuw=</ds:SignatureValue>
  <ds:KeyInfo Id="_05dda060-fd01-4538-9db0-56c8e5d3dfc1">
    <ds:X509Data>
      <ds:X509Certificate>MIIEXTCCA8ag...IY5uXk03IGZ3XUsw=</ds:X509Certificate>
    </ds:X509Data>
  </ds:KeyInfo>
</ds:Signature>
```

Figure 97 - Message type 2, signature

General remark: The signature is over the ISO 20022 message and takes into account the business processing relevant information specified within the message header (BAH), except the signature itself. The digital signature in the BAH itself is NOT part of this signature calculation.

Reference to the BAH (AppHdr):

```
<AppHdr xmlns="urn:iso:std:iso:20022:tech:xsd:head.001.001.01">
  <FR>
    <FIId>
      <FinInstnId>
        <BICFI>MARKDEFFXXX</BICFI>
        <ClrSysMmbId>
          <MmbId>BizSenderb008UserId</MmbId>
        </ClrSysMmbId>
      </FinInstnId>
    </FIId>
  </FR>
  <TO>
    <FIId>
      <FinInstnId>
        <BICFI>TRGTXEPHCLM</BICFI>
      </FinInstnId>
    </FIId>
  </TO>
  <BizMsgId>Inp009b008-BAHId</BizMsgId>
  <MsgDefId>pacs.009.001.08</MsgDefId>
  <CreDt>2019-10-07T10:00:00Z</CreDt>
  <Sgntr>...</Sgntr>
</AppHdr>
```

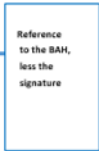

Figure 98 - Message type 2, reference to the BAH

Reference to the business message (camt.050):

```
<Document xmlns="urn:iso:std:iso:20022:tech:xsd:camt.050.001.05">
  <LqdtCdtTrf>
    <MsgHdr>
      <MsgId>NONREF</MsgId>
    </MsgHdr>
    <LqdtCdtTrf>
      <LqdtTrfId>
        <EndToEndId>Inc050b050-E2EId</EndToEndId>
      </LqdtTrfId>
      <CdtrAcct>
        <Id>
          <Othr>
            <Id>NDEEURSOLADESTXXXSOLADESTXXX</Id>
          </Othr>
        </Id>
      </CdtrAcct>
      <TrfdAmt>
        <AmtwthCcy Ccy="EUR">100000.00</AmtwthCcy>
      </TrfdAmt>
      <DbtrAcct>
        <Id>
          <Othr>
            <Id>NDEEURCOBADEFFXXXCOBADEFFXXX</Id>
          </Othr>
        </Id>
      </DbtrAcct>
    </LqdtCdtTrf>
  </LqdtCdtTrf>
</Document>
```

The application will provide the signature API with the relevant message

Figure 99 - Message type 2, Reference to the Message

2) A message type 2 structure example (including signature) is provided in XML format as described below:

```
<AppHdr xmlns="urn:iso:std:iso:20022:tech:xsd:head.001.001.01">
  <Fr>
    <FIId>
      <FinInstnId>
        <BICFI>MARKADEFXXX</BICFI>
        <ClrSysMmbId>
          <MmbId>BizSenderb008UserId</MmbId>
        </ClrSysMmbId>
      </FinInstnId>
    </FIId>
  </Fr>
  <To>
    <FIId>
      <FinInstnId>
        <BICFI>TRGTXEPHCLM</BICFI>
      </FinInstnId>
    </FIId>
  </To>
  <BizMsgId>Inp050b321-BAHId</BizMsgId>
  <MsgDefId>camt.050.001.05</MsgDefId>
  <CreDt>2019-10-07T10:00:00Z</CreDt>
</AppHdr>
<Sgntr>
  <ds:Signature Id="be4dd7de-c63a-43a6-9b62-f69290939eb6" xmlns:ds="http://www.w3.org/2000/09/xmldsig#">
    <ds:SignedInfo>
      <ds:CanonicalizationMethod Algorithm="http://www.w3.org/2001/10/xml-exc-c14n#">
      <ds:SignatureMethod Algorithm="http://www.w3.org/2001/04/xmldsig-more#rsa-sha256"/>
      <ds:Reference URI="#_98742d60-2afc-4fa7-a731-828756ce47b1">
        <ds:Transforms>
          <ds:Transform Algorithm="http://www.w3.org/2001/10/xml-exc-c14n#">
          </ds:Transforms>
        <ds:DigestMethod Algorithm="http://www.w3.org/2001/04/xmenc#sha256"/>
        <ds:DigestValue>vB/xxu+qkEVUHSi9uVdBHOXop6+XDSAn/iHXH+UIMGo=</ds:DigestValue>
      </ds:Reference>
      <ds:Reference URI="">
        <ds:Transforms>
          <ds:Transform Algorithm="http://www.w3.org/2000/09/xmldsig#enveloped-signature"/>
          <ds:Transform Algorithm="http://www.w3.org/2001/10/xml-exc-c14n#">
          </ds:Transforms>
        <ds:DigestMethod Algorithm="http://www.w3.org/2001/04/xmenc#sha256"/>
        <ds:DigestValue>hWGKHPu5IMYxe4KFYyaMOFwYq0w2pi+8YnYVHEwm/Z8=</ds:DigestValue>
      </ds:Reference>
      <ds:Reference>
        <ds:Transforms>
          <ds:Transform Algorithm="http://www.w3.org/2001/10/xml-exc-c14n#">
          </ds:Transforms>
        <ds:DigestMethod Algorithm="http://www.w3.org/2001/04/xmenc#sha256"/>
        <ds:DigestValue>10eHendJm1v177M0HzFsmP0I8MYvdPXUrcR77hagUg=</ds:DigestValue>
      </ds:Reference>
    </ds:SignedInfo>
    <ds:SignatureValue>HllityLicuusdrRrzu5CFk5GZ3LD00nEPCrXkfwiu54y0zA3P2r6Aie1cYIdueY8nioLEvcZcv54zt6bbHv8Rra
Wmu+3f13x4VH5g8W6RY10LPERbDTncn9r3Nd/hxeBj6Rztv3vR+gw+3Y2ly3pkTIAb80JhQ9kcauarcwG6MAW3UjK31j796Ld17ddvHohgwiqHXZ
didBfcOnatYnXZrw/77DUUnBecimz4yq3vCo15r1iasC0LHFdeudgBivJtQ(CD1/So9Mkrw6VNUXohv5L13333fNI9gm1Ioc/ZJGL1HLf0syJ7GokR
syplYwFqvNhu10upanRA=</ds:SignatureValue>
```

```

<ds:KeyInfo Id="_ f6fa91c7-ee9f-4702-8f08-820bd7a86ac2">
  <ds:X509Data>
    <ds:X509Certificate>MIID0CCARigAIBAgIBBTANBgkqhkiG9w0BAQsFAADBMQswCQYDVQQGEwJGUjeCMB0GA1UECgwTS2V5bWVjd
    GIzLU9wZW51cnVzdDEfMB0GA1UEAwMT3Blb1RydXN0IFRlc3Q0EgU0hBMjAeFw0xMjE0MDU3MzVaFw0xNDExMTUwMDU3MzVaMFgxCzAJBgNVB
    AYTAkLUMQ8wDQYDVQQKDAZPFRFRU1QXEjAQBgNVBAsMCU9VIFRFRU1QgMjESMBAGA1UECwwJT1UgVEVTVCAxMRawDgYDVQQDDADUZXXN0IENOMIIBIjANB
    gkqhkiG9w0BAQFAAQCAQ8AMIIBCGKCAQEAtnB/1lzF05cvQDI1zQJRsZZh9TK7AhLnxxnR2EP1hRnP7GRnksqyYMJECIL/4NntEhftQe7AGSaneX7X
    05GHJGd72NmFqazVjHyat8XSxaxUoG4kclF5QaDovvXUAHTtM2qVnjppFyKkTgbA5D7IQS36zTBYawCE40k9HU2/pvInG3jika60U4of9oqEQe+hh2
    IxkN01mRmxPunKyozWn3ggL/QQlH/yggkBDpLG2qmIUM09cvyvdyABW+5R56NyR42xVRCb56rvI5Qcbnbsrvkcbms1Gdo/qnKvxcThxstt3TqGq+kZ
    1CIHDo7sF8ZDQKuIjXNEgsurt/OHQIDAQABo4GwMIGTMB0GA1UdDgQIBBR57ehOf8/to6YtF04hEYcc1C0zoTAF8gNVHSMGDAWgBRRCv9bAGffzbq1T
    CZ0MpE7ji+fpTAR8g1ghkgBhvCAQEBAACB4AwDgYVR0PAAQ/BAQDAgBAMEGGA1UdHwRMD8wPAA7oDmGN2h0dHA6Ly9wa210ZXN0Lm9wZi50cnVzd
    C5j20vT3Blb1RydXN0X1Rlc3RfQ0F0U0hBMi5jcmwwdQYjKozIhvcNAQELBQADggEBAGNAu3Yo2Z9Ff1FLX/DHvcw8T5otZlayTj1HdyCetvhjy24vc
    XJzW8uHbFopvu91XZFuxXjG12SSyKsK4sRHfUVFPQdryAMGzMUW+OgjVfjupV54jr6vkaElQ2t6oyE52CHqv1HyLJz5CIW6jDEMAzGNJ2zWR4fu9z2M
    21m4X5JITsZGxY/JHO2f1155QJuVn7N5ffX8PXR8IKYNZ+Z7KcZNTSL9zDwYXob5PUBv60FXhWPtngz80I8NGQDVQIjtnbgcssgDchRMVv4JOU8UK
    7RAJpG4aR/SRkaMk06DLHXJteXfmskFlyDq3H8B+eHgfJJWCEYmVnqk755EVNE=</ds:X509Certificate>
  </ds:X509Data>
</ds:KeyInfo>
</ds:Signature>
</Sgntr>
</AppHdr>

<Document xmlns="urn:iso:std:iso:20022:tech:xsd:camt.050.001.05">
  <LqdyCdtTrf>
    <MsgHdr>
      <MsgId>NONREF</MsgId>
    </MsgHdr>
    <LqdyCdtTrf>
      <LqdyTrfId>
        <EndToEndId>Inc050b050-E2EId</EndToEndId>
      </LqdyTrfId>
      <CdtrAcct>
        <Id>
          <Othr>
            <Id>MDEURSOLADESTXXXSOLADESTXXX</Id>
          </Othr>
        </Id>
      </CdtrAcct>
      <TrfdAmt>
        <AmtwthCcy Ccy="EUR">100000.00</AmtwthCcy>
      </TrfdAmt>
      <DbtrAcct>
        <Id>
          <Othr>
            <Id>MDEURCOBADEFFXXXCOBADEFFXXX</Id>
          </Othr>
        </Id>
      </DbtrAcct>
    </LqdyCdtTrf>
  </LqdyCdtTrf>
</Document>

```

Figure 100 - Message type 2, complete example